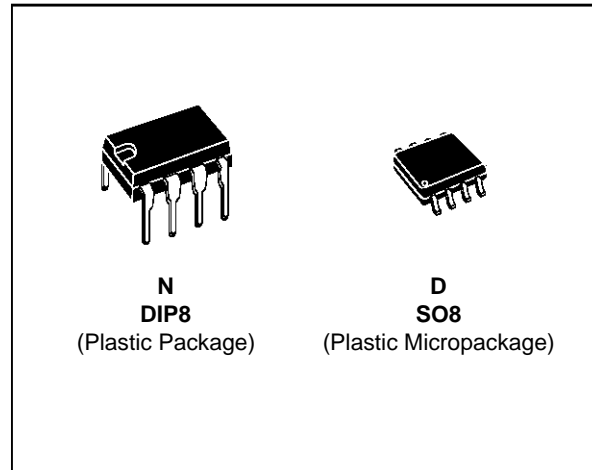


## PROGRAMMABLE CMOS SINGLE OPERATIONAL AMPLIFIERS

- OFFSET NULL CAPABILITY (by external compensation)
- DYNAMIC CHARACTERISTICS ADJUSTABLE BY  $I_{SET}$
- CONSUMPTION CURRENT AND DYNAMIC PARAMETERS ARE STABLE REGARDING THE VOLTAGE POWER SUPPLY VARIATIONS
- OUTPUT VOLTAGE CAN SWING TO GROUND
- VERY LARGE  $I_{SET}$  RANGE
- STABLE AND LOW OFFSET VOLTAGE
- THREE INPUT OFFSET VOLTAGE SELECTIONS



### DESCRIPTION

The TS271 is a low cost, low power single operational amplifier designed to operate with single or

dual supplies. This operational amplifier uses the SGS-THOMSON silicon gate CMOS process giving it an excellent consumption-speed ratio. This amplifier is ideally suited for low consumption applications.

The power supply is externally programmable with a resistor connected between pins 8 and 4. It allows to choose the best consumption-speed ratio and supply current can be minimized according to the required speed. This device is specified for the following  $I_{SET}$  current values : 1.5 $\mu$ A, 25 $\mu$ A, 130 $\mu$ A.

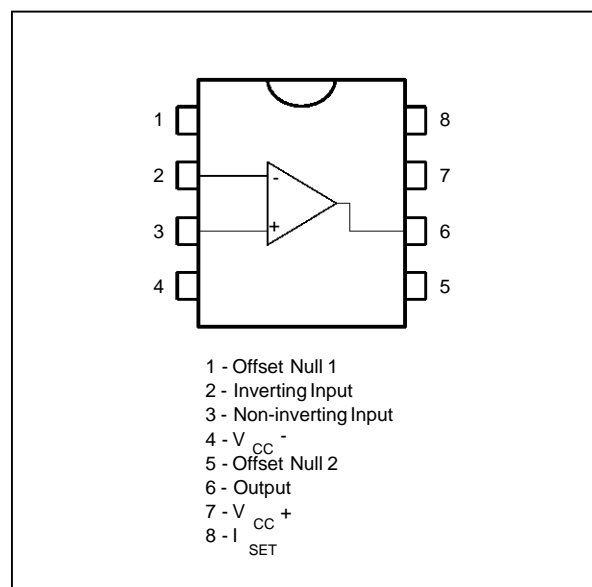
This CMOS amplifier offers very high input impedance and extremely low input currents. The major advantage versus JFET devices is the very low input currents drift with temperature (see figure 3).

### ORDER CODES

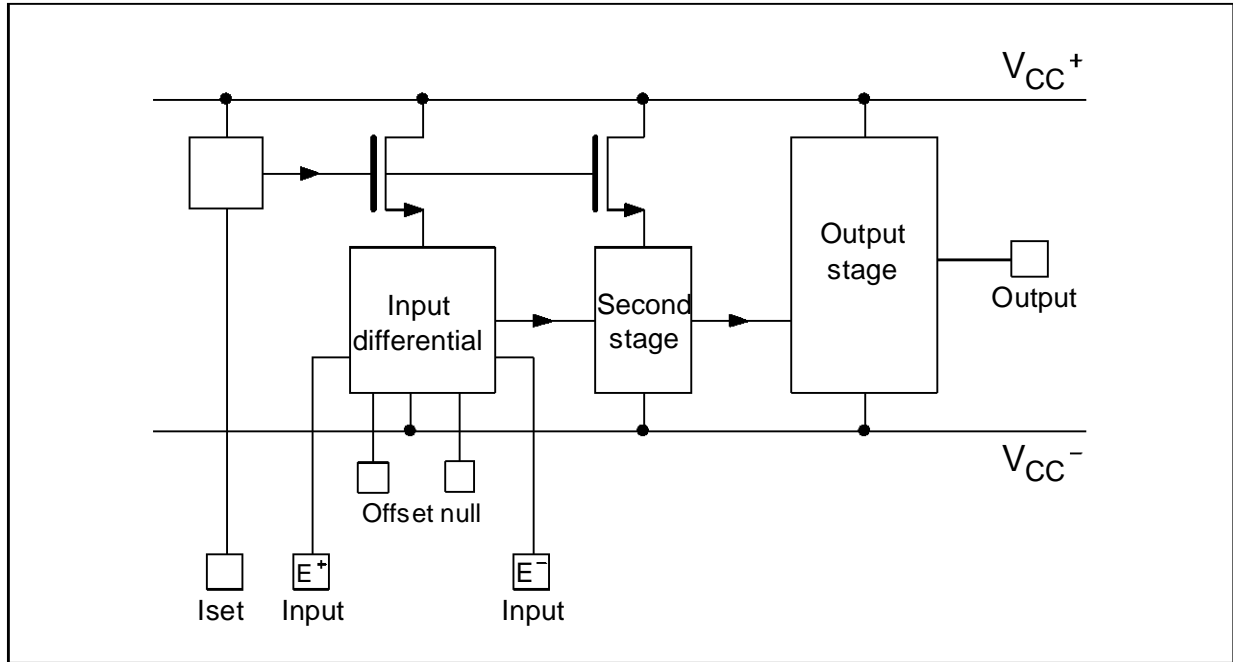
Part Number	Temperature Range	Package	
		N	D
TS271C/AC/BC	0°C, +70°C	●	●
TS271I/AI/BI	-40°C, +125°C	●	●
TS271M/AM/BM	-55°C, +125°C	●	●

**Example : TS271ACN**

### PIN CONNECTIONS (top view)



**BLOCK DIAGRAM**



**MAXIMUM RATINGS**

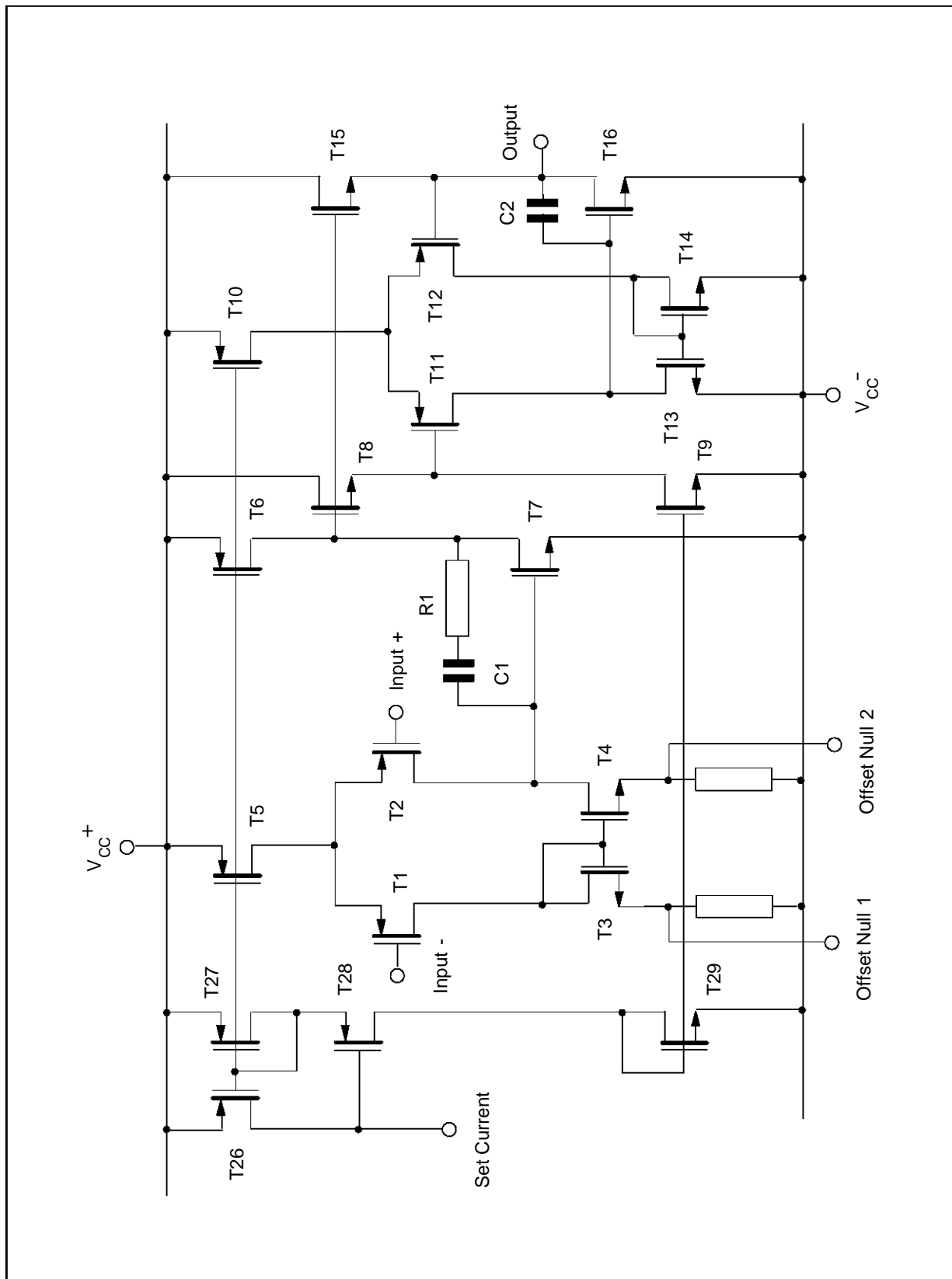
Symbol	Parameter	Value	Unit
$V_{CC}^+$	Supply Voltage - (note 1)	18	V
$V_{id}$	Differential Input Voltage - (note 2)	$\pm 18$	V
$V_i$	Input Voltage - (note 3)	-0.3 to 18	V
$I_o$	Output Current for $V_{CC}^+ \geq 15V$	$\pm 30$	mA
$I_{in}$	Input Current	$\pm 5$	mA
$T_{oper}$	Operating Free-Air Temperature Range	TS271C/AC/BC TS271I/AI/BI TS271M/AM/BM 0 to +70 -40 to +125 -55 to +125	$^{\circ}C$
$T_{stg}$	Storage Temperature Range	-65 to +150	$^{\circ}C$

Notes : 1. All voltage values, except differential voltage, are with respect to network ground terminal.  
 2. Differential voltages are the non-inverting input terminal with respect to the inverting input terminal.  
 3. The magnitude of the input and the output voltages must never exceed the magnitude of the positive supply voltage.

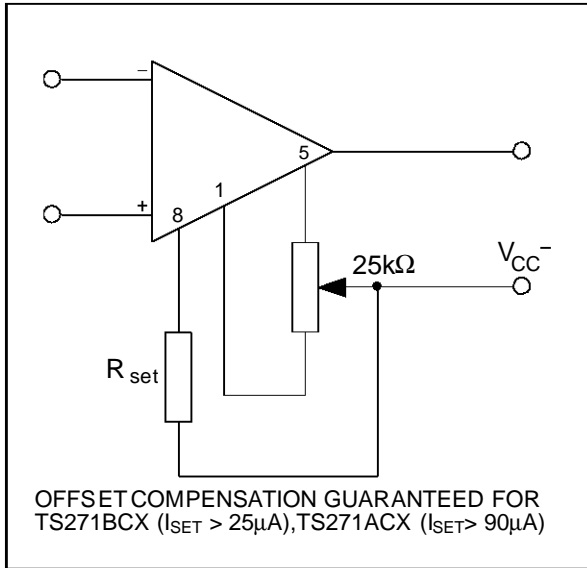
**OPERATING CONDITIONS**

Symbol	Parameter	Value	Unit
$V_{CC}^+$	Supply Voltage	3 to 16	V
$V_{icm}$	Common Mode Input Voltage Range	0 to $V_{CC}^+ - 1.5$	V

**SCHEMATIC DIAGRAM**



OFFSET VOLTAGE NULL CIRCUIT



RESISTOR BIASING

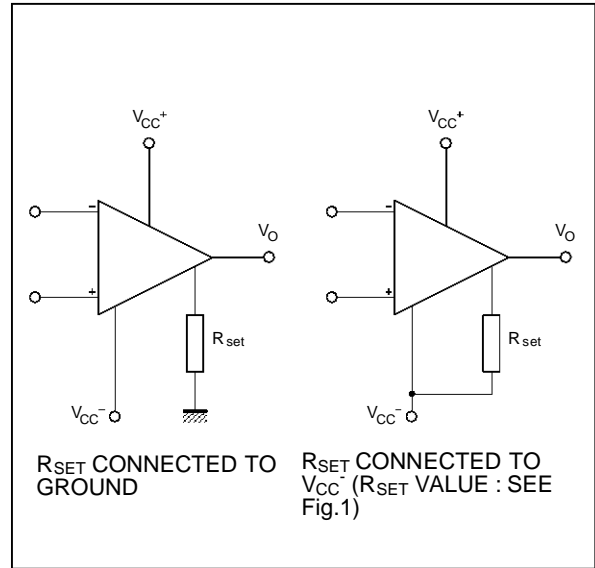
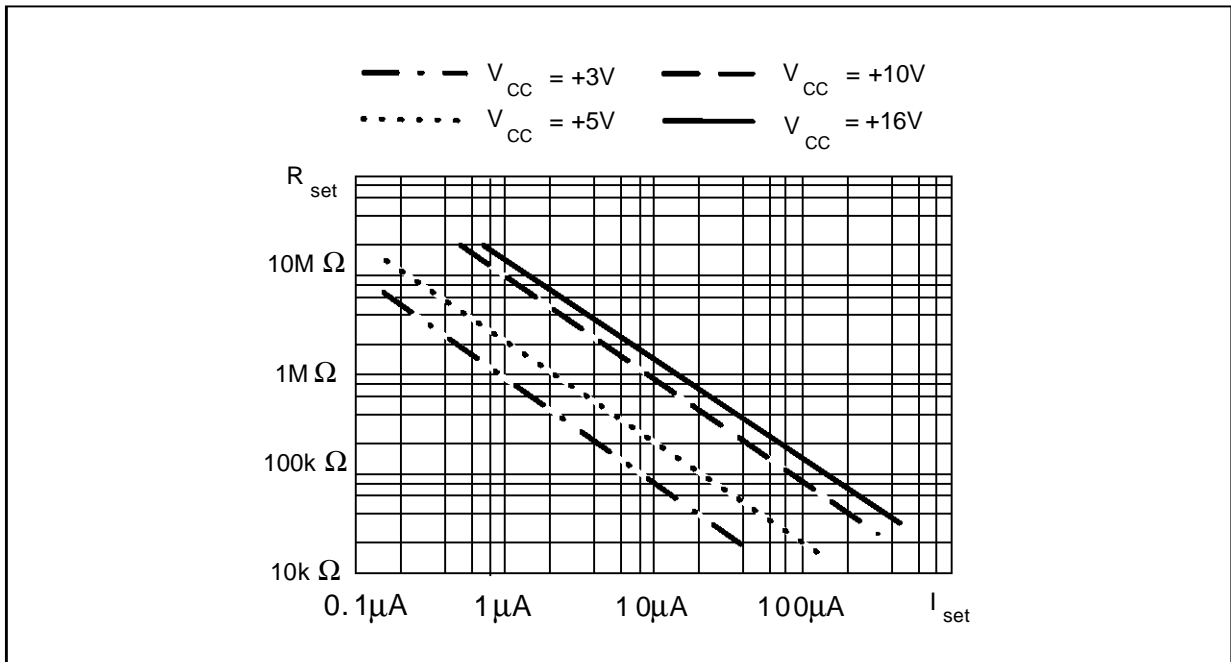


Figure 1 :  $R_{SET}$  Connected to  $V_{CC}^-$ .



**ELECTRICAL CHARACTERISTICS FOR  $I_{SET} = 1.5\mu A$** 
 $V_{CC}^+ = +10V, V_{CC}^- = 0V, T_{amb} = 25^\circ C$  (unless otherwise specified)

Symbol	Parameter	TS271C/AC/BC			TS271I/AI/BI TS271M/AM/BM			Unit
		Min.	Typ.	Max.	Min.	Typ.	Max.	
$V_{io}$	Input Offset Voltage $V_O = 1.4V, V_{ic} = 0V$ TS271C/I/M TS271AC/AI/AM TS271BC/BI/BM  $T_{min.} \leq T_{amb} \leq T_{max.}$ TS271C/I/M TS271AC/AI/AM TS271BC/BI/BM		1.1 0.9 0.25	10 5 2		1.1 0.9 0.25	10 5 2	mV
$DV_{io}$	Input Offset Voltage Drift		0.7			0.7		$\mu V/^\circ C$
$I_{io}$	Input Offset Current - (note 1) $V_{ic} = 5V, V_o = 5V$ $T_{min.} \leq T_{amb} \leq T_{max.}$		1	100		1	200	pA
$I_{ib}$	Input Bias Current - (note 1) $V_{ic} = 5V, V_o = 5V$ $T_{min.} \leq T_{amb} \leq T_{max.}$		1	150		1	300	pA
$V_{OH}$	High Level Output Voltage $V_{id} = 100mV, R_L = 1M\Omega$ $T_{min.} \leq T_{amb} \leq T_{max.}$	8.8 8.7	9		8.8 8.6	9		V
$V_{OL}$	Low Level Output Voltage ( $V_{id} = -100mV$ )			50			50	mV
$A_{vd}$	Large Signal Voltage Gain $V_o = 1V$ to $6V, R_L = 1M\Omega, V_{ic} = 5V$ $T_{min.} \leq T_{amb} \leq T_{max.}$	30 20	100		30 20	100		V/mV
GBP	Gain Bandwidth Product ( $A_v = 40dB,$ $R_L = 1M\Omega, C_L = 100pF, f_{in} = 10kHz$ )		0.1			0.1		MHz
CMR	Common Mode Rejection Ratio $V_o = 1.4V, V_{ic} = 1V$ to $7.4V$	60	80		60	80		dB
SVR	Supply Voltage Rejection Ratio $V_{CC}^+ = 5V$ to $10V, V_o = 1.4V$	60	80		60	80		dB
$I_{cc}$	Supply Current $A_v = 1, \text{no load}, V_o = 5V$ $T_{min.} \leq T_{amb} \leq T_{max.}$		10	15 17		10	15 18	$\mu A$
$I_o$	Output Short Circuit Current $V_{id} = 100mV, V_o = 0V$		60			60		mA
$I_{sink}$	Output Sink Current $V_{id} = -100mV, V_o = V_{CC}$		45			45		mA
SR	Slew-Rate at Unity Gain $R_L = 1M\Omega, C_L = 100pF, V_i = 3$ to $7V$		0.04			0.04		V/ $\mu s$
$\phi_m$	Phase Margin at Unity Gain $A_v = 40dB, R_L = 1M\Omega$ $C_L = 10pF$ $C_L = 100pF$		35 10			35 10		Degrees
$K_{ov}$	Overshoot Factor $C_L = 10pF$ $C_L = 100pF$		40 70			40 70		%
$e_n$	Equivalent Input Noise Voltage $f = 1kHz, R_S = 100\Omega$		68			68		$\frac{nV}{\sqrt{Hz}}$

**Note :** 1. Maximum values including unavoidable inaccuracies of the industrial test.

TYPICAL CHARACTERISTICS FOR  $I_{SET} = 1.5\mu A$

Figure 2 : Supply Current versus Supply Voltage

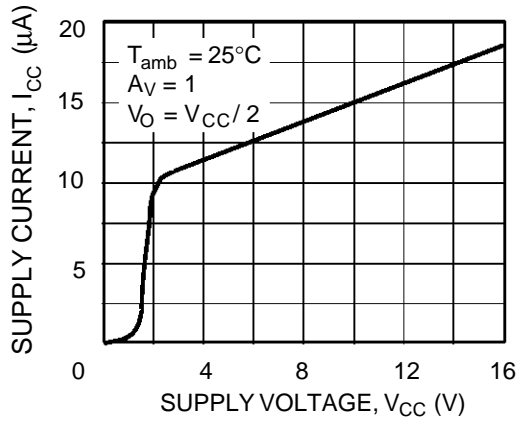


Figure 3 : Input Bias Current versus Free Air Temperature

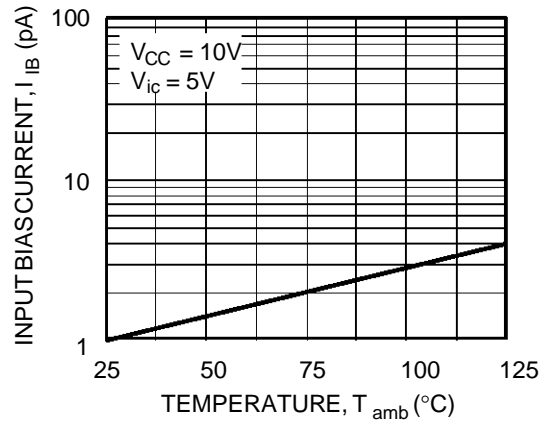


Figure 4a : High Level Output Voltage versus High Level Output Current

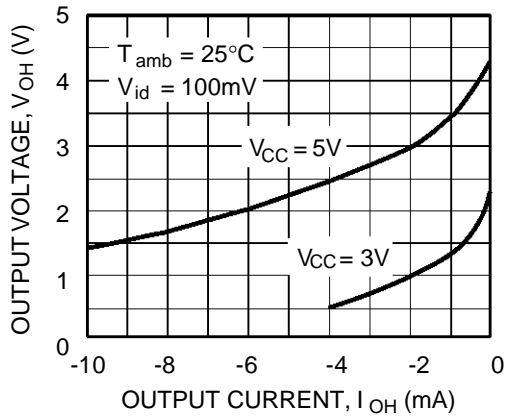


Figure 4b : High Level Output Voltage versus High Level Output Current

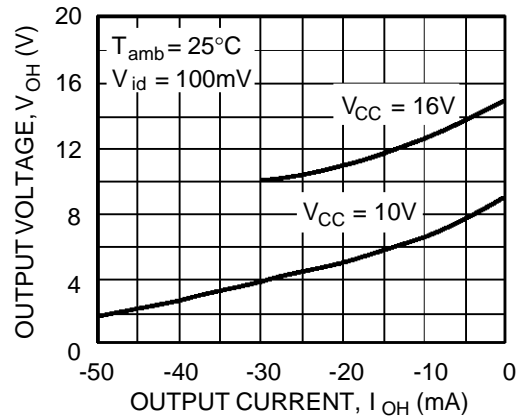


Figure 5a : Low Level Output Voltage versus Low Level Output Current

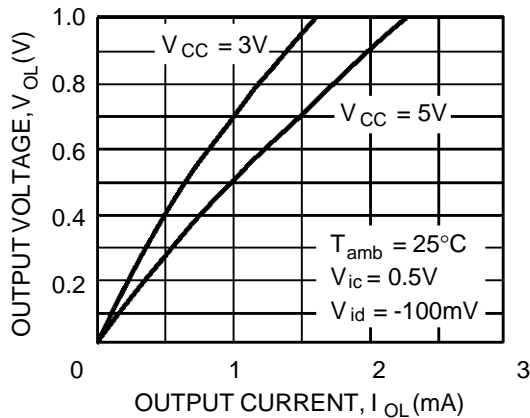
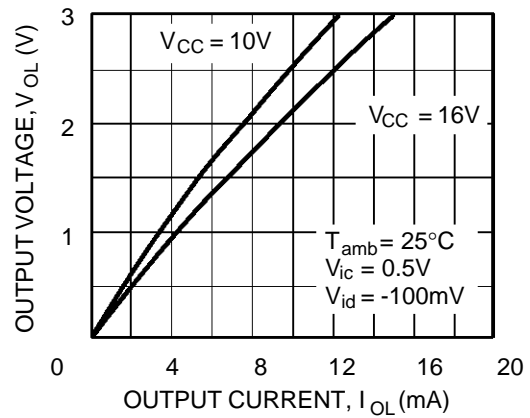
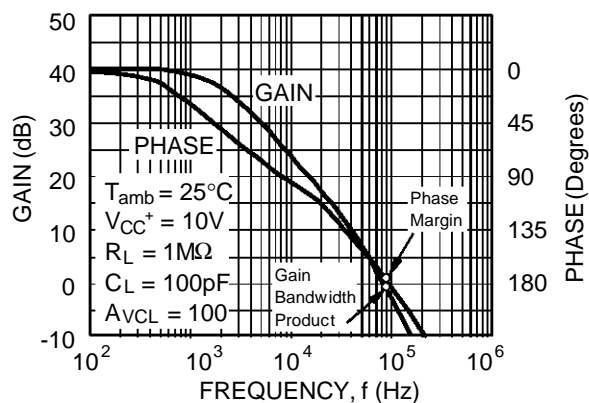


Figure 5b : Low Level Output Voltage versus Low Level Output Current

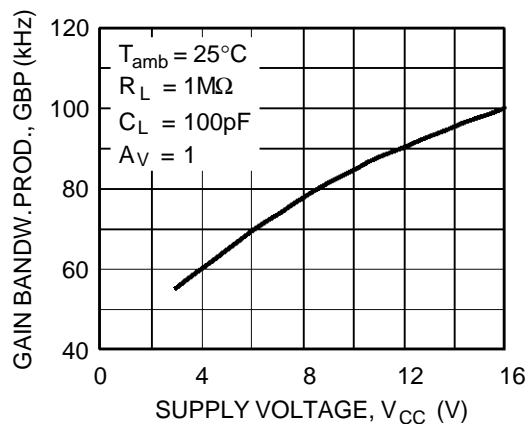


TYPICAL CHARACTERISTICS FOR  $I_{SET} = 1.5\mu A$  (continued)

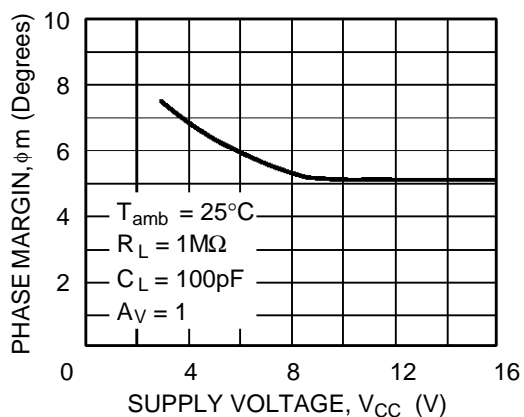
**Figure 6 :** Open Loop Frequency Response and Phase Shift



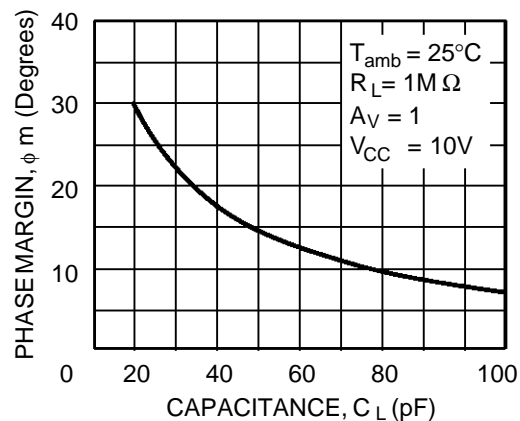
**Figure 7 :** Gain Bandwidth Product versus Supply voltage



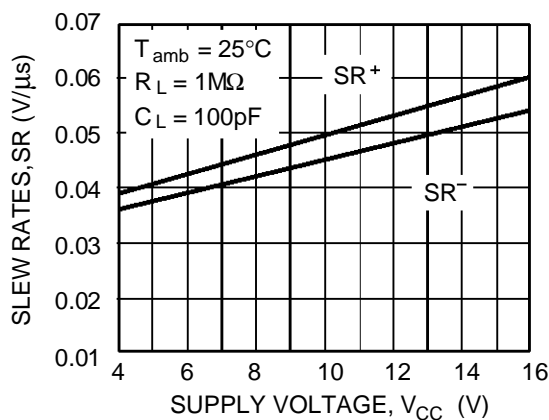
**Figure 8 :** Phase Margin versus Supply Voltage



**Figure 9 :** Phase Margin versus Capacitive Load



**Figure 10 :** Slew Rates versus Supply Voltage



## TS271C,I,M

### ELECTRICAL CHARACTERISTICS FOR $I_{SET} = 25\mu A$

$V_{CC}^+ = +10V$ ,  $V_{CC}^- = 0V$ ,  $T_{amb} = 25^\circ C$  (unless otherwise specified)

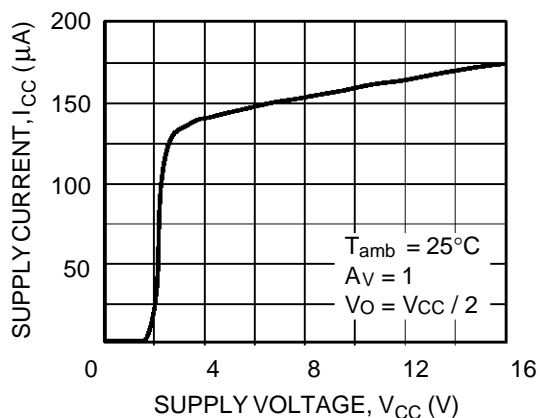
Symbol	Parameter	TS271C/AC/BC			TS271I/AI/BI TS271M/AM/BM			Unit
		Min.	Typ.	Max.	Min.	Typ.	Max.	
$V_{io}$	Input Offset Voltage $V_O = 1.4V$ , $V_{ic} = 0V$ TS271C/I/M TS271AC/AI/AM TS271BC/BI/BM  $T_{min.} \leq T_{amb} \leq T_{max.}$ TS271C/I/M TS271AC/AI/AM TS271BC/BI/BM		1.1 0.9 0.25	10 5 2		1.1 0.9 0.25	10 5 2	mV
$DV_{io}$	Input Offset Voltage Drift		2			2		$\mu V/^\circ C$
$I_{io}$	Input Offset Current - (note 1) $V_{ic} = 5V$ , $V_o = 5V$ $T_{min.} \leq T_{amb} \leq T_{max.}$		1	100		1	200	pA
$I_{ib}$	Input Bias Current - (note 1) $V_{ic} = 5V$ , $V_o = 5V$ $T_{min.} \leq T_{amb} \leq T_{max.}$		1	150		1	300	pA
$V_{OH}$	High Level Output Voltage $V_{id} = 100mV$ , $R_L = 100k\Omega$ $T_{min.} \leq T_{amb} \leq T_{max.}$	8.7 8.6	8.9		8.7 8.5	8.9		V
$V_{OL}$	Low Level Output Voltage ( $V_{id} = -100mV$ )			50			50	mV
$A_{vd}$	Large Signal Voltage Gain $V_o = 1V$ to $6V$ , $R_L = 100k\Omega$ , $V_{ic} = 5V$ $T_{min.} \leq T_{amb} \leq T_{max.}$	30 20	50		30 10	50		V/mV
GBP	Gain Bandwidth Product ( $A_v = 40dB$ , $R_L = 100k\Omega$ , $C_L = 100pF$ , $f_{in} = 100kHz$ )		0.7			0.7		MHz
CMR	Common Mode Rejection Ratio $V_o = 1.4V$ , $V_{ic} = 1V$ to $7.4V$	60	80		60	80		dB
SVR	Supply Voltage Rejection Ratio $V_{CC}^+ = 5V$ to $10V$ , $V_o = 1.4V$	60	80		60	80		dB
$I_{cc}$	Supply Current $A_v = 1$ , no load, $V_o = 5V$ $T_{min.} \leq T_{amb} \leq T_{max.}$		150	200 250		150	200 300	$\mu A$
$I_o$	Output Short Circuit Current $V_{id} = 100mV$ , $V_o = 0V$		60			60		mA
$I_{sink}$	Output Sink Current $V_{id} = -100mV$ , $V_o = V_{CC}$		45			45		mA
SR	Slew-Rate at Unity Gain $R_L = 100k\Omega$ , $C_L = 100pF$ , $V_i = 3$ to $7V$		0.6			0.6		V/ $\mu s$
$\phi_m$	Phase Margin at Unity Gain $A_v = 40dB$ , $R_L = 100k\Omega$ $C_L = 10pF$ $C_L = 100pF$		50 30			50 30		degrees
$K_{ov}$	Overshoot Factor $C_L = 10pF$ $C_L = 100pF$		30 50			30 50		%
$e_n$	Equivalent Input Noise Voltage $f = 1kHz$ , $R_S = 100\Omega$		38			38		$\frac{nV}{\sqrt{Hz}}$

**Note :** 1. Maximum values including unavoidable inaccuracies of the industrial test.

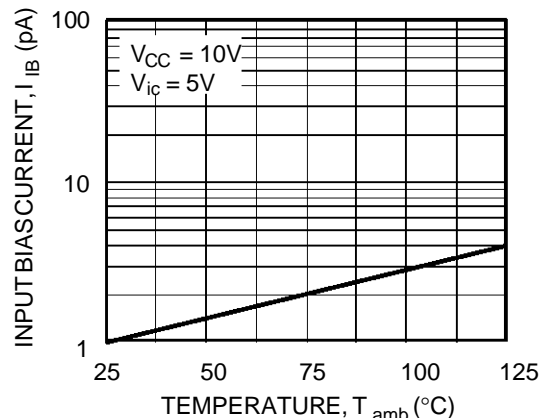


**TYPICAL CHARACTERISTICS FOR  $I_{SET} = 25\mu A$**

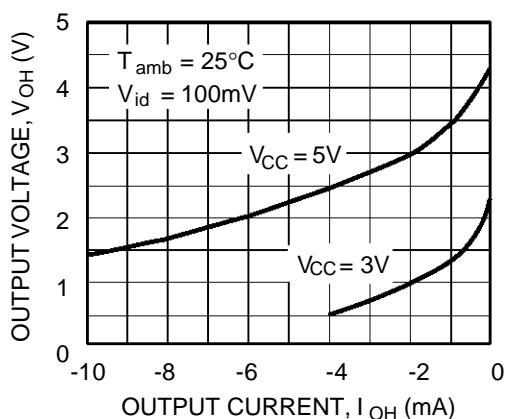
**Figure 11 :** Supply Current versus Supply Voltage



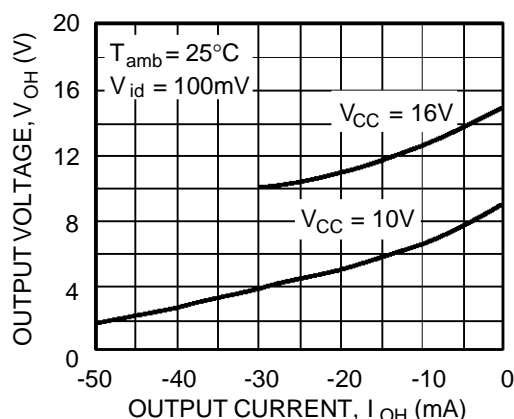
**Figure 12 :** Input Bias Current versus Free Air Temperature



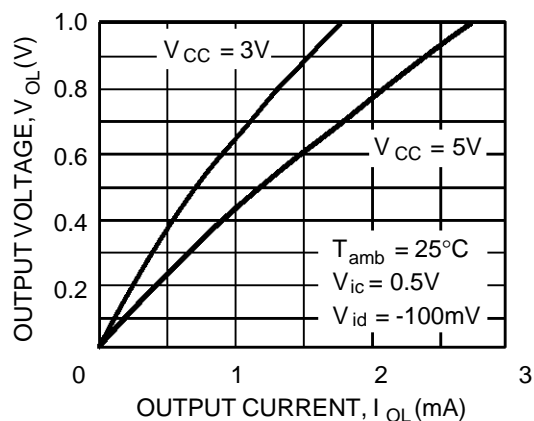
**Figure 13a :** High Level Output Voltage versus High Level Output Current



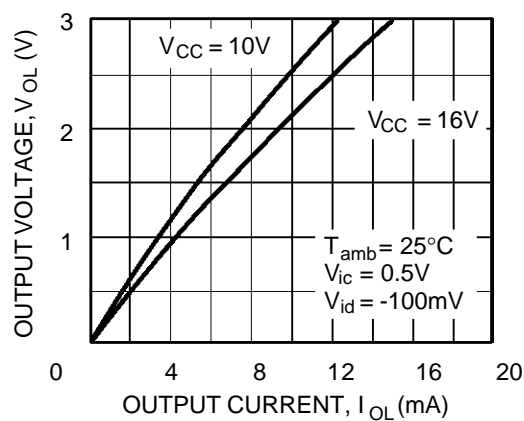
**Figure 13b :** High Level Output Voltage versus High Level Output Current



**Figure 14a :** Low Level Output Voltage versus Low Level Output Current



**Figure 14b :** Low Level Output Voltage versus Low Level Output Current



TYPICAL CHARACTERISTICS FOR  $I_{SET} = 25\mu A$  (continued)

Figure 15 : Open Loop Frequency Response and Phase Shift

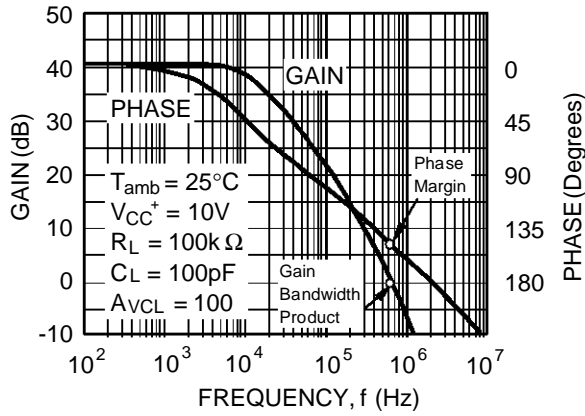


Figure 16 : Gain Bandwidth Product versus Supply Voltage

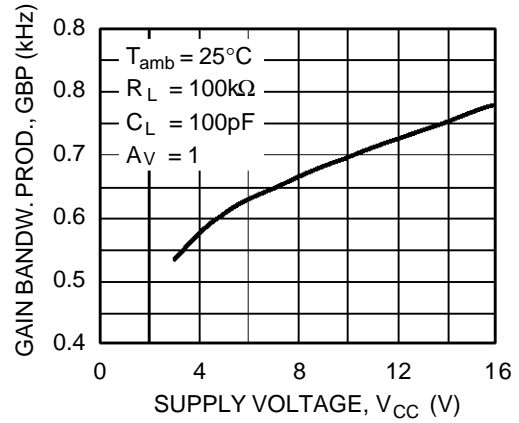


Figure 17 : Phase Margin versus Supply Voltage

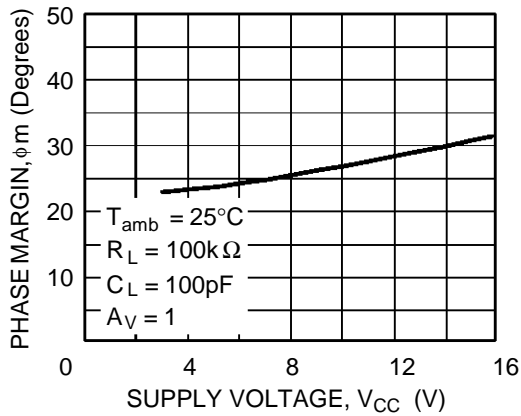


Figure 18 : Phase Margin versus Capacitive Load

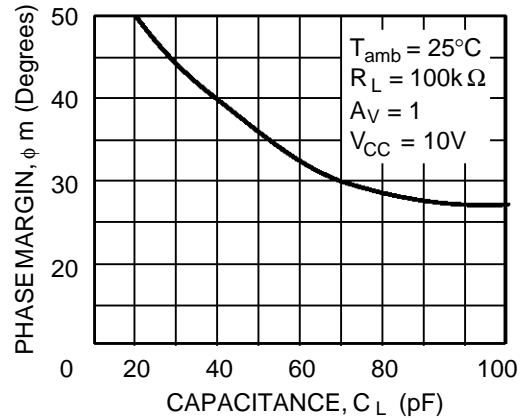
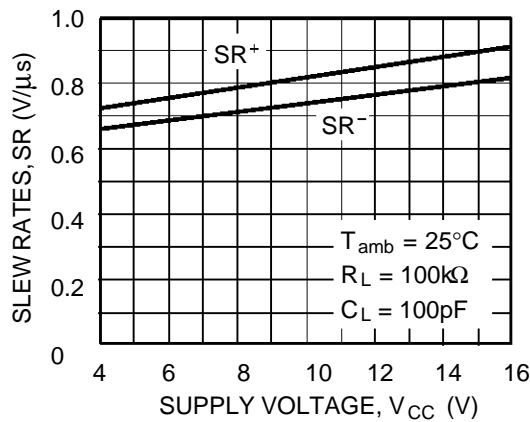


Figure 19 : Slew Rates versus Supply Voltage



**ELECTRICAL CHARACTERISTICS FOR I<sub>SET</sub> = 130μA**

V<sub>CC</sub><sup>+</sup> = +10V, V<sub>CC</sub><sup>-</sup> = 0V, T<sub>amb</sub> = 25°C (unless otherwise specified)

Symbol	Parameter	TS271C/AC/BC			TS271I/AI/BI TS271M/AM/BM			Unit
		Min.	Typ.	Max.	Min.	Typ.	Max.	
V <sub>io</sub>	Input Offset Voltage V <sub>O</sub> = 1.4V, V <sub>ic</sub> = 0V TS271C/I/M TS271AC/AI/AM TS271BC/BI/BM  T <sub>min.</sub> ≤ T <sub>amb</sub> ≤ T <sub>max.</sub> TS271C/I/M TS271AC/AI/AM TS271BC/BI/BM		1.1 0.9 0.25	10 5 2		1.1 0.9 0.25	10 5 2	mV
DV <sub>io</sub>	Input Offset Voltage Drift		2			2		μV/°C
I <sub>io</sub>	Input Offset Current - (note 1) V <sub>ic</sub> = 5V, V <sub>o</sub> = 5V T <sub>min.</sub> ≤ T <sub>amb</sub> ≤ T <sub>max.</sub>		1	100		1	200	pA
I <sub>ib</sub>	Input Bias Current - (note 1) V <sub>ic</sub> = 5V, V <sub>o</sub> = 5V T <sub>min.</sub> ≤ T <sub>amb</sub> ≤ T <sub>max.</sub>		1	150		1	300	pA
V <sub>OH</sub>	High Level Output Voltage V <sub>id</sub> = 100mV, R <sub>L</sub> = 10kΩ T <sub>min.</sub> ≤ T <sub>amb</sub> ≤ T <sub>max.</sub>	8.2 8.1	8.4		8.2 8	8.4		V
V <sub>OL</sub>	Low Level Output Voltage (V <sub>id</sub> = -100mV)			50			50	mV
A <sub>vd</sub>	Large Signal Voltage Gain V <sub>o</sub> = 1V to 6V, R <sub>L</sub> = 10kΩ, V <sub>ic</sub> = 5V T <sub>min.</sub> ≤ T <sub>amb</sub> ≤ T <sub>max.</sub>	10 7	15		10 6	15		V/mV
GBP	Gain Bandwidth Product (A <sub>v</sub> = 40dB, R <sub>L</sub> = 10kΩ, C <sub>L</sub> = 100pF, f <sub>in</sub> = 100kHz)		2.3			2.3		MHz
CMR	Common Mode Rejection Ratio V <sub>o</sub> = 1.4V, V <sub>ic</sub> = 1V to 7.4V	60	80		60	80		dB
SVR	Supply Voltage Rejection Ratio V <sub>CC</sub> <sup>+</sup> = 5V to 10V, V <sub>o</sub> = 1.4V	60	70		60	70		dB
I <sub>cc</sub>	Supply Current A <sub>v</sub> = 1, no load, V <sub>o</sub> = 5V T <sub>min.</sub> ≤ T <sub>amb</sub> ≤ T <sub>max.</sub>		800	1300 1400		800	1300 1500	μA
I <sub>o</sub>	Output Short Circuit Current V <sub>id</sub> = 100mV, V <sub>o</sub> = 0V		60			60		mA
I <sub>sink</sub>	Output Sink Current V <sub>id</sub> = -100mV, V <sub>o</sub> = V <sub>CC</sub>		45			45		mA
SR	Slew-Rate at Unity Gain R <sub>L</sub> = 10kΩ, C <sub>L</sub> = 100pF, V <sub>i</sub> = 3 to 7V		4.5			4.5		V/μs
∅ <sub>m</sub>	Phase Margin at Unity Gain A <sub>v</sub> = 40dB, R <sub>L</sub> = 10kΩ C <sub>L</sub> = 10pF C <sub>L</sub> = 100pF		65 50			65 50		degrees
K <sub>ov</sub>	Overshoot Factor C <sub>L</sub> = 10pF C <sub>L</sub> = 100pF		30 30			30 30		%
e <sub>n</sub>	Equivalent Input Noise Voltage f = 1kHz, R <sub>S</sub> = 100Ω		30			30		$\frac{nV}{\sqrt{Hz}}$

**Note :** 1. Maximum values including unavoidable inaccuracies of the industrial test.

TYPICAL CHARACTERISTICS FOR  $I_{SET} = 130\mu A$

Figure 20 : Supply Current (each amplifier) versus Supply Voltage

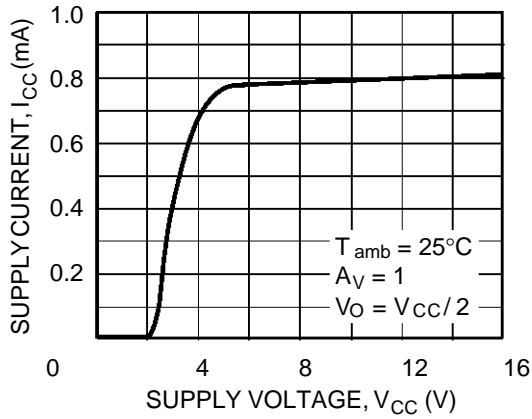


Figure 21 : Input Bias Current versus Free Air Temperature

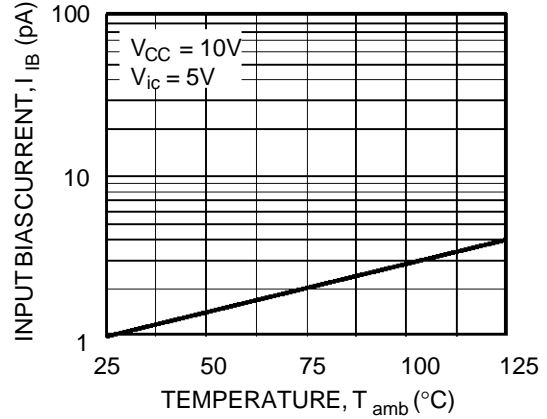


Figure 22a : High Level Output Voltage versus High Level Output Current

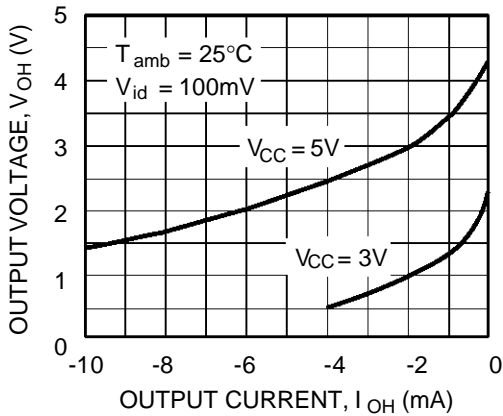


Figure 22b : High Level Output Voltage versus High Level Output Current

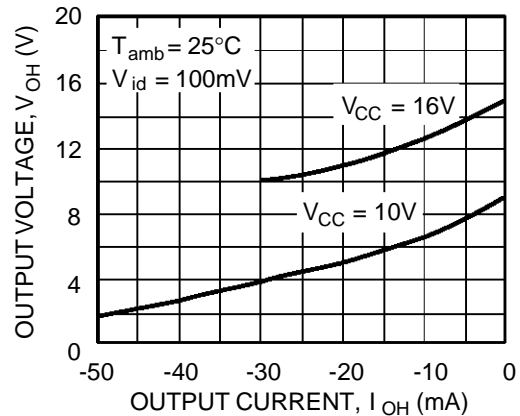


Figure 23a : Low Level Output Voltage versus Low Level Output Current

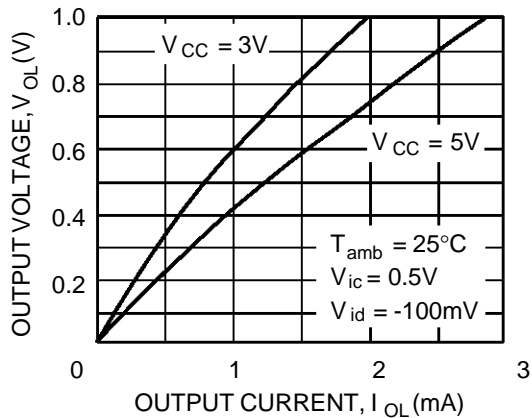
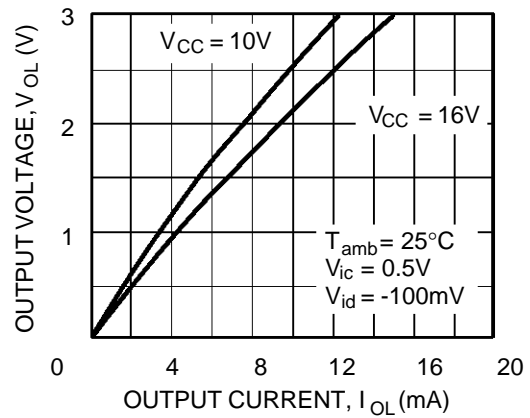
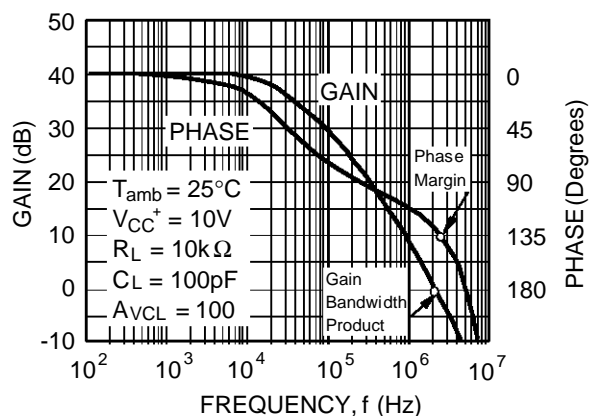


Figure 23b : Low Level Output Voltage versus Low Level Output Current

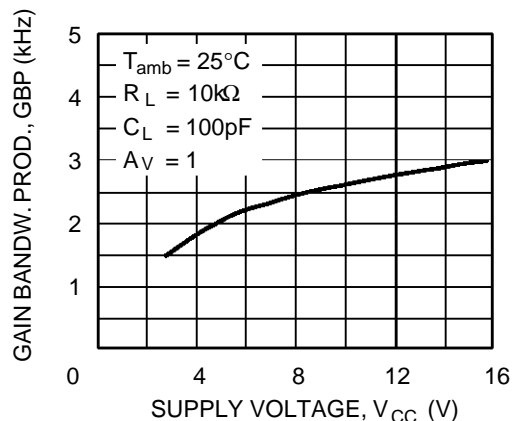


TYPICAL CHARACTERISTICS FOR  $I_{SET} = 130\mu A$  (continued)

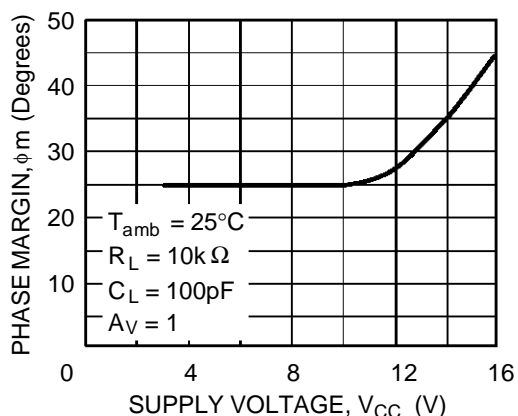
**Figure 24 :** Open Loop Frequency Response and Phase Shift



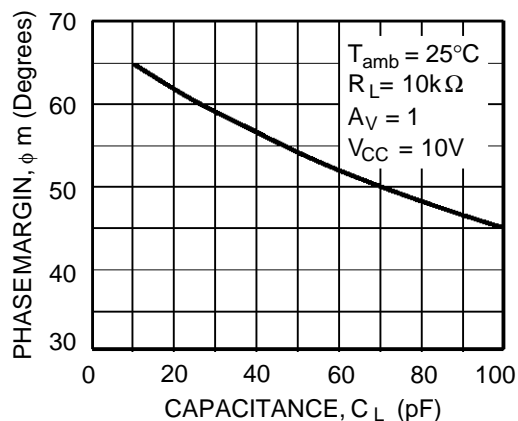
**Figure 25 :** Gain Bandwidth Product versus Supply voltage



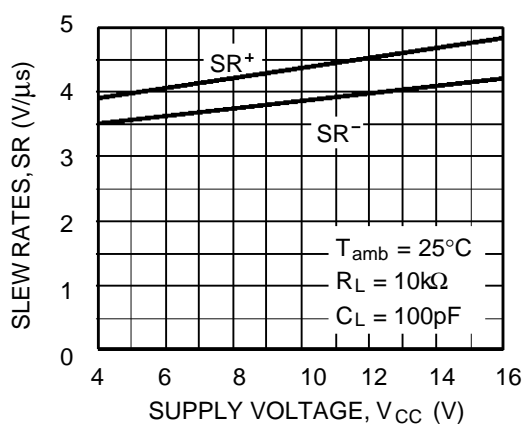
**Figure 26 :** Phase Margin versus Supply Voltage



**Figure 27 :** Phase Margin versus Capacitive Load

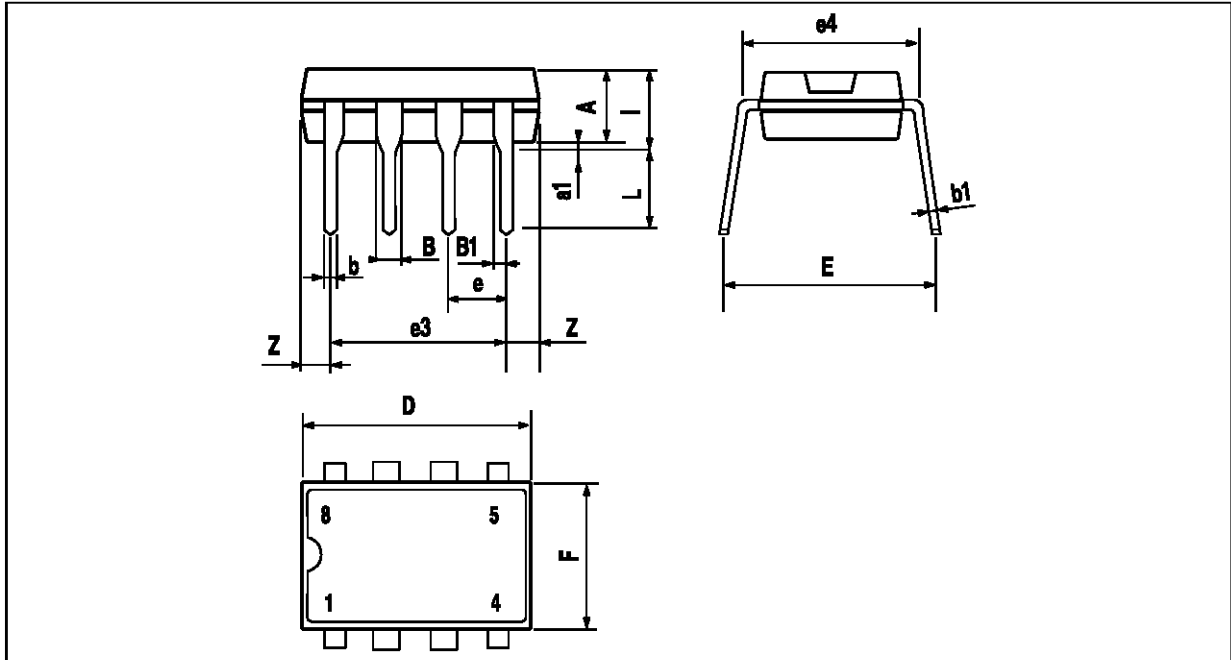


**Figure 28 :** Slew Rates versus Supply Voltage



**TS271C,I,M**

**PACKAGE MECHANICAL DATA**  
8 PINS - PLASTIC DIP

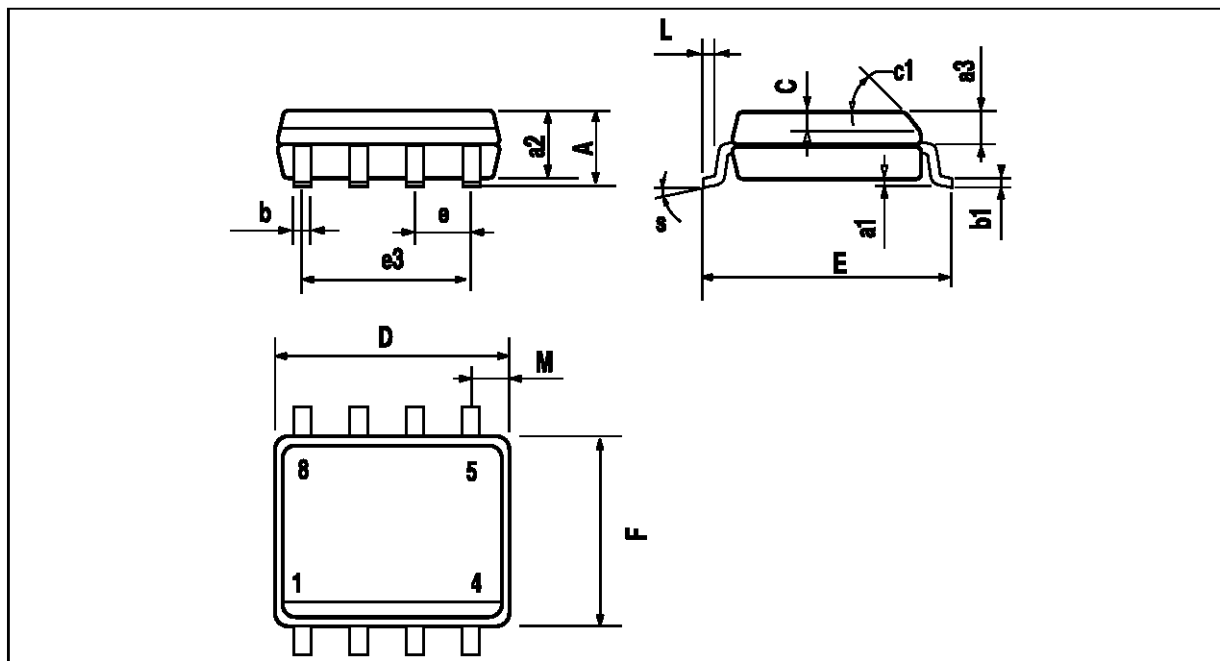


PM-DIP8.EPS

Dimensions	Millimeters			Inches		
	Min.	Typ.	Max.	Min.	Typ.	Max.
A		3.32			0.131	
a1	0.51			0.020		
B	1.15		1.65	0.045		0.065
b	0.356		0.55	0.014		0.022
b1	0.204		0.304	0.008		0.012
D			10.92			0.430
E	7.95		9.75	0.313		0.384
e		2.54			0.100	
e3		7.62			0.300	
e4		7.62			0.300	
F			6.6			0.260
i			5.08			0.200
L	3.18		3.81	0.125		0.150
Z			1.52			0.060

271-07.TBL

**PACKAGE MECHANICAL DATA**  
8 PINS - PLASTIC MICROPACKAGE (SO)



PM-S08.EPS

Dimensions	Millimeters			Inches		
	Min.	Typ.	Max.	Min.	Typ.	Max.
A			1.75			0.069
a1	0.1		0.25	0.004		0.010
a2			1.65			0.065
a3	0.65		0.85	0.026		0.033
b	0.35		0.48	0.014		0.019
b1	0.19		0.25	0.007		0.010
C	0.25		0.5	0.010		0.020
c1	45° (typ.)					
D	4.8		5.0	0.189		0.197
E	5.8		6.2	0.228		0.244
e		1.27			0.050	
e3		3.81			0.150	
F	3.8		4.0	0.150		0.157
L	0.4		1.27	0.016		0.050
M			0.6			0.024
S	8° (max.)					

S08.TBL

Information furnished is believed to be accurate and reliable. However, SGS-THOMSON Microelectronics assumes no responsibility for the consequences of use of such information nor for any infringement of patents or other rights of third parties which may result from its use. No license is granted by implication or otherwise under any patent or patent rights of SGS-THOMSON Microelectronics. Specification mentioned in this publication are subject to change without notice. This publication supersedes and replaces all information previously supplied. SGS-THOMSON Microelectronics products are not authorized for use as critical components in life support devices or systems without express written approval of SGS-THOMSON Microelectronics.

© 1997 SGS-THOMSON Microelectronics – Printed in Italy – All Rights Reserved

SGS-THOMSON Microelectronics GROUP OF COMPANIES  
Australia - Brazil - Canada - China - France - Germany - Hong Kong - Italy - Japan - Korea - Malaysia - Malta - Morocco  
The Netherlands - Singapore - Spain - Sweden - Switzerland - Taiwan - Thailand - United Kingdom - U.S.A.

ORDER CODE :