

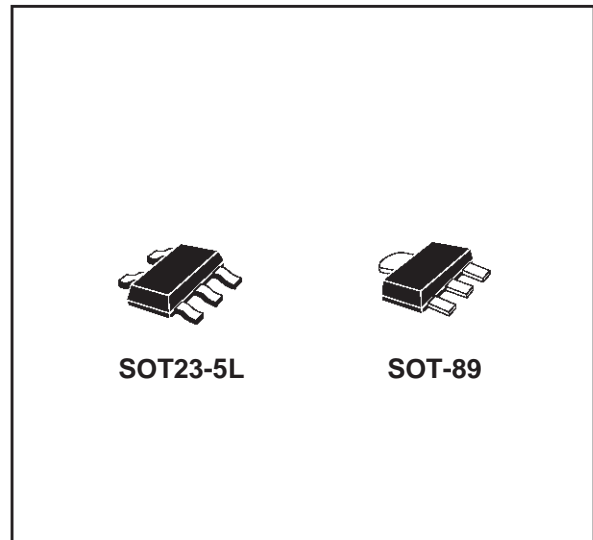

## VERY LOW DROP VOLTAGE REGULATORS WITH INHIBIT

- ULTRA LOW DROPOUT VOLTAGE (0.12V TYP. AT 50mA LOAD)
- VERY LOW QUIESCENT CURRENT (MAX 1 $\mu$ A IN OFF MODE; TYP. 375 $\mu$ A AT 50mA LOAD)
- OUTPUT CURRENT UP TO 50 mA
- LOGIC-CONTROLLED ELECTRONIC SHUTDOWN
- OUTPUT VOLTAGES OF 2.85; 3.0; 3.2; 3.3; 3.8; 4.85; 5.0V
- INTERNAL CURRENT AND THERMAL LIMIT
- AVAILABLE IN  $\pm 0.5\%$  TOLLERANCE (AT 25 $^{\circ}$ C, A VERSION)
- SUPPLY VOLTAGE REJECTION: 63dB (TYP)
- ONLY 1 $\mu$ F FOR STABILITY
- TEMPERATURE RANGE: -40 TO 125  $^{\circ}$ C
- SMALLEST PACKAGES SOT23-5L AND SOT-89
- FAST DYNAMIC RESPONSE TO LINE AND LOAD CHANGES



quiescent current make them particularly suitable for low noise, low power applications and in battery powered systems.

Shutdown Logic Control function is available on pin n. 3 (TTL compatible). This means that when the device is used as local regulator, it is possible to put a part of the board in standby, decreasing the total power consumption.

### DESCRIPTION

The LD2980 series are very Low Drop regulators available in SOT23-5L and SOT-89 packages. The ultra low drop-voltage and the very low

### SCHEMATIC DIAGRAM

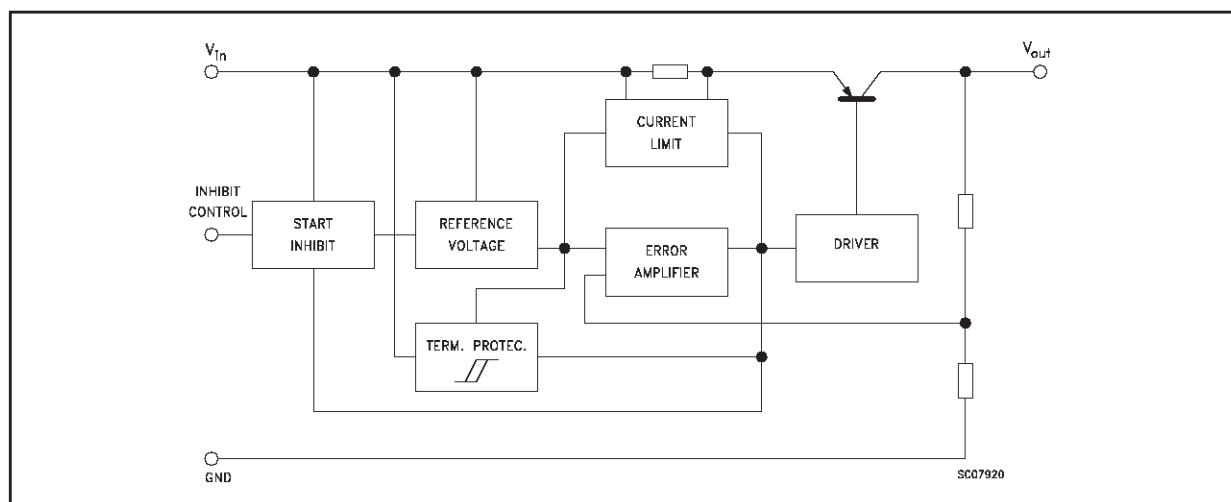

# LD2980

## ABSOLUTE MAXIMUM RATING

Symbol	Parameter	Value	Unit
$V_{IN}$	DC Input Voltage	16	V
$V_{INH}$	INHBIT Input Voltage	16	V
$I_o$	Output Current	Internally limited	mA
$P_{tot}$	Power Dissipation	Internally limited	mW
$T_{stg}$	Storage Temperature Range	- 55 to 150	°C
$T_{op}$	Operating Junction Temperature Range	- 40 to 125	°C

## THERMAL DATA

Symbol	Parameter	SOT-89	SOT23-5L	Unit
$R_{thj-case}$	Thermal Resistance Junction-case	15	81	°C/W

## CONNECTION DIAGRAM (top view)

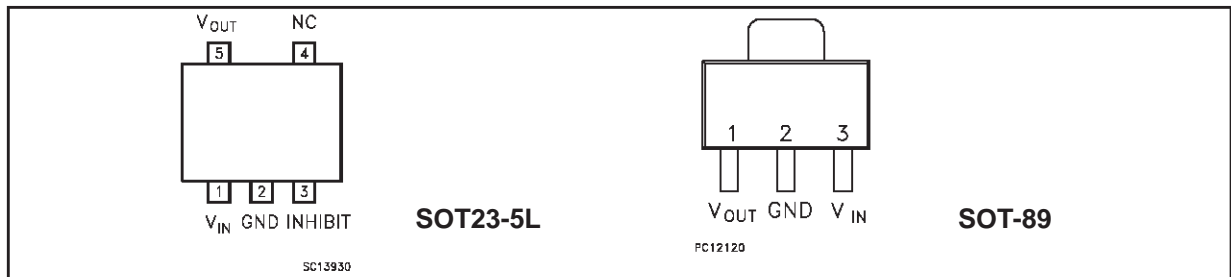

(\*) Inhibit pin is not internally pulled-up then it must not be left floating. Disable the device when connected to GND or to a positive voltage less than 0.18V

## ORDERING NUMBERS

AB VERSION		C VERSION		Output Voltage
SOT23-5L	SOT-89	SOT23-5L	SOT-89	
LD2980ABM28TR	LD2980ABU28TR	LD2980CM28TR	LD2980CU28TR	2.85 V
LD2980ABM30TR	LD2980ABU30TR	LD2980CM30TR	LD2980CU30TR	3.0 V
LD2980ABM32TR	LD2980ABU32TR	LD2980CM32TR	LD2980CU32TR	3.2 V
LD2980ABM33TR	LD2980ABU33TR	LD2980CM33TR	LD2980CU33TR	3.3 V
LD2980ABM38TR	LD2980ABU38TR	LD2980CM38TR	LD2980CU38TR	3.8 V
LD2980ABM48TR	LD2980ABU48TR	LD2980CM48TR	LD2980CU48TR	4.85 V
LD2980ABM50TR	LD2980ABU50TR	LD2980CM50TR	LD2980CU50TR	5.0 V

## APPLICATION CIRCUIT

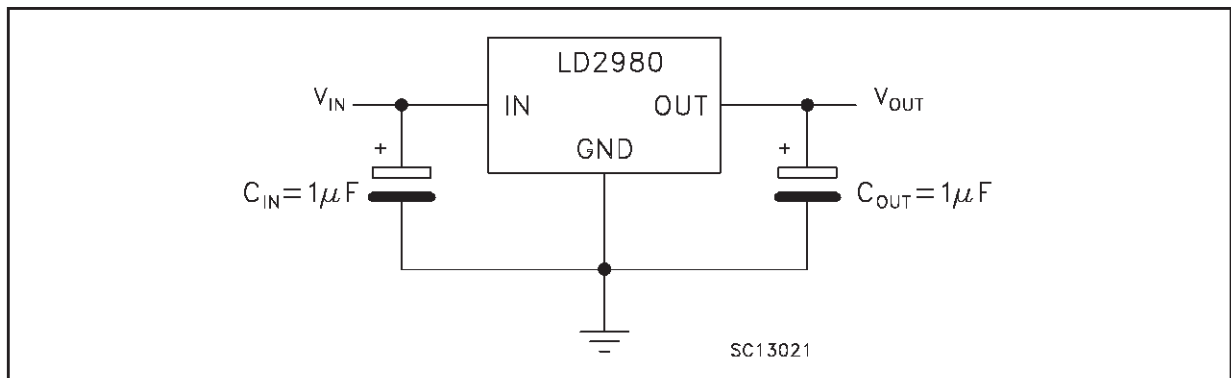

**ELECTRICAL CHARACTERISTICS FOR LD2980AB** (refer to the test circuits,  $T_J = 25\text{ }^\circ\text{C}$ ,  
 $V_{IN} = V_{O(NOM)} + 1$ ,  $C_O = 1\text{ }\mu\text{F}$ ,  $I_O = 1\text{ mA}$ ,  $V_{inh} = 2\text{ V}$ , unless otherwise specified)

Symbol	Parameter	Test Conditions	Min.	Typ.	Max.	Unit
$V_o$	Output Voltage	$V_{IN} = 3.85\text{ V}$	2.835	2.85	2.865	V
		$1 < I_o < 50\text{ mA}$	2.828		2.872	V
		$1 < I_o < 50\text{ mA}, -40 < T_J < 125\text{ }^\circ\text{C}$	2.778		2.922	V
$V_o$	Output Voltage	$V_{IN} = 4\text{ V}$	2.985	3	3.015	V
		$1 < I_o < 50\text{ mA}$	2.977		3.023	V
		$1 < I_o < 50\text{ mA}, -40 < T_J < 125\text{ }^\circ\text{C}$	2.925		3.075	V
$V_o$	Output Voltage	$V_{IN} = 4.2\text{ V}$	3.184	3.2	3.216	V
		$1 < I_o < 50\text{ mA}$	3.175		3.225	V
		$1 < I_o < 50\text{ mA}, -40 < T_J < 125\text{ }^\circ\text{C}$	3.12		3.28	V
$V_o$	Output Voltage	$V_{IN} = 4.3\text{ V}$	3.283	3.3	3.317	V
		$1 < I_o < 50\text{ mA}$	3.275		3.325	V
		$1 < I_o < 50\text{ mA}, -40 < T_J < 125\text{ }^\circ\text{C}$	3.217		3.383	V
$V_o$	Output Voltage	$V_{IN} = 4.8\text{ V}$	3.781	3.8	3.819	V
		$1 < I_o < 50\text{ mA}$	3.771		3.829	V
		$1 < I_o < 50\text{ mA}, -40 < T_J < 125\text{ }^\circ\text{C}$	3.705		3.895	V
$V_o$	Output Voltage	$V_{IN} = 5.85\text{ V}$	4.825	4.85	4.875	V
		$1 < I_o < 50\text{ mA}$	4.813		4.887	V
		$1 < I_o < 50\text{ mA}, -40 < T_J < 125\text{ }^\circ\text{C}$	4.729		4.971	V
$V_o$	Output Voltage	$V_{IN} = 6\text{ V}$	4.975	5	5.025	V
		$1 < I_o < 50\text{ mA}$	4.962		5.038	V
		$1 < I_o < 50\text{ mA}, -40 < T_J < 125\text{ }^\circ\text{C}$	4.875		5.125	V
$I_{out}$	Output Current Limit	$R_L = 0$	150			mA
$\Delta V_o$	Line Regulation	$V_{O(NOM)} + 1 < V_{IN} < 16\text{ V}, I_o = 1\text{ mA}$ $-40 < T_J < 125\text{ }^\circ\text{C}$		0.003	0.014	%/ $V_{in}$
$I_d$	Quiescent Current	ON MODE				
		$I_o = 0\text{ mA}$		65	95	$\mu\text{A}$
		$I_o = 0\text{ mA}, -40 < T_J < 125\text{ }^\circ\text{C}$			125	$\mu\text{A}$
		$I_o = 1\text{ mA}$		80	110	$\mu\text{A}$
		$I_o = 1\text{ mA}, -40 < T_J < 125\text{ }^\circ\text{C}$			170	$\mu\text{A}$
		$I_o = 10\text{ mA}$		140	220	$\mu\text{A}$
		$I_o = 10\text{ mA}, -40 < T_J < 125\text{ }^\circ\text{C}$			460	$\mu\text{A}$
		$I_o = 50\text{ mA}$		375	600	$\mu\text{A}$
		$I_o = 50\text{ mA}, -40 < T_J < 125\text{ }^\circ\text{C}$			1200	$\mu\text{A}$
		OFF MODE				
$V_{INH} < 0.18\text{ V}$		0		$\mu\text{A}$		
$V_{INH} < 0.18\text{ V}, -40 < T_J < 125\text{ }^\circ\text{C}$			1	$\mu\text{A}$		
SVR	Supply Voltage Rejection	$f = 1\text{ KHz}, C_{out} = 10\text{ }\mu\text{F}$		63		dB
$V_d$	Dropout Voltage	$I_o = 0\text{ mA}$		1	3	mV
		$I_o = 0\text{ mA}, -40 < T_J < 125\text{ }^\circ\text{C}$			5	mV
		$I_o = 1\text{ mA}$		7	10	mV
		$I_o = 1\text{ mA}, -40 < T_J < 125\text{ }^\circ\text{C}$			15	mV
		$I_o = 10\text{ mA}$		40	60	mV
		$I_o = 10\text{ mA}, -40 < T_J < 125\text{ }^\circ\text{C}$			90	mV
		$I_o = 50\text{ mA}$		120	150	mV
$I_o = 50\text{ mA}, -40 < T_J < 125\text{ }^\circ\text{C}$			225	mV		
$V_{il}$	Control Input Logic Low	LOW = Output OFF $-40 < T_J < 125\text{ }^\circ\text{C}$			0.18	V
$V_{ih}$	Control Input Logic High	HIGH = Output ON $-40 < T_J < 125\text{ }^\circ\text{C}$	2			V
$I_i$	Control Input Current	$V_{INH} = 0\text{ V}$		0	-1	$\mu\text{A}$
		$V_{INH} = 5\text{ V}, -40 < T_J < 125\text{ }^\circ\text{C}$		5	15	$\mu\text{A}$
eN	Output Noise Voltage (RMS)	$BW = 300\text{ Hz to } 50\text{ KHz}, C_{out} = 10\text{ }\mu\text{F}$		160		$\mu\text{V}$

**ELECTRICAL CHARACTERISTICS FOR LD2980C** (refer to the test circuits,  $T_J = 25\text{ }^\circ\text{C}$ ,  
 $V_{IN} = V_{O(NOM)} + 1$ ,  $C_O = 1\text{ }\mu\text{F}$ ,  $I_O = 1\text{ mA}$ ,  $V_{inh} = 2\text{ V}$ , unless otherwise specified)

Symbol	Parameter	Test Conditions	Min.	Typ.	Max.	Unit
$V_o$	Output Voltage	$V_{IN} = 3.85\text{ V}$	2.821	2.85	2.879	V
		$1 < I_o < 50\text{ mA}$	2.807		2.893	V
		$1 < I_o < 50\text{ mA}, -40 < T_J < 125\text{ }^\circ\text{C}$	2.750		2.950	V
$V_o$	Output Voltage	$V_{IN} = 4\text{ V}$	2.970	3	3.030	V
		$1 < I_o < 50\text{ mA}$	2.955		3.045	V
		$1 < I_o < 50\text{ mA}, -40 < T_J < 125\text{ }^\circ\text{C}$	2.895		3.105	V
$V_o$	Output Voltage	$V_{IN} = 4.2\text{ V}$	3.168	3.2	3.232	V
		$1 < I_o < 50\text{ mA}$	3.152		3.248	V
		$1 < I_o < 50\text{ mA}, -40 < T_J < 125\text{ }^\circ\text{C}$	3.088		3.312	V
$V_o$	Output Voltage	$V_{IN} = 4.3\text{ V}$	3.267	3.3	3.333	V
		$1 < I_o < 50\text{ mA}$	3.250		3.350	V
		$1 < I_o < 50\text{ mA}, -40 < T_J < 125\text{ }^\circ\text{C}$	3.184		3.416	V
$V_o$	Output Voltage	$V_{IN} = 4.8\text{ V}$	3.762	3.8	3.838	V
		$1 < I_o < 50\text{ mA}$	3.743		3.857	V
		$1 < I_o < 50\text{ mA}, -40 < T_J < 125\text{ }^\circ\text{C}$	3.667		3.933	V
$V_o$	Output Voltage	$V_{IN} = 5.85\text{ V}$	4.800	4.85	4.900	V
		$1 < I_o < 50\text{ mA}$	4.777		4.923	V
		$1 < I_o < 50\text{ mA}, -40 < T_J < 125\text{ }^\circ\text{C}$	4.680		5.020	V
$V_o$	Output Voltage	$V_{IN} = 6\text{ V}$	4.950	5	5.050	V
		$1 < I_o < 50\text{ mA}$	4.925		5.075	V
		$1 < I_o < 50\text{ mA}, -40 < T_J < 125\text{ }^\circ\text{C}$	4.825		5.175	V
$I_{out}$	Output Current Limit	$R_L = 0$	150			mA
$\Delta V_o$	Line Regulation	$V_{O(NOM)} + 1 < V_{IN} < 16\text{ V}, I_o = 1\text{ mA}$ $-40 < T_J < 125\text{ }^\circ\text{C}$		0.003	0.014	%/ $V_{in}$
$I_d$	Quiescent Current	ON MODE				
		$I_o = 0\text{ mA}$		65	95	$\mu\text{A}$
		$I_o = 0\text{ mA}, -40 < T_J < 125\text{ }^\circ\text{C}$			125	$\mu\text{A}$
		$I_o = 1\text{ mA}$		80	110	$\mu\text{A}$
		$I_o = 1\text{ mA}, -40 < T_J < 125\text{ }^\circ\text{C}$			170	$\mu\text{A}$
		$I_o = 10\text{ mA}$		140	220	$\mu\text{A}$
		$I_o = 10\text{ mA}, -40 < T_J < 125\text{ }^\circ\text{C}$			460	$\mu\text{A}$
		$I_o = 50\text{ mA}$		375	600	$\mu\text{A}$
		$I_o = 50\text{ mA}, -40 < T_J < 125\text{ }^\circ\text{C}$			1200	$\mu\text{A}$
		OFF MODE				
$V_{INH} < 0.18\text{ V}$		0		$\mu\text{A}$		
$V_{INH} < 0.18\text{ V}, -40 < T_J < 125\text{ }^\circ\text{C}$			1	$\mu\text{A}$		
SVR	Supply Voltage Rejection	$f = 1\text{ KHz}, C_{out} = 10\text{ }\mu\text{F}$		63		dB
$V_d$	Dropout Voltage	$I_o = 0\text{ mA}$		1	3	mV
		$I_o = 0\text{ mA}, -40 < T_J < 125\text{ }^\circ\text{C}$			5	mV
		$I_o = 1\text{ mA}$		7	10	mV
		$I_o = 1\text{ mA}, -40 < T_J < 125\text{ }^\circ\text{C}$			15	mV
		$I_o = 10\text{ mA}$		40	60	mV
		$I_o = 10\text{ mA}, -40 < T_J < 125\text{ }^\circ\text{C}$			90	mV
		$I_o = 50\text{ mA}$		120	150	mV
$I_o = 50\text{ mA}, -40 < T_J < 125\text{ }^\circ\text{C}$			225	mV		
$V_{il}$	Control Input Logic Low	LOW = Output OFF $-40 < T_J < 125\text{ }^\circ\text{C}$			0.18	V
$V_{ih}$	Control Input Logic High	HIGH = Output ON $-40 < T_J < 125\text{ }^\circ\text{C}$	2			V
$I_i$	Control Input Current	$V_{INH} = 0\text{ V}$		0	-1	$\mu\text{A}$
		$V_{INH} = 5\text{ V}, -40 < T_J < 125\text{ }^\circ\text{C}$		5	15	$\mu\text{A}$
eN	Output Noise Voltage (RMS)	$BW = 300\text{ Hz to } 50\text{ KHz}, C_{out} = 10\text{ }\mu\text{F}$		160		$\mu\text{V}$

**TYPICAL PERFORMANCE CHARACTERISTICS** (unless otherwise specified  $T_J=25^\circ\text{C}$ ,  $C_{IN}=C_{OUT}=1\mu\text{F}$ )

Output Voltage vs Temperature

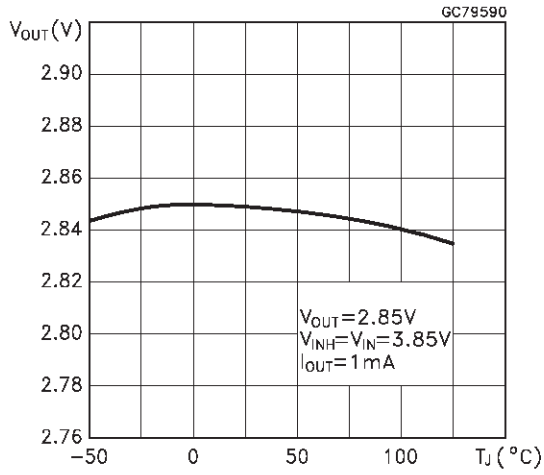

Output Voltage vs Temperature

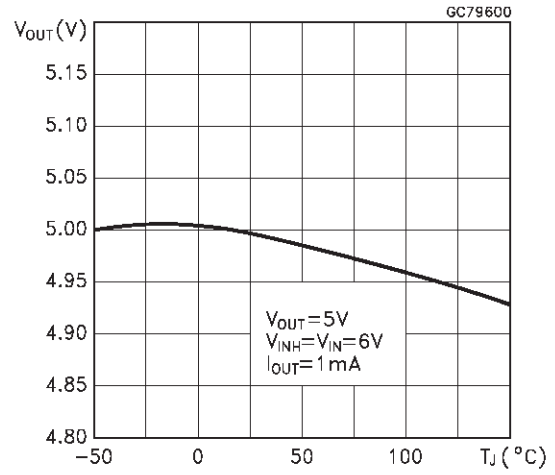

Output Voltage vs Input Voltage

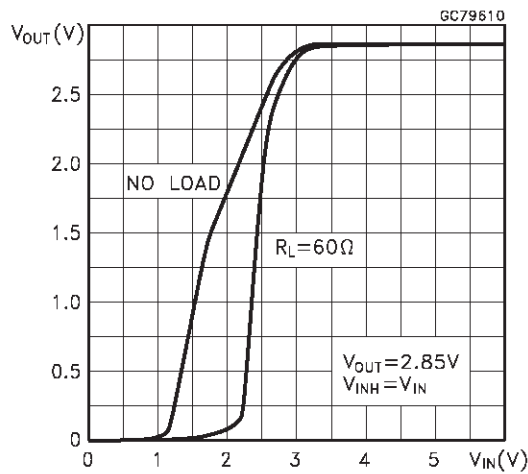

Output Voltage vs Input Voltage

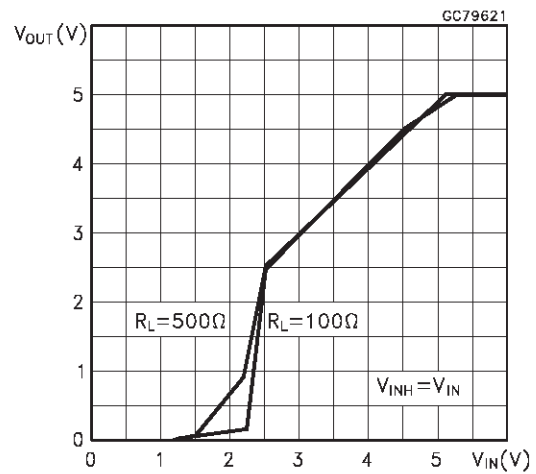

Line Regulation vs Temperature

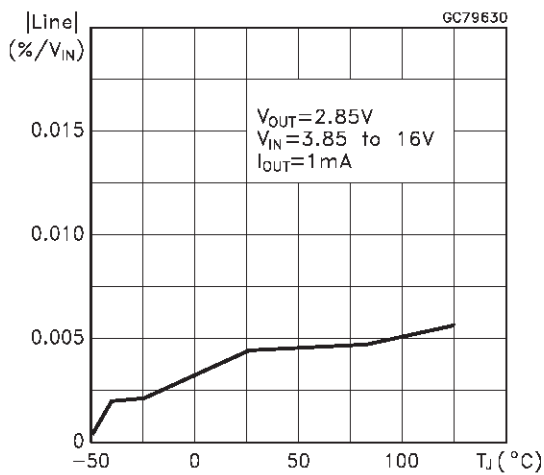

Dropout Voltage vs Temperature

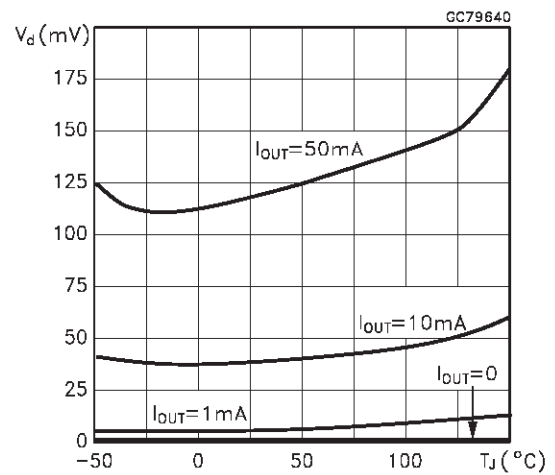

TYPICAL PERFORMANCE CHARACTERISTICS (continued)

Dropout Voltage vs Output Current

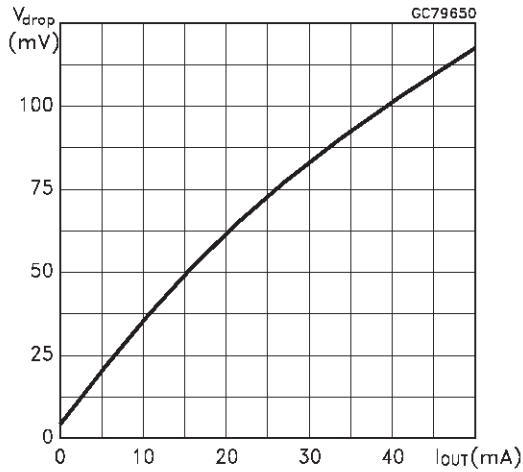

Quiescent Current vs Temperature

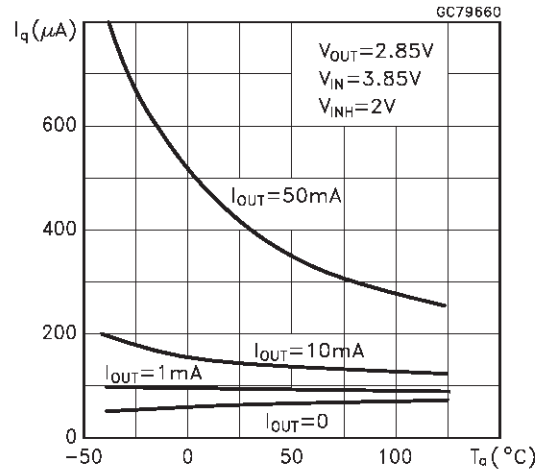

Quiescent Current vs Output Current

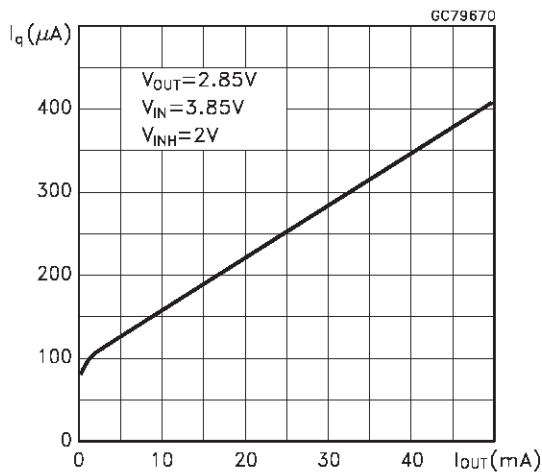

S.V.R. vs Frequency

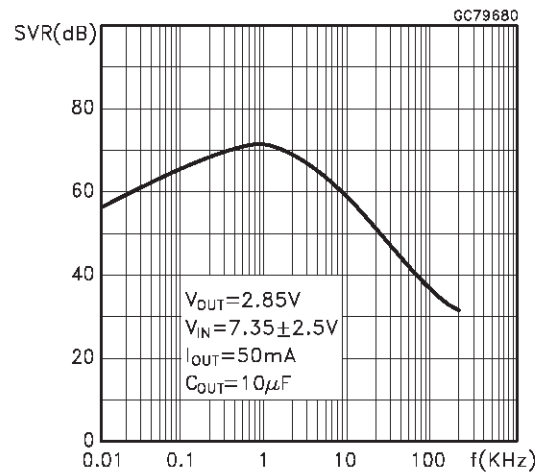

S.V.R. vs Temperature

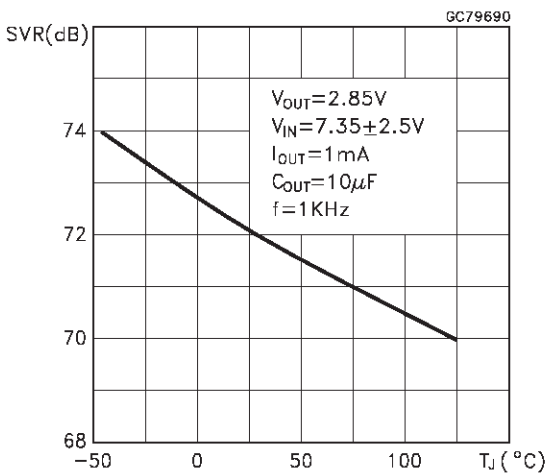

S.V.R. vs Output Current

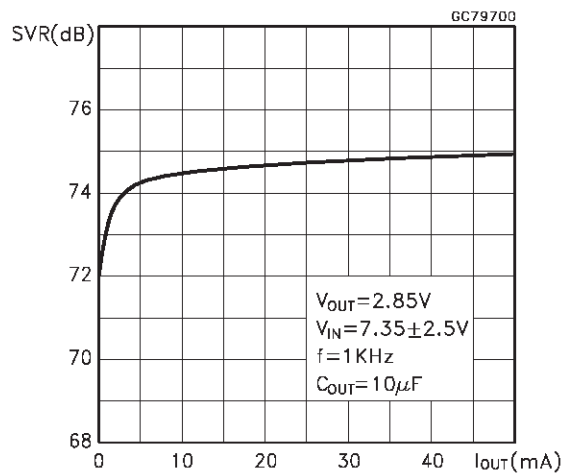

TYPICAL PERFORMANCE CHARACTERISTICS (continued)

Stability

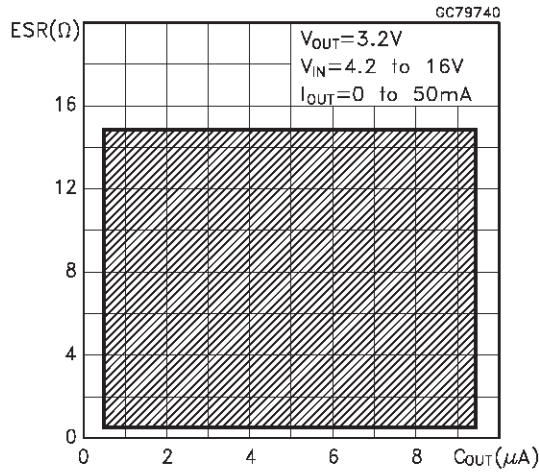

Reverse Current vs Reverse Voltage

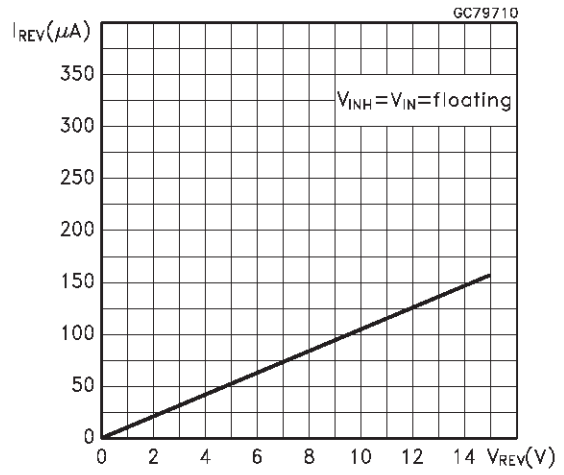

Output Voltage vs Inhibit Voltage

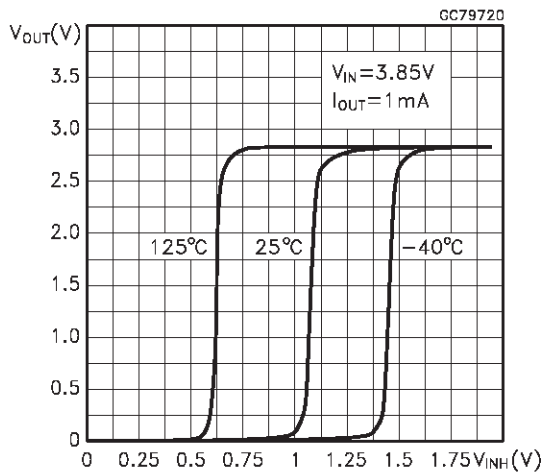

Inhibit Current vs Temperature

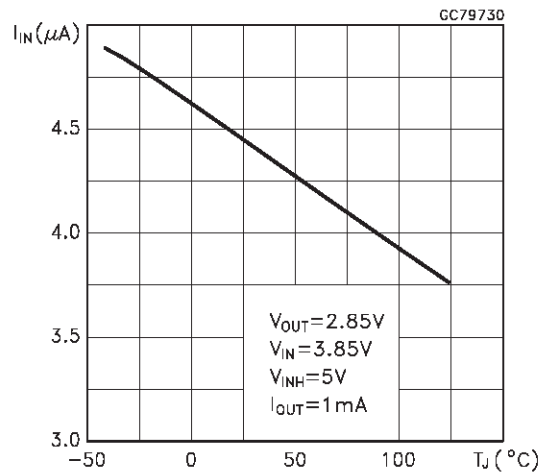

Supply Voltage Rejection at  $V_{OUT} = 2.85V$

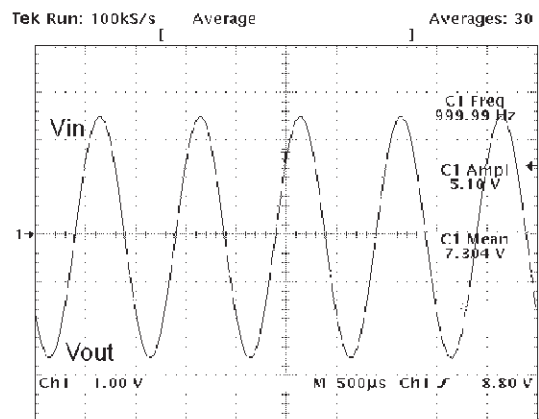

$V_{IN} = 7.35 \pm 2.5V$ ,  $I_{OUT} = 50mA$ ,  $f=1KHz$

Supply Voltage Rejection at  $V_{OUT} = 5V$

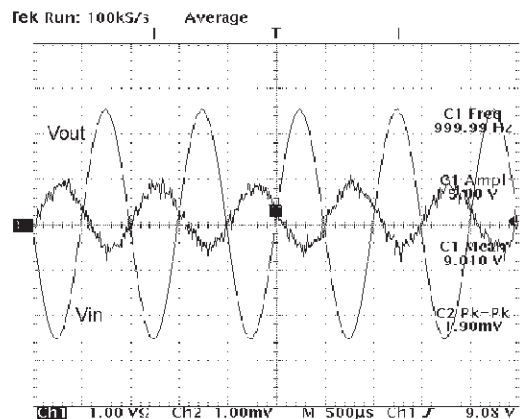

$V_{IN} = 9 \pm 2.5V$ ,  $I_{OUT} = 50mA$ ,  $f=1KHz$

TYPICAL PERFORMANCE CHARACTERISTICS (continued)

Line Transient Response

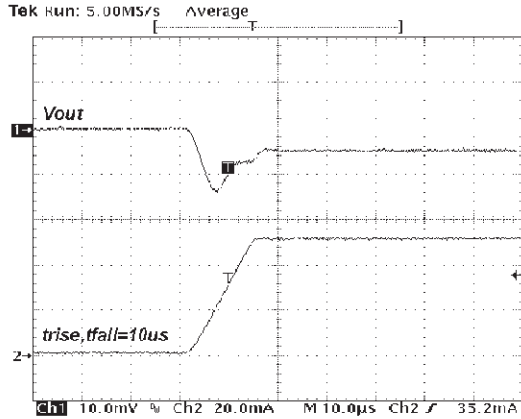

$V_{CC} = 5V$ ,  $I_{OUT} = 1$  to  $50mA$ ,  $C_{OUT} = 10\mu F$ ,  $C_{IN} = 150nF$   
( $ESR=1\Omega$  at  $1KHz$ )

Line Transient Response

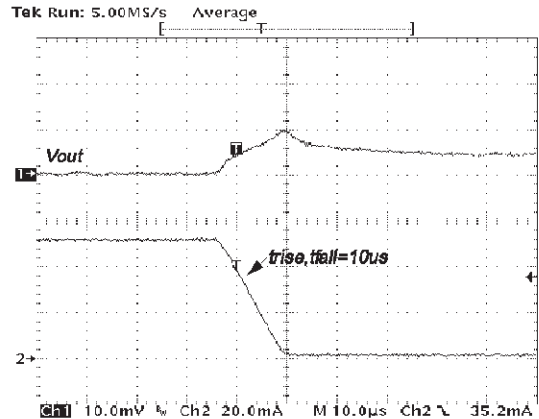

$V_{CC} = 5V$ ,  $I_{OUT} = 50$  to  $1mA$ ,  $C_{OUT} = 10\mu F$ ,  $C_{IN} = 150nF$   
( $ESR=1\Omega$  at  $1KHz$ )

Line Transient Response

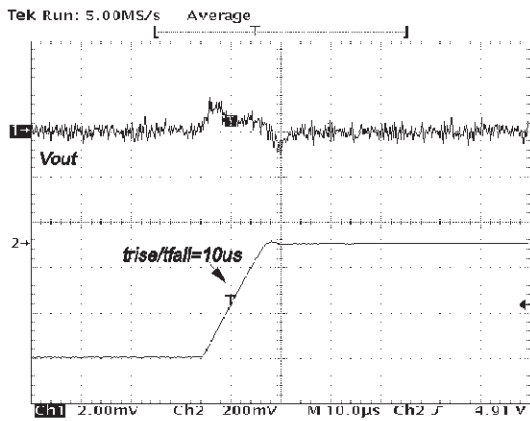

$V_{CC} = 4.75$  to  $5.25V$ ,  $I_{OUT} = 0.05A$ ,  $C_{OUT} = 10\mu F$ ,  $C_{IN} = 150nF$   
( $ESR=1\Omega$  at  $1KHz$ )

Line Transient Response

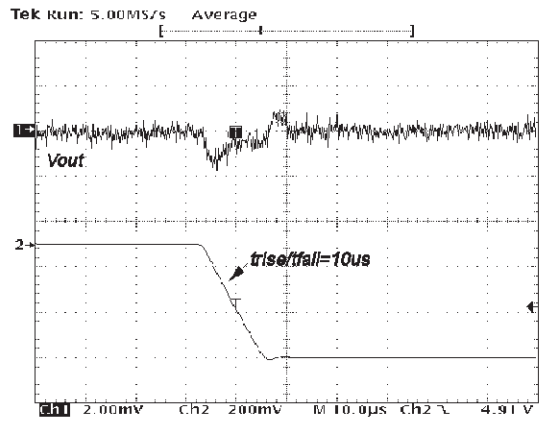

$V_{CC} = 5.25$  to  $6.25V$ ,  $I_{OUT} = 0.05A$ ,  $C_{OUT} = 10\mu F$ ,  $C_{IN} = 150nF$   
( $ESR=1\Omega$  at  $1KHz$ )

Supply Voltage Rejection

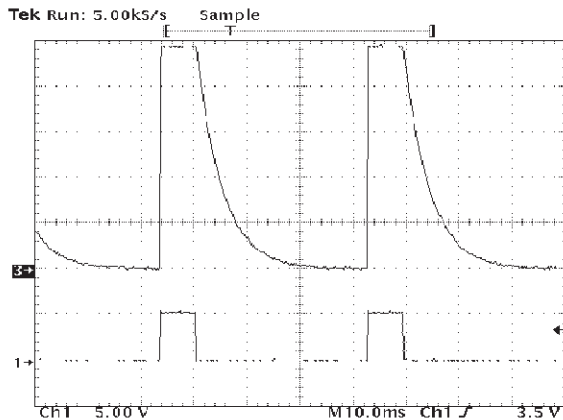

$V_{OUT} = 5V$ ,  $V_{IN} = 6V$ ,  $V_{INH} = 0$  to  $5V$ ,  $C_{IN} = C_{OUT} = 1\mu F$  (Tant.)



## SOT-89 MECHANICAL DATA

DIM.	mm			mils		
	MIN.	TYP.	MAX.	MIN.	TYP.	MAX.
A	1.4		1.6	55.1		63.0
B	0.44		0.56	17.3		22.0
B1	0.36		0.48	14.2		18.9
C	0.35		0.44	13.8		17.3
C1	0.35		0.44	13.8		17.3
D	4.4		4.6	173.2		181.1
D1	1.62		1.83	63.8		72.0
E	2.29		2.6	90.2		102.4
e	1.42		1.57	55.9		61.8
e1	2.92		3.07	115.0		120.9
H	3.94		4.25	155.1		167.3
L	0.89		1.2	35.0		47.2

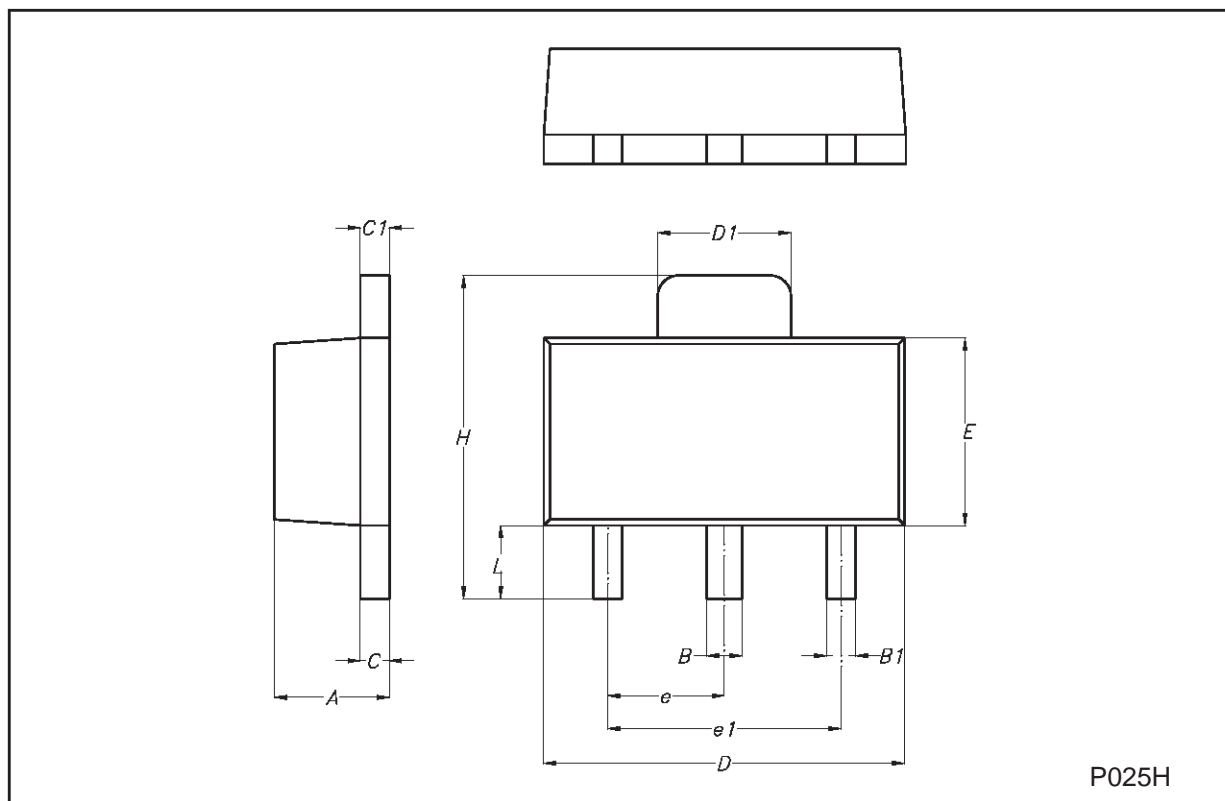

## SOT23-5L MECHANICAL DATA

DIM.	mm			mils		
	MIN.	TYP.	MAX.	MIN.	TYP.	MAX.
A	0.90		1.45	35.4		57.1
A1	0.00		0.15	0.0		5.9
A2	0.90		1.30	35.4		51.2
b	0.35		0.50	13.7		19.7
C	0.09		0.20	3.5		7.8
D	2.80		3.00	110.2		118.1
E	2.60		3.00	102.3		118.1
E1	1.50		1.75	59.0		68.8
L	0.35		0.55	13.7		21.6
e		0.95			37.4	
e1		1.9			74.8	

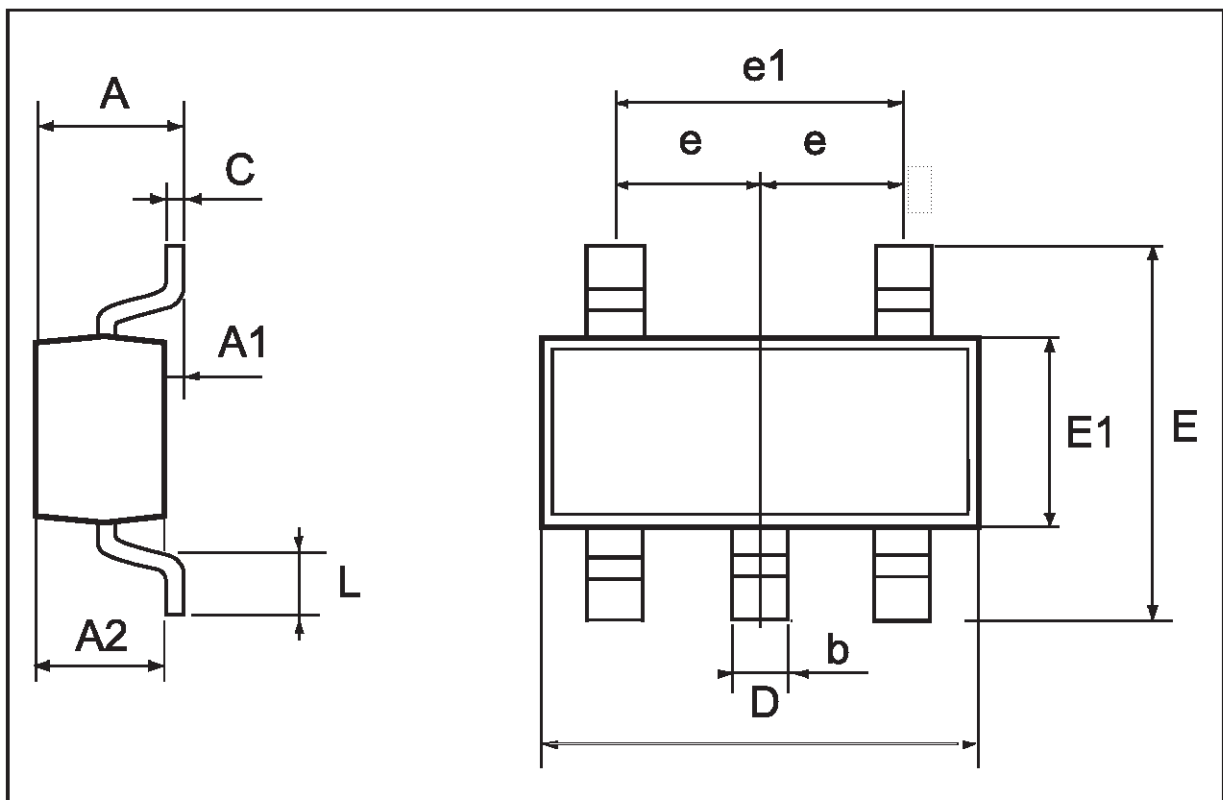

Information furnished is believed to be accurate and reliable. However, STMicroelectronics assumes no responsibility for the consequences of use of such information nor for any infringement of patents or other rights of third parties which may result from its use. No license is granted by implication or otherwise under any patent or patent rights of STMicroelectronics. Specification mentioned in this publication are subject to change without notice. This publication supersedes and replaces all information previously supplied. STMicroelectronics products are not authorized for use as critical components in life support devices or systems without express written approval of STMicroelectronics.

The ST logo is a registered trademark of STMicroelectronics

© 2000 STMicroelectronics – Printed in Italy – All Rights Reserved

STMicroelectronics GROUP OF COMPANIES

Australia - Brazil - China - Finland - France - Germany - Hong Kong - India - Italy - Japan - Malaysia - Malta - Morocco  
Singapore - Spain - Sweden - Switzerland - United Kingdom - U.S.A.

<http://www.st.com>