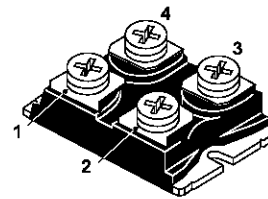
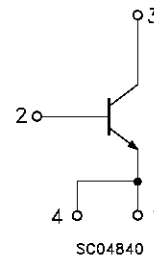

NPN TRANSISTOR POWER MODULE

- EASY TO DRIVE TECHNOLOGY (ETD)
- HIGH CURRENT POWER BIPOLAR MODULE
- VERY LOW R_{th} JUNCTION CASE
- SPECIFIED ACCIDENTAL OVERLOAD AREAS
- ISOLATED CASE (2500V RMS)
- EASY TO MOUNT
- LOW INTERNAL PARASITIC INDUCTANCE

APPLICATIONS:

- MOTOR CONTROL
- SMPS & UPS
- WELDING EQUIPMENT

ISOTOP
INTERNAL SCHEMATIC DIAGRAM

ABSOLUTE MAXIMUM RATINGS

Symbol	Parameter	Value	Unit
V_{CEV}	Collector-Emitter Voltage ($V_{BE} = -5\text{ V}$)	1000	V
$V_{CEO(sus)}$	Collector-Emitter Voltage ($I_B = 0$)	450	V
V_{EBO}	Emitter-Base Voltage ($I_C = 0$)	7	V
I_C	Collector Current	80	A
I_{CM}	Collector Peak Current ($t_p = 10\text{ ms}$)	160	A
I_B	Base Current	18	A
I_{BM}	Base Peak Current ($t_p = 10\text{ ms}$)	27	A
P_{tot}	Total Dissipation at $T_c = 25\text{ }^\circ\text{C}$	270	W
T_{stg}	Storage Temperature	-65 to 150	$^\circ\text{C}$
T_j	Max Operation Junction Temperature	150	$^\circ\text{C}$
V_{ISO}	Insulation Withstand Voltage (AC-RMS)	2500	V

BUF460AV

THERMAL DATA

$R_{thj-case}$	Thermal Resistance Junction-case	Max	0.41	$^{\circ}C/W$
R_{thc-h}	Thermal Resistance Case-heatsink With Conductive Grease Applied	Max	0.05	$^{\circ}C/W$

ELECTRICAL CHARACTERISTICS ($T_{case} = 25^{\circ}C$ unless otherwise specified)

Symbol	Parameter	Test Conditions	Min.	Typ.	Max.	Unit
I_{CER}	Collector Cut-off Current ($R_{BE} = 5 \Omega$)	$V_{CE} = V_{CEV}$ $V_{CE} = V_{CEV} \quad T_j = 100^{\circ}C$			0.2 2	mA mA
I_{CEV}	Collector Cut-off Current ($V_{BE} = -1.5V$)	$V_{CE} = V_{CEV}$ $V_{CE} = V_{CEV} \quad T_j = 100^{\circ}C$			0.2 2	mA mA
I_{EBO}	Emitter Cut-off Current ($I_C = 0$)	$V_{EB} = 5 V$			1	mA
$V_{CEO(SUS)}^*$	Collector-Emitter Sustaining Voltage	$I_C = 0.2 A \quad L = 25 mH$ $V_{clamp} = 450 V$	450			V
h_{FE}^*	DC Current Gain	$I_C = 60 A \quad V_{CE} = 5 V$		15		
$V_{CE(sat)}^*$	Collector-Emitter Saturation Voltage	$I_C = 30 A \quad I_B = 3 A$ $I_C = 30 A \quad I_B = 3 A \quad T_j = 100^{\circ}C$ $I_C = 60 A \quad I_B = 12 A$ $I_C = 60 A \quad I_B = 12 A \quad T_j = 100^{\circ}C$		0.35 0.5	2 2	V V V V
$V_{BE(sat)}^*$	Base-Emitter Saturation Voltage	$I_C = 60 A \quad I_B = 12 A$ $I_C = 60 A \quad I_B = 12 A \quad T_j = 100^{\circ}C$		1.1	1.5	V V
di_C/dt	Rate of Rise of On-state Collector	$V_{CC} = 300 V \quad R_C = 0 \quad t_p = 3 \mu s$ $I_{B1} = 18 A \quad T_j = 100^{\circ}C$	150			A/ μs
$V_{CE(3 \mu s)}$	Collector-Emitter Dynamic Voltage	$V_{CC} = 300 V \quad R_C = 30 \Omega$ $I_{B1} = 18 A \quad T_j = 100^{\circ}C$		4	6	V
$V_{CE(5 \mu s)}$	Collector-Emitter Dynamic Voltage	$V_{CC} = 300 V \quad R_C = 30 \Omega$ $I_{B1} = 18 A \quad T_j = 100^{\circ}C$		2	3	V
t_s	Storage Time	$I_C = 30 A \quad V_{CC} = 50 V$		4.5	5	μs
t_f	Fall Time	$V_{BB} = -5 V \quad R_{BB} = 0.2 \Omega$		0.1	0.2	μs
t_c	Cross-over Time	$V_{clamp} = 400 V \quad I_{B1} = 3 A$ $L = 25 \mu H \quad T_j = 100^{\circ}C$		0.3	5	μs
V_{CEW}	Maximum Collector Emitter Voltage Without Snubber	$I_{Cwoff} = 80 A \quad I_{B1} = 16 A$ $V_{BB} = -5 V \quad V_{CC} = 50 V$ $L = 80 \mu H \quad R_{BB} = 0.2 \Omega$ $T_j = 125^{\circ}C$	400			V

* Pulsed: Pulse duration = 300 μs , duty cycle 1.5 %

Safe Operating Areas

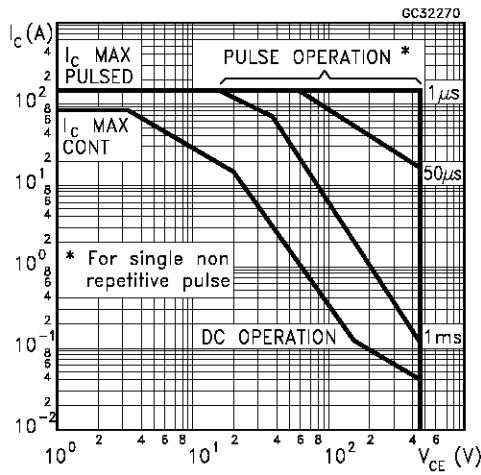

Thermal Impedance

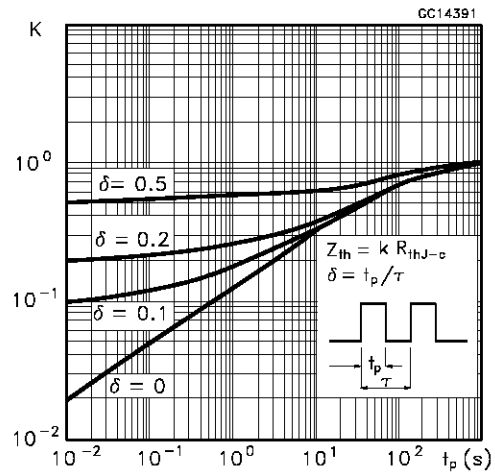

Derating Curve

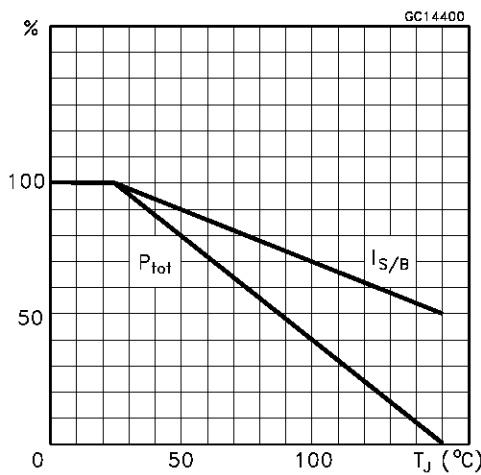

Collector-Emitter Voltage Versus Base-Emitter Resistance

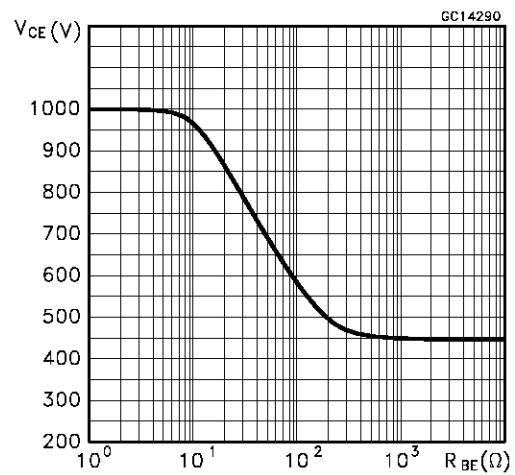

Collector-Emitter Saturation Voltage

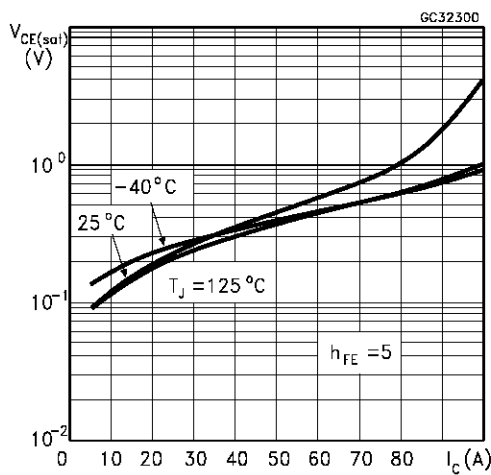

Base-Emitter Saturation Voltage

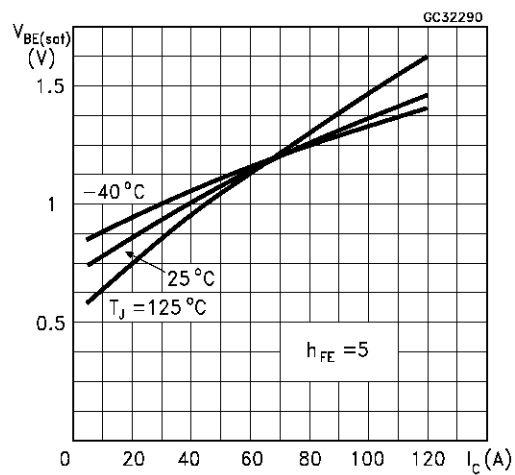

Reverse Biased SOA

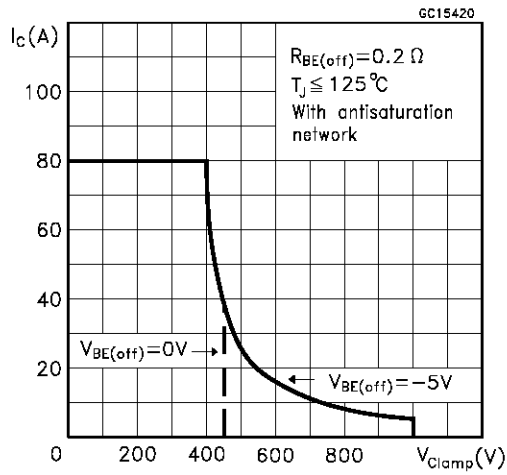

Forward Biased SOA

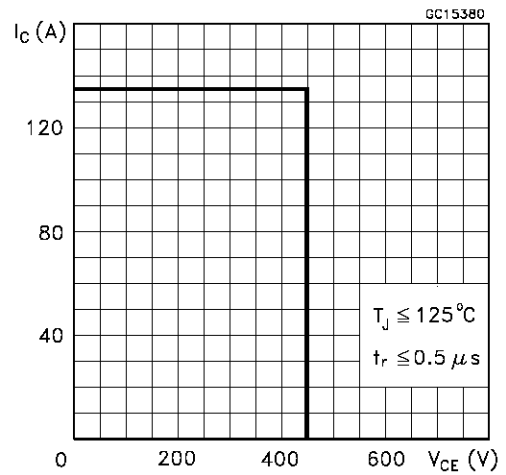

Reverse Biased SOA

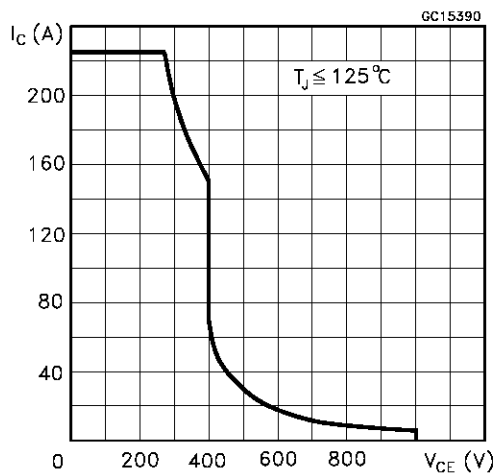

Forward Biased SOA

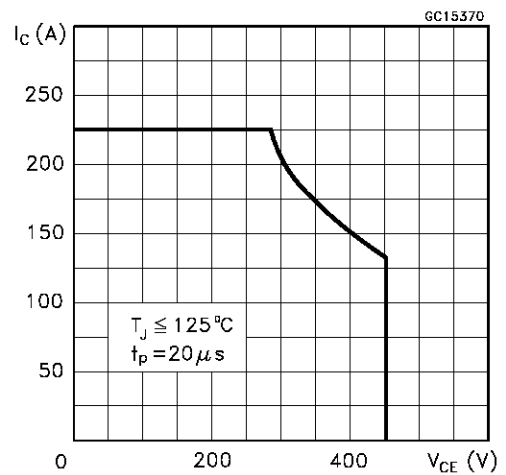

Switching Time Inductive Load

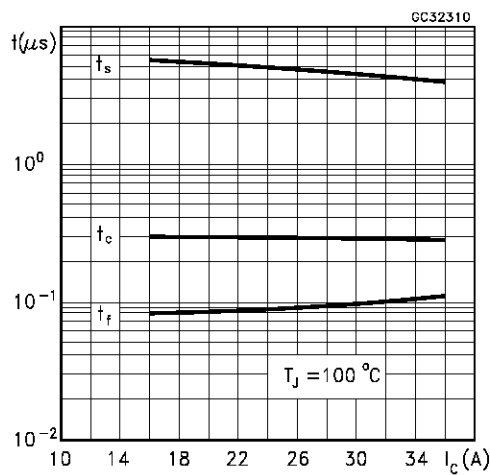

Switching Time Inductive Load Versus Temperature

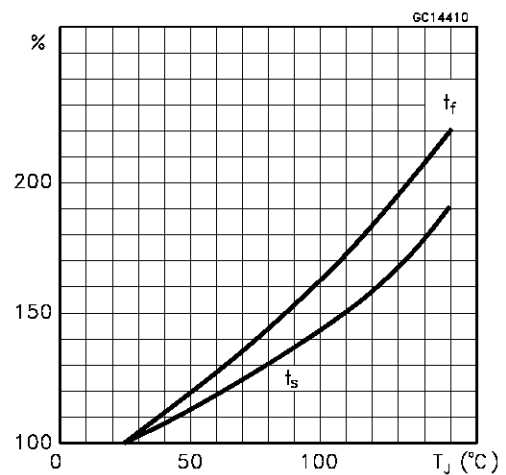

DC Current Gain

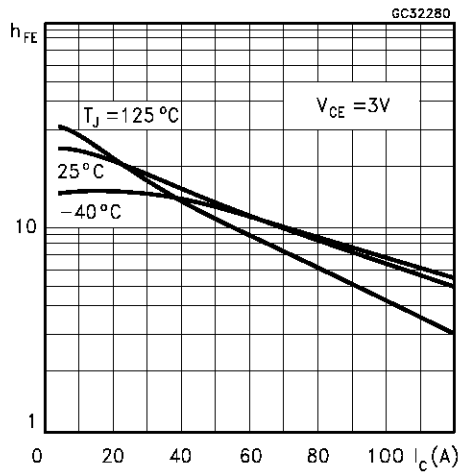

Turn-off Switching Test Circuit

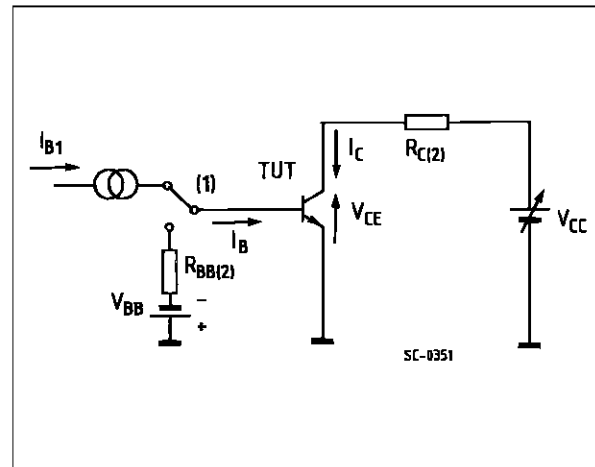

- 1) Fast electronic switch
- 2) Non-inductive Resistor

Turn-on Switching Waveforms.

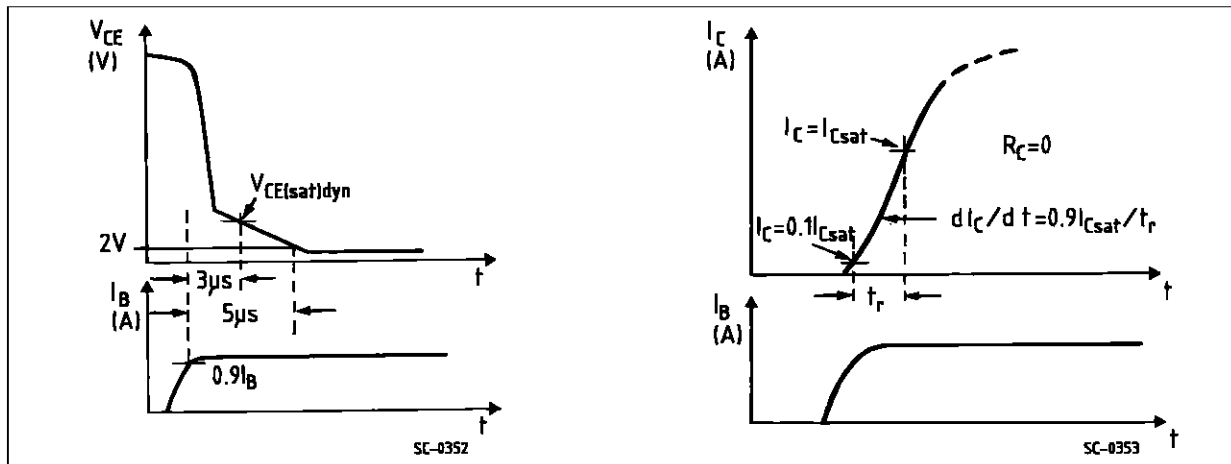

Turn-off Switching Test Circuit

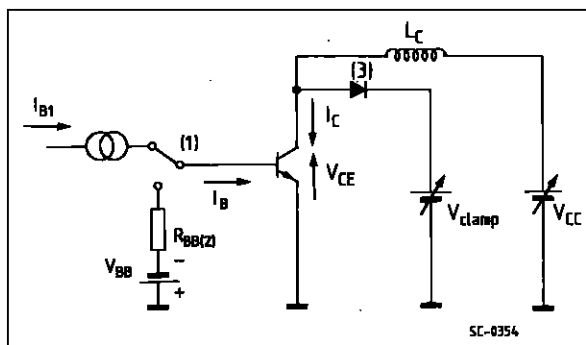

- 1) Fast electronic switch
- 2) Non-inductive Resistor
- 3) Fast recovery rectifier

Turn-off Switching Waveforms.

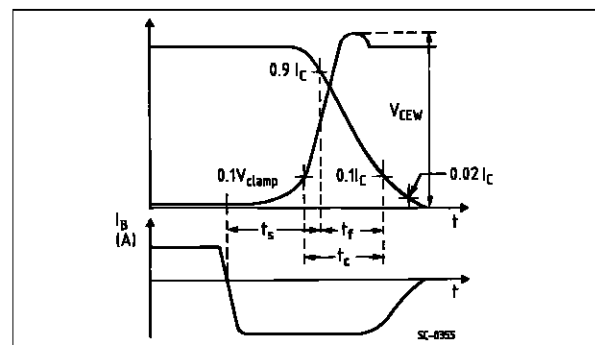

ISOTOP MECHANICAL DATA

DIM.	mm			inch		
	MIN.	TYP.	MAX.	MIN.	TYP.	MAX.
A	11.8		12.2	0.466		0.480
B	8.9		9.1	0.350		0.358
C	1.95		2.05	0.076		0.080
D	0.75		0.85	0.029		0.033
E	12.6		12.8	0.496		0.503
F	25.15		25.5	0.990		1.003
G	31.5		31.7	1.240		1.248
H	4			0.157		
J	4.1		4.3	0.161		0.169
K	14.9		15.1	0.586		0.594
L	30.1		30.3	1.185		1.193
M	37.8		38.2	1.488		1.503
N	4			0.157		
O	7.8		8.2	0.307		0.322

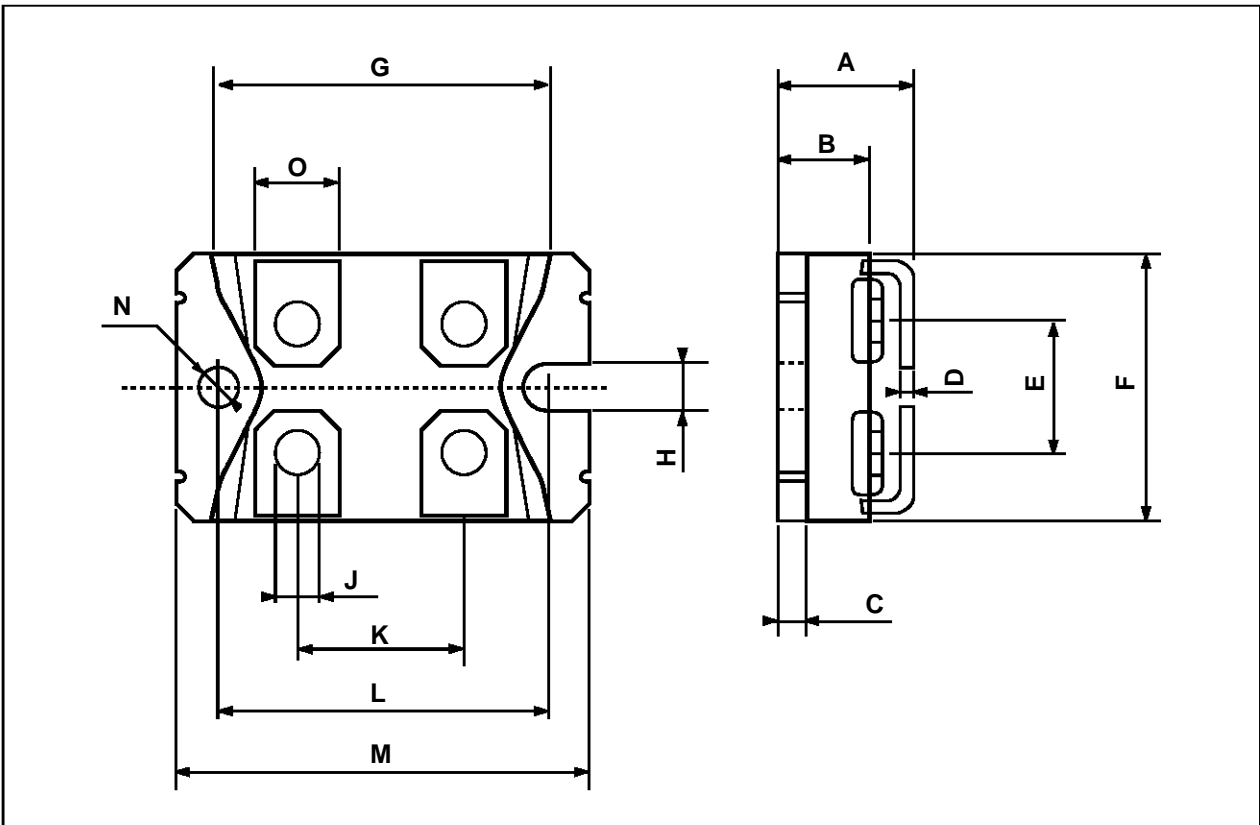

Information furnished is believed to be accurate and reliable. However, SGS-THOMSON Microelectronics assumes no responsibility for the consequences of use of such information nor for any infringement of patents or other rights of third parties which may result from its use. No license is granted by implication or otherwise under any patent or patent rights of SGS-THOMSON Microelectronics. Specifications mentioned in this publication are subject to change without notice. This publication supersedes and replaces all information previously supplied. SGS-THOMSON Microelectronics products are not authorized for use as critical components in life support devices or systems without express written approval of SGS-THOMSON Microelectronics.

© 1997 SGS-THOMSON Microelectronics - Printed in Italy - All Rights Reserved

SGS-THOMSON Microelectronics GROUP OF COMPANIES
Australia - Brazil - Canada - China - France - Germany - Hong Kong - Italy - Japan - Korea - Malaysia - Malta - Morocco - The Netherlands -
Singapore - Spain - Sweden - Switzerland - Taiwan - Thailand - United Kingdom - U.S.A

...