

HIGH-SPEED SATURATED SWITCHES

DESCRIPTION

The 2N2894, and 2N3209 are silicon planar epitaxial PNP transistors in Jedec TO-18 metal case, intended for high speed, low saturation switching applications up to 100 mA.

 Products approved to CECC 50004-022/023 available on request.

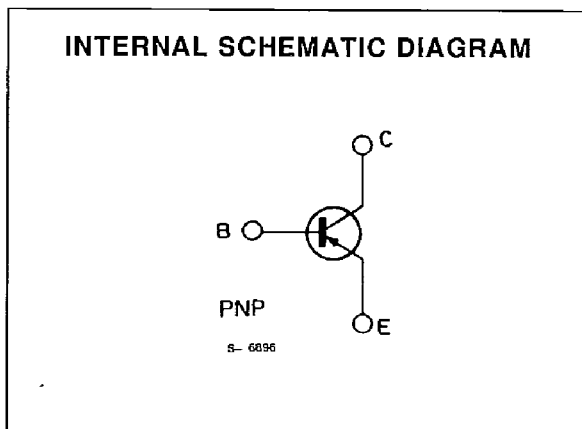
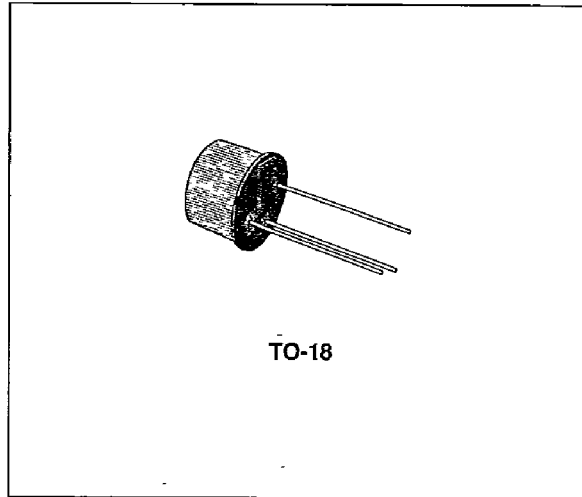

ABSOLUTE MAXIMUM RATINGS

Symbol	Parameter	Value		Unit
		2N2894	2N3209	
V_{CB0}	Collector-base Voltage ($I_E = 0$)	- 12	- 20	V
V_{CES}	Collector-emitter Voltage ($V_{BE} = 0$)	- 12	- 20	V
V_{CEO}	Collector-emitter Voltage ($I_B = 0$)	- 12	- 20	V
V_{EBO}	Emitter-base Voltage ($I_C = 0$)	- 4		V
I_C	Collector Current	- 200		mA
P_{tot}	Total Power Dissipation at $T_{amb} \leq 25\text{ }^\circ\text{C}$ at $T_{case} \leq 25\text{ }^\circ\text{C}$	0.36		W
		1.2		W
T_{stg}, T_j	Storage and Junction Temperature	- 65 to 200		$^\circ\text{C}$

THERMAL DATA

$R_{th\ j-case}$	Thermal Resistance Junction-case	Max	146	°C/W
$R_{th\ j-amb}$	Thermal Resistance Junction-ambient	Max	486	°C/W

ELECTRICAL CHARACTERISTICS ($T_{amb} = 25\text{ °C}$ unless otherwise specified)

Symbol	Parameter	Test Conditions	Min.	Typ.	Max.	Unit
I_{CBO}	Collector Cutoff Current ($I_E = 0$) (for 2N2894 only)	$V_{CB} = -6\text{ V}$ $T_{amb} = 125\text{ °C}$			-10	μA
I_{CES}	Collector Cutoff Current ($V_{BE} = 0$)	for 2N2894 $V_{CE} = -6\text{ V}$ for 2N3209 $V_{CE} = -10\text{ V}$ $V_{CE} = -10\text{ V}$ $T_{amb} = 125\text{ °C}$			-80 -80 -10	nA nA μA
$V_{(BR)CBO}$	Collector-base Breakdown Voltage ($I_E = 0$)	$I_C = -10\text{ }\mu\text{A}$ for 2N2894 for 2N3209	-12 -20			V V
$V_{(BR)CES}$	Collector-emitter Breakdown Voltage ($V_{BE} = 0$)	$I_C = -10\text{ }\mu\text{A}$ for 2N2894 for 2N3209	-12 -20			V V
$V_{(BR)CEO}^*$	Collector-emitter Breakdown Voltage ($I_B = 0$)	$I_C = -10\text{ mA}$ for 2N2894 for 2N3209	-12 -20			V V
$V_{(BR)EBO}$	Emitter-base Breakdown Voltage ($I_C = 0$)	$I_E = -100\text{ }\mu\text{A}$	-4			V
$V_{CE(sat)}^*$	Collector-emitter Saturation Voltage	for 2N2894 $I_C = -10\text{ mA}$ $I_B = -1\text{ mA}$ $I_C = -30\text{ mA}$ $I_B = -3\text{ mA}$ $I_C = -100\text{ mA}$ $I_B = -10\text{ mA}$ for 2N3209 $I_C = -10\text{ mA}$ $I_B = -1\text{ mA}$ $I_C = -30\text{ mA}$ $I_B = -3\text{ mA}$ $I_C = -100\text{ mA}$ $I_B = -10\text{ mA}$			-0.15 -0.2 -0.5 -0.15 -0.2 -0.6	V V V V V V
$V_{BE(sat)}^*$	Base-emitter Saturation Voltage	$I_C = -10\text{ mA}$ $I_B = -1\text{ mA}$ $I_C = -30\text{ mA}$ $I_B = -3\text{ mA}$ $I_C = -100\text{ mA}$ $I_B = -10\text{ mA}$	-0.78 -0.85		-0.98 -1.2 -1.7	V V V
h_{FE}^*	DC Current Gain	$I_C = -10\text{ mA}$ $V_{CE} = -0.3\text{ V}$ for 2N2894 for 2N3209 $I_C = -30\text{ mA}$ $V_{CE} = -0.5\text{ V}$ for 2N2894 for 2N3209 $I_C = -100\text{ mA}$ $V_{CE} = -1\text{ V}$ for 2N2894 for 2N3209 $I_C = -30\text{ mA}$ $V_{CE} = -0.5\text{ V}$ $T_{amb} = -55\text{ °C}$ for 2N2894 for 2N3209	30 25 40 30 25 15 17 12		150 120	
f_T	Transition Frequency	$I_C = -30\text{ mA}$ $V_{CE} = -10\text{ V}$ $f = 100\text{ MHz}$	400			MHz
C_{EBO}	Emitter-base Capacitance	$I_C = 0$ $V_{EB} = -0.5\text{ V}$ $f = 1\text{ MHz}$			6	pF

* Pulsed : pulse duration = 300 μs , duty cycle = 1 %.

SGS-THOMSON

ELECTRICAL CHARACTERISTICS (continued)

T-37-09

Symbol	Parameter	Test Conditions	Min.	Typ.	Max.	Unit
C_{CB0}	Collector-base Capacitance	$I_E = 0$ $f = 1 \text{ MHz}$ for 2N2894 $V_{CB} = -5 \text{ V}$ for 2N3209			6 5	pF pF
t_{on}^{**}	Turn-on Time	$I_C = -30 \text{ mA}$ $V_{CC} = -2 \text{ V}$ $I_{B1} = -1.5 \text{ mA}$			60	ns
t_{off}^{**}	Turn-off Time	$I_C = -30 \text{ mA}$ $V_{CC} = -2 \text{ V}$ $I_{B1} = -I_{B2} = -1.5 \text{ mA}$			90	ns

** See test circuit.

Collector-emitter Saturation Voltage.

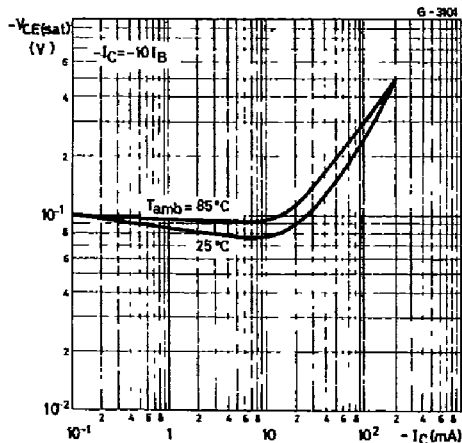

Emitter-base and Collector-base capacitance.

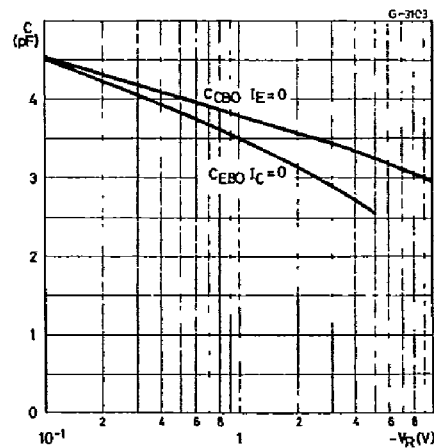

Contours of Constant Transition Frequency.

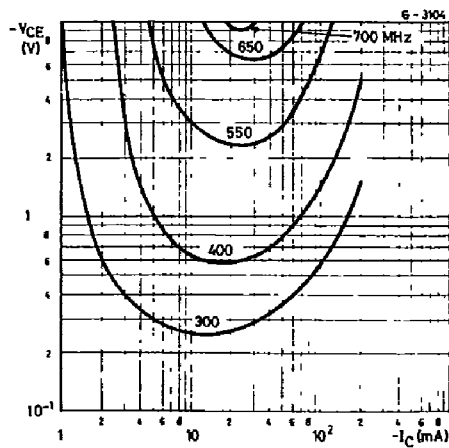

Switching Characteristics.

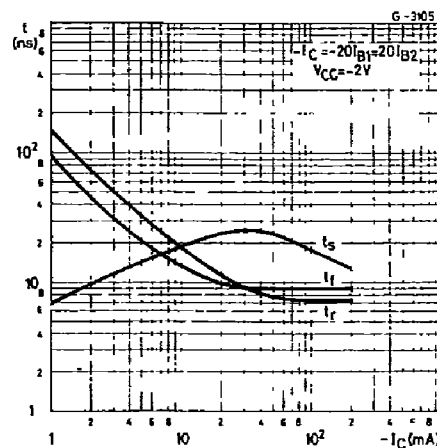

TEST CIRCUIT FOR t_{on} , t_{off} .

