

PNP SILICON POWER TRANSISTOR

- SURFACE-MOUNTING D²PAK (TO-263) POWER PACKAGE IN TAPE & REEL (SUFFIX "T4")
- ELECTRICALLY SIMILAR TO TIP32B

APPLICATION

- LINEAR AND SWITCHING INDUSTRIAL EQUIPMENT

DESCRIPTION

The MJB32B is manufactured using Epitaxial-base Technology for use in medium power linear and switching applications.

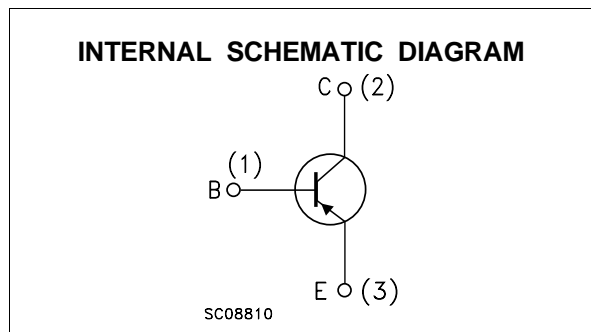
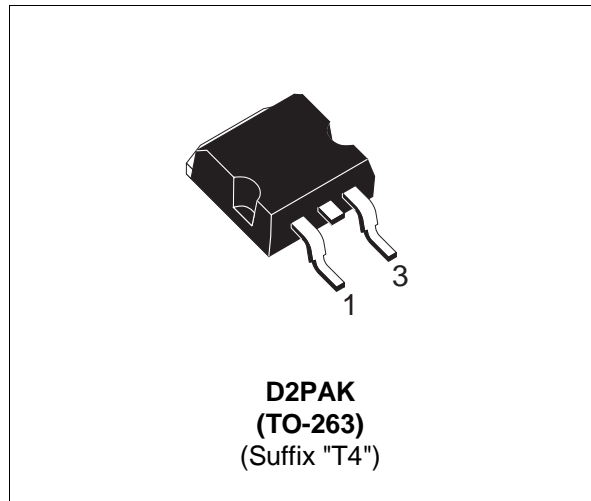

ABSOLUTE MAXIMUM RATINGS

Symbol	Parameter	Value	Unit
V_{CBO}	Collector-Base Voltage ($I_E = 0$)	-80	V
V_{CEO}	Collector-Emitter Voltage ($I_B = 0$)	-80	V
V_{EBO}	Emitter-Base Voltage ($I_C = 0$)	-5	V
I_C	Collector Current	-3	A
I_{CM}	Collector Peak Current	-5	A
I_B	Base Current	-1	A
P_{tot}	Total Dissipation at $T_{case} \leq 25\text{ }^\circ\text{C}$ $T_{amb} \leq 25\text{ }^\circ\text{C}$	40	W
		2	W
T_{stg}	Storage Temperature	-65 to 150	$^\circ\text{C}$
T_j	Max. Operating Junction Temperature	150	$^\circ\text{C}$

MJB32B

THERMAL DATA

R _{thj-case}	Thermal Resistance Junction-case	Max	3.12	°C/W
R _{thj-amb}	Thermal Resistance Junction-ambient	Max	62.5	°C/W

ELECTRICAL CHARACTERISTICS (T_{case} = 25 °C unless otherwise specified)

Symbol	Parameter	Test Conditions	Min.	Typ.	Max.	Unit
I _{CEO}	Collector Cut-off Current (I _B = 0)	V _{CE} = -60 V			-50	μA
I _{CES}	Collector Cut-off Current (V _{BE} = 0)	V _{CE} = -80 V			-20	μA
I _{EBO}	Emitter Cut-off Current (I _C = 0)	V _{EB} = -5 V			-0.1	mA
V _{CEO(sus)*}	Collector-Emitter Sustaining Voltage (I _B = 0)	I _C = -30 mA	-80			V
V _{CE(sat)*}	Collector-Emitter Saturation Voltage	I _C = -3 A I _B = -375 mA			-1.2	V
V _{BE*}	Base-Emitter Voltage	I _C = -3 A V _{CE} = -4 V			-1.8	V
h _{FE*}	DC Current Gain	I _C = -1 A V _{CE} = -4 V I _C = -3 A V _{CE} = -4 V	25 10		50	
h _{fe}	Small Signal Current Gain	I _C = -0.5 A V _{CE} = -10 V f = 1 KHZ I _C = -0.5 A V _{CE} = -10 V f = 1 MHZ	20 3			

* Pulsed : pulse duration = 300 μs, duty cycle ≤ 2%

Safe Operating Area

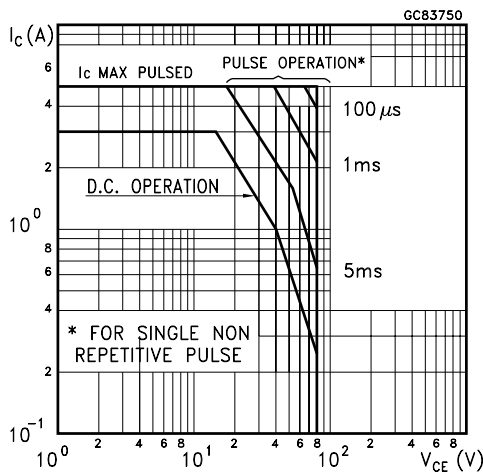

Derating Curves

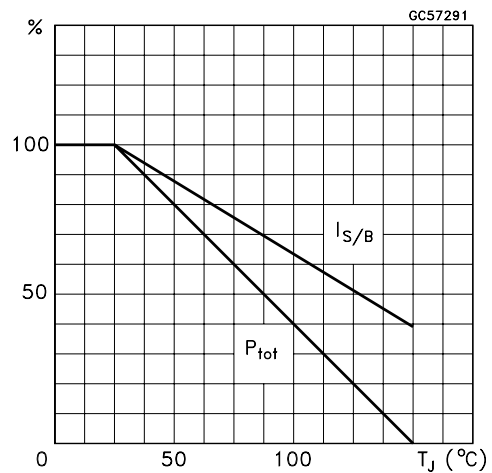

DC Current Gain

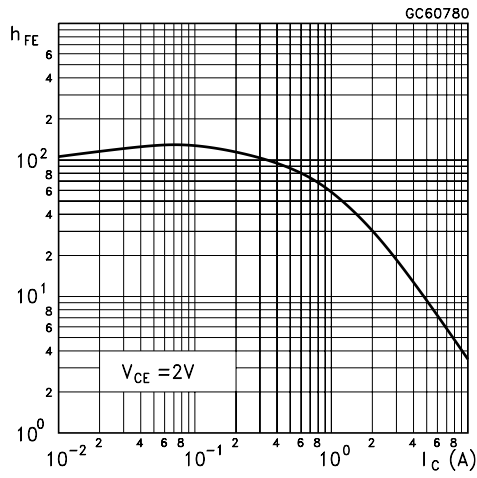

Collector-Emitter Saturation Voltage

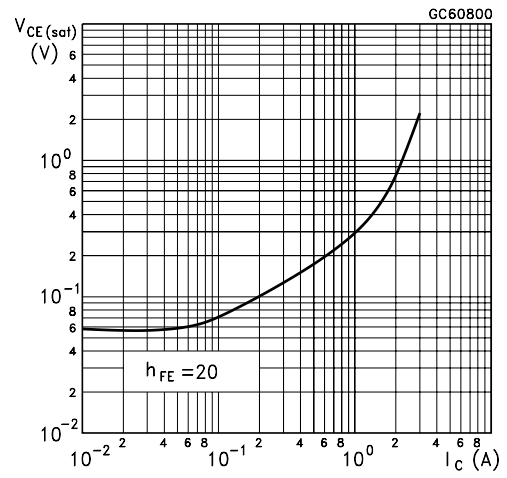

Collector-Base Capacitance

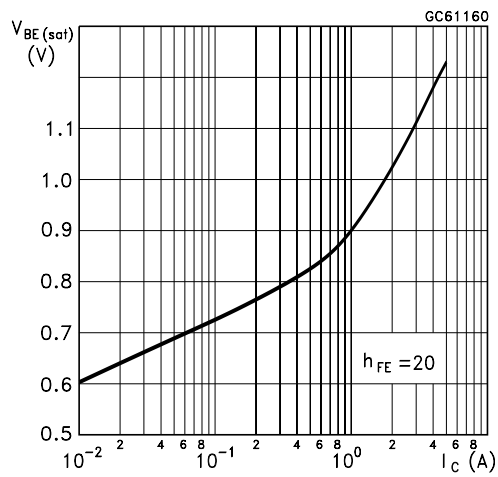

TO-263 (D²PAK) MECHANICAL DATA

DIM.	mm			inch		
	MIN.	TYP.	MAX.	MIN.	TYP.	MAX.
A	4.40		4.60	0.173		0.181
A1	2.49		2.69	0.098		0.106
A2	0.03		0.23	0.001		0.009
B	0.70		0.93	0.027		0.036
B2	1.14		1.70	0.044		0.067
C	0.45		0.60	0.017		0.023
C2	1.23		1.36	0.048		0.053
D	8.95		9.35	0.352		0.368
D1		8.00			0.315	
E	10.00		10.40	0.393		0.409
E1		8.50			0.334	
G	4.88		5.28	0.192		0.208
L	15.00		15.85	0.590		0.624
L2	1.27		1.4	0.050		0.055
L3	1.40		1.75	0.055		0.068
M	2.40		3.2	0.094		0.126
R		0.40			0.016	
V2	0°		8°	0°		8°

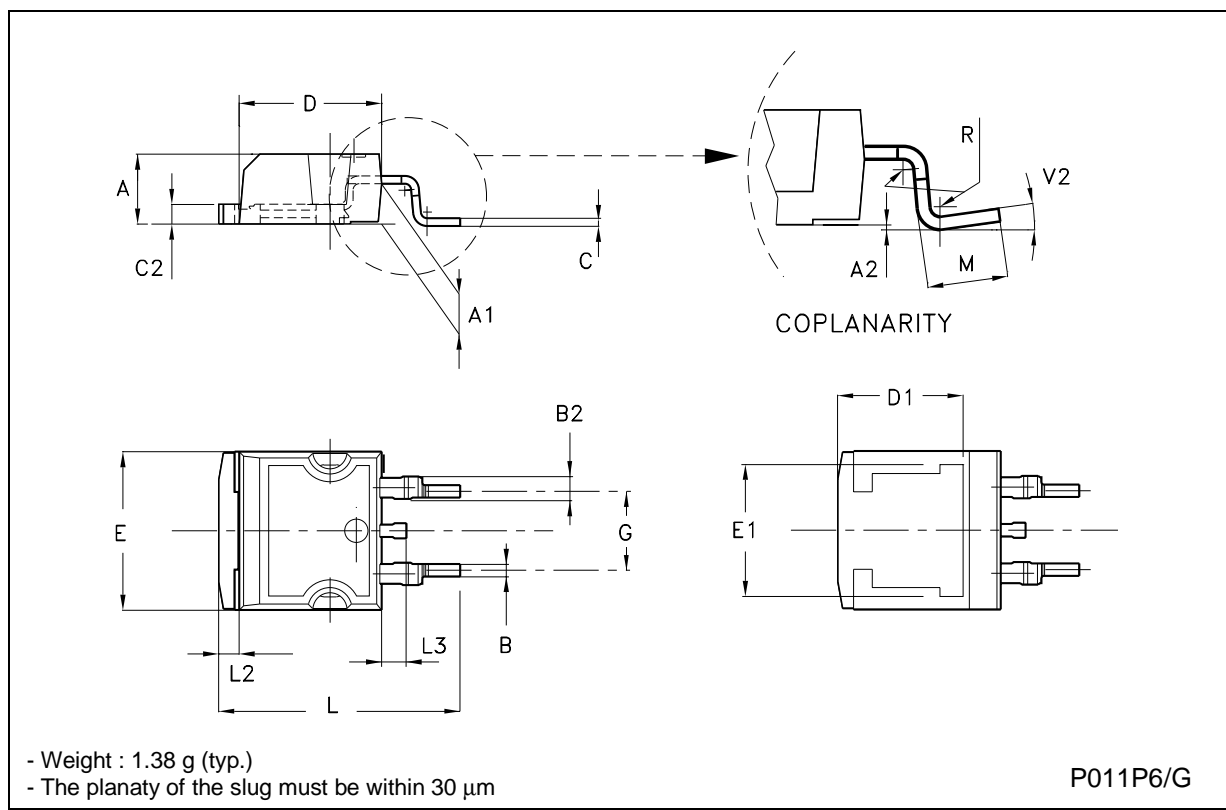

Information furnished is believed to be accurate and reliable. However, STMicroelectronics assumes no responsibility for the consequences of use of such information nor for any infringement of patents or other rights of third parties which may result from its use. No license is granted by implication or otherwise under any patent or patent rights of STMicroelectronics. Specification mentioned in this publication are subject to change without notice. This publication supersedes and replaces all information previously supplied. STMicroelectronics products are not authorized for use as critical components in life support devices or systems without express written approval of STMicroelectronics.

The ST logo is a trademark of STMicroelectronics

© 2001 STMicroelectronics – Printed in Italy – All Rights Reserved

STMicroelectronics GROUP OF COMPANIES

Australia - Brazil - China - Finland - France - Germany - Hong Kong - India - Italy - Japan - Malaysia - Malta - Morocco -
Singapore - Spain - Sweden - Switzerland - United Kingdom - U.S.A.

<http://www.st.com>