



STB160NF03L

N-CHANNEL 30V - 0.0021Ω - 160A D2PAK STripFET™ POWER MOSFET

TYPE	V _{DSS}	R _{DS(on)}	I _D
STB160NF03L	30 V	< 0.0030 Ω	160 A

- TYPICAL R_{DS(on)} = 0.0021Ω
- LOW THRESHOLD DRIVE
- ULTRA LOW ON-RESISTANCE
- VERY LOW GATE CHARGE
- 100% AVALANCHE TESTED

DESCRIPTION

This Power MOSFET is the latest development of STMicroelectronics unique "Single Feature Size™" strip-based process. The resulting transistor shows extremely high packing density with ultra low on-resistance, superior switching characteristics and less critical alignment steps therefore a remarkable manufacturing reproducibility. This device is particularly suitable for high current, low voltage switching application where efficiency is crucial.

APPLICATIONS

- BUCK CONVERTERS IN HIGH PERFORMANCE TELECOM AND VRMs
- DC-DC CONVERTERS

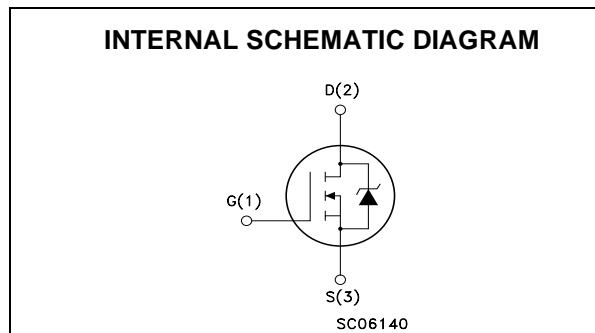
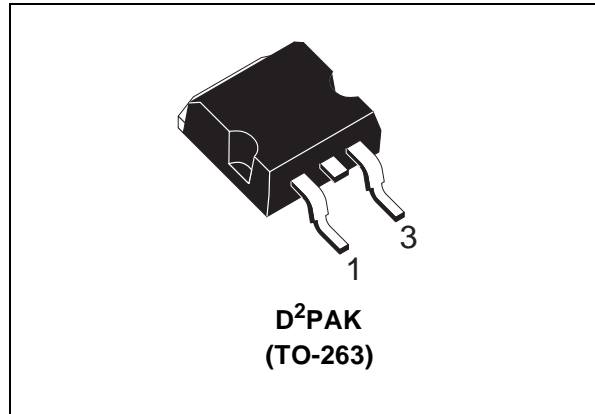

ABSOLUTE MAXIMUM RATINGS

Symbol	Parameter	Value	Unit
V _{DS}	Drain-source Voltage (V _{GS} = 0)	30	V
V _{DGR}	Drain-gate Voltage (R _{GS} = 20 kΩ)	30	V
V _{GS}	Gate- source Voltage	±15	V
I _{D(1)}	Drain Current (continuous) at T _C = 25°C	160	A
I _D	Drain Current (continuous) at T _C = 100°C	113	A
I _{DM} (●)	Drain Current (pulsed)	640	A
P _{TOT}	Total Dissipation at T _C = 25°C	300	W
	Derating Factor	2	W/°C
E _{AS} (2)	Single Pulse Avalanche Energy	2	J
T _{stg}	Storage Temperature	-65 to 175	°C
T _j	Max. Operating Junction Temperature	175	°C

(●) Pulse width limited by safe operating area

(1) Limited by Package

(2) I_{SD} ≤ 100A, di/dt ≤ 300A/μs, V_{DD} ≤ V_{(BR)DSS}, T_j ≤ T_{JMAX}.

STB160NF03L

THERMAL DATA

Rthj-case	Thermal Resistance Junction-case Max	0.5	°C/W
Rthj-amb	Thermal Resistance Junction-ambient Max	62.5	°C/W
T _l	Maximum Lead Temperature For Soldering Purpose	300	°C

ELECTRICAL CHARACTERISTICS (TCASE = 25 °C UNLESS OTHERWISE SPECIFIED)

OFF

Symbol	Parameter	Test Conditions	Min.	Typ.	Max.	Unit
V _{(BR)DSS}	Drain-source Breakdown Voltage	I _D = 250 μA, V _{GS} = 0	30			V
I _{DSS}	Zero Gate Voltage Drain Current (V _{GS} = 0)	V _{DS} = Max Rating V _{DS} = Max Rating, T _C = 125 °C			1 10	μA μA
I _{GSS}	Gate-body Leakage Current (V _{DS} = 0)	V _{GS} = ±15V			±100	nA

ON (1)

Symbol	Parameter	Test Conditions	Min.	Typ.	Max.	Unit
V _{GS(th)}	Gate Threshold Voltage	V _{DS} = V _{GS} , I _D = 250μA	1			V
R _{DS(on)}	Static Drain-source On Resistance	V _{GS} = 10 V, I _D = 80 A V _{GS} = 5 V, I _D = 80 A		0.0021 0.0042	0.0030 0.0070	Ω Ω
I _{D(on)}	On State Drain Current	V _{DS} > I _{D(on)} × R _{DS(on)max} , V _{GS} = 10V	160			A

DYNAMIC

Symbol	Parameter	Test Conditions	Min.	Typ.	Max.	Unit
g _{fs} (1)	Forward Transconductance	V _{DS} > I _{D(on)} × R _{DS(on)max} , I _D = 80 A		210		S
C _{iss}	Input Capacitance	V _{DS} = 25V, f = 1 MHz, V _{GS} = 0		5600		pF
C _{OSS}	Output Capacitance			1720		pF
C _{rss}	Reverse Transfer Capacitance			310		pF

ELECTRICAL CHARACTERISTICS (CONTINUED)

SWITCHING ON

Symbol	Parameter	Test Conditions	Min.	Typ.	Max.	Unit
$t_{d(on)}$	Turn-on Delay Time	$V_{DD} = 15V, I_D = 80A$ $R_G = 4.7\Omega, V_{GS} = 10V$		28		ns
t_r	Rise Time	(see test circuit, Figure 3)		285		ns
Q_g	Total Gate Charge	$V_{DD} = 24V, I_D = 160A,$ $V_{GS} = 10V$		123		nC
Q_{gs}	Gate-Source Charge			21		nC
Q_{gd}	Gate-Drain Charge			40		nC

SWITCHING OFF

Symbol	Parameter	Test Conditions	Min.	Typ.	Max.	Unit
$t_{d(off)}$	Turn-off-Delay Time	$V_{DD} = 15V, I_D = 80A,$ $R_G = 4.7\Omega, V_{GS} = 10V$		110		ns
t_f	Fall Time	(see test circuit, Figure 5)		65		ns
$t_{d(off)}$	Off-voltage Rise Time	$V_{clamp} = 24V, I_D = 40A$		110		ns
t_f	Fall Time	$R_G = 4.7\Omega, V_{GS} = 10V$		35		ns
t_c	Cross-over Time			70		ns

SOURCE DRAIN DIODE

Symbol	Parameter	Test Conditions	Min.	Typ.	Max.	Unit
I_{SD}	Source-drain Current				160	A
$I_{SDM(1)}$	Source-drain Current (pulsed)				640	A
$V_{SD(2)}$	Forward On Voltage	$I_{SD} = 160A, V_{GS} = 0$			1.3	V
t_{rr}	Reverse Recovery Time	$I_{SD} = 80A, di/dt = 100A/\mu s,$ $V_{DD} = 15V, T_j = 25^\circ C$		80		ns
Q_{rr}	Reverse Recovery Charge	(see test circuit, Figure 5)		180		nC
I_{RRM}	Reverse Recovery Current			4.5		A

Note: 1. Pulsed: Pulse duration = 300 μs , duty cycle 1.5 %.
2. Pulse width limited by safe operating area.

Safe Operating Area

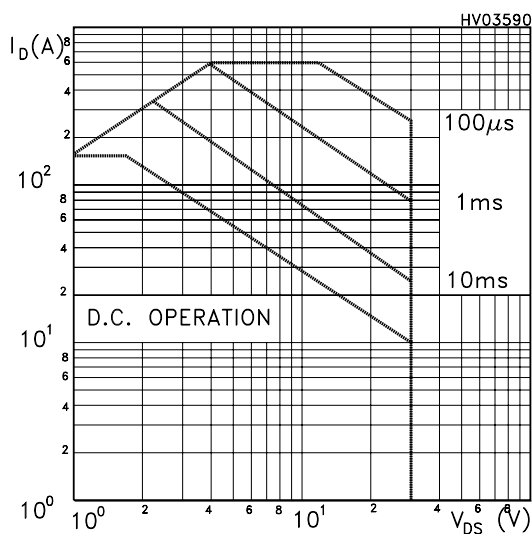

Thermal Impedance

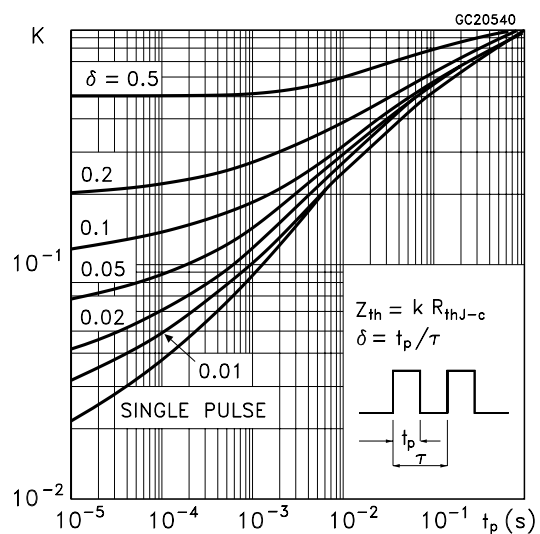

Output Characteristics

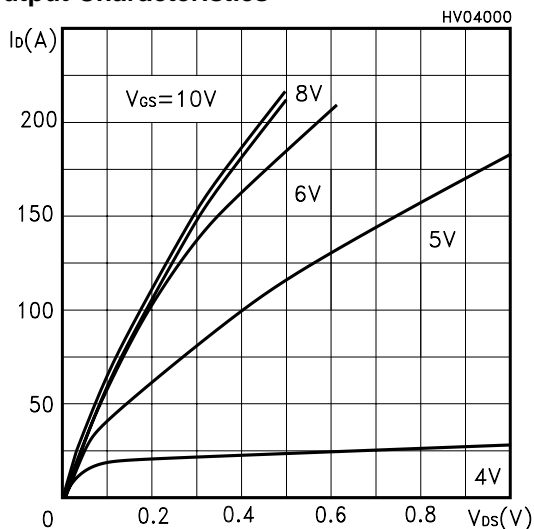

Transfer Characteristics

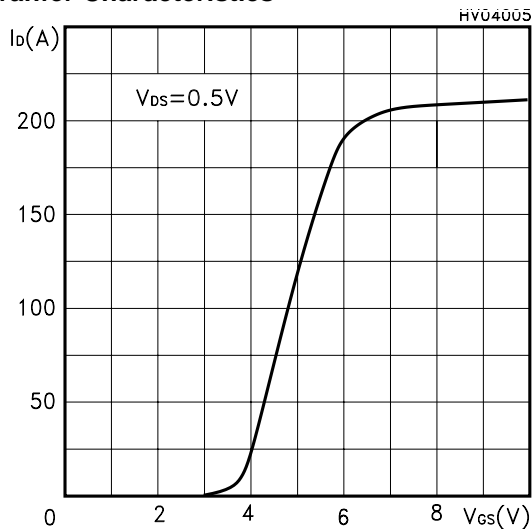

Transconductance

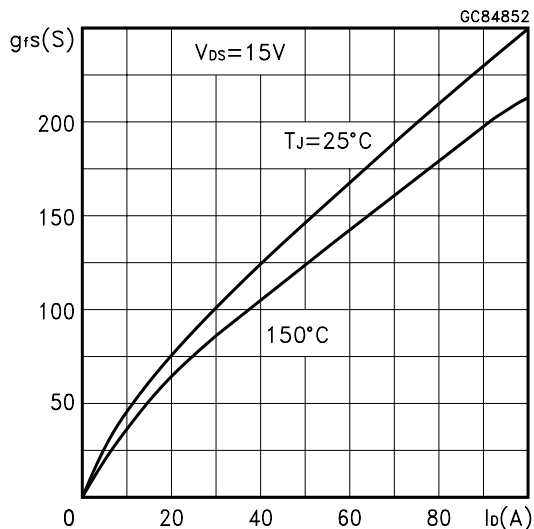

Static Drain-Source On Resistance

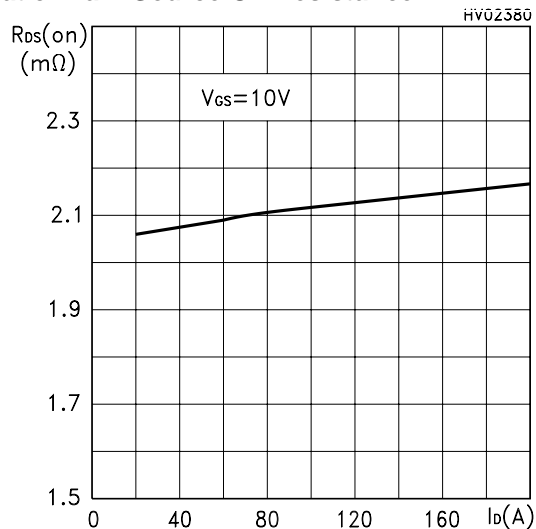

Gate Charge vs Gate-source Voltage

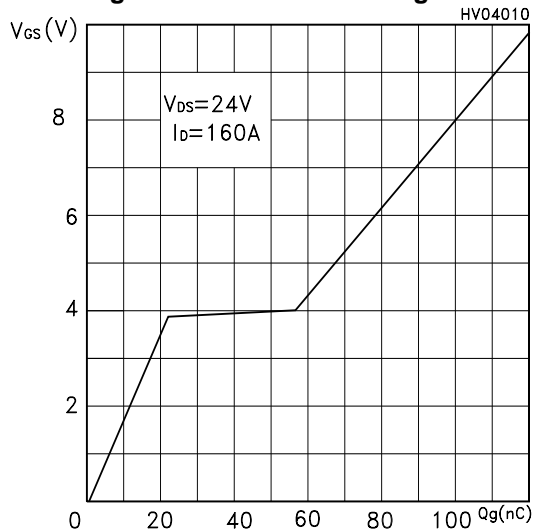

Capacitance Variations

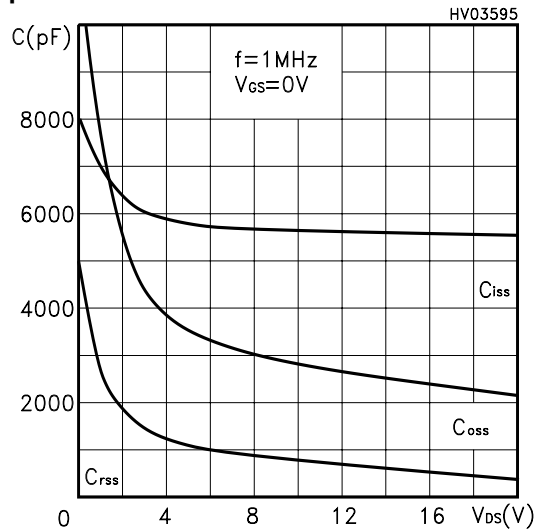

Normalized Gate Thershold Voltage vs Temp.

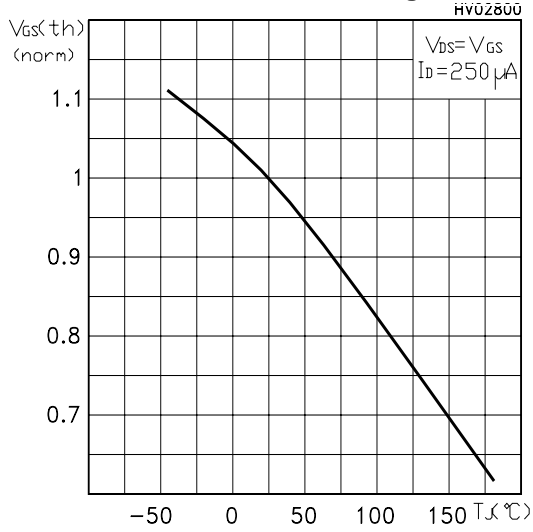

Normalized On Resistance vs Temperature

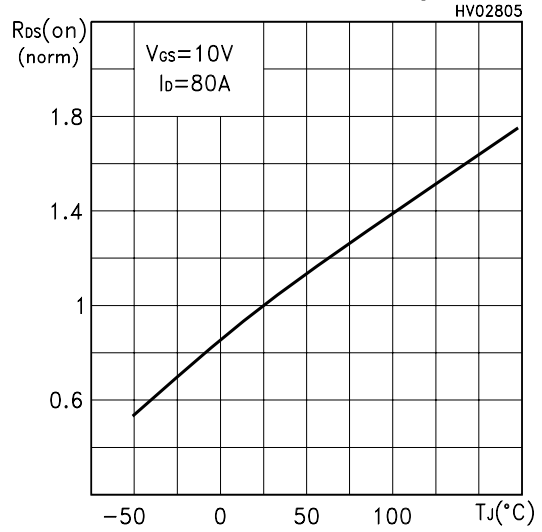

Source-drain Diode Forward Characteristics

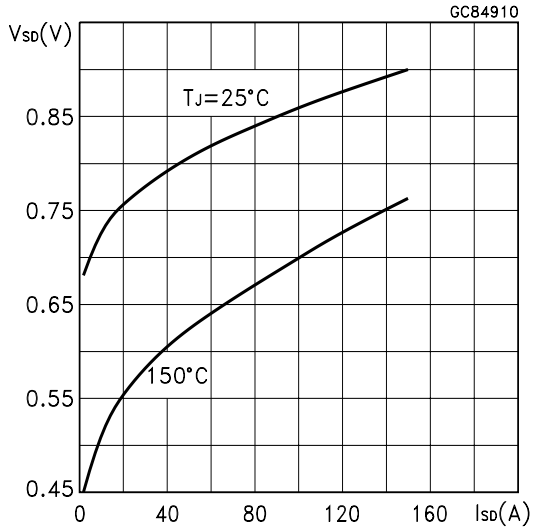

Fig. 1: Unclamped Inductive Load Test Circuit



Fig. 2: Unclamped Inductive Waveform



Fig. 3: Switching Times Test Circuit For Resistive Load



Fig. 4: Gate Charge test Circuit

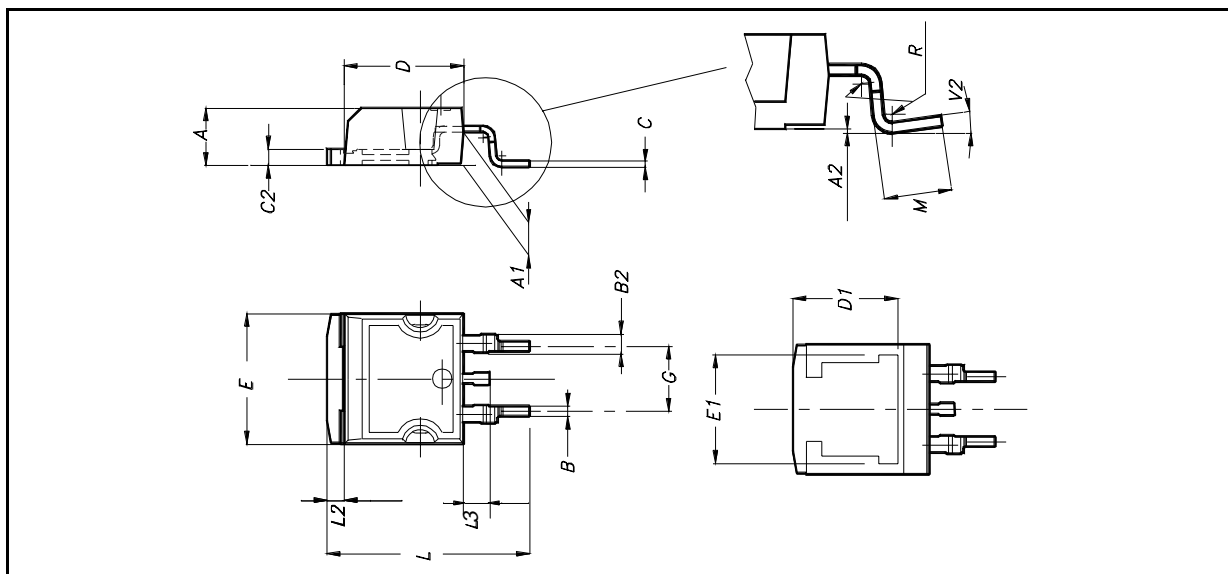

Fig. 5: Test Circuit For Inductive Load Switching And Diode Recovery Times



D²PAK MECHANICAL DATA

DIM.	mm.			inch		
	MIN.	TYP	MAX.	MIN.	TYP.	MAX.
A	4.4		4.6	0.173		0.181
A1	2.49		2.69	0.098		0.106
A2	0.03		0.23	0.001		0.009
B	0.7		0.93	0.027		0.036
B2	1.14		1.7	0.044		0.067
C	0.45		0.6	0.017		0.023
C2	1.23		1.36	0.048		0.053
D	8.95		9.35	0.352		0.368
D1		8			0.315	
E	10		10.4	0.393		
E1		8.5			0.334	
G	4.88		5.28	0.192		0.208
L	15		15.85	0.590		0.625
L2	1.27		1.4	0.050		0.055
L3	1.4		1.75	0.055		0.068
M	2.4		3.2	0.094		0.126
R		0.4			0.015	
V2	0°		8°			



D²PAK FOOTPRINT

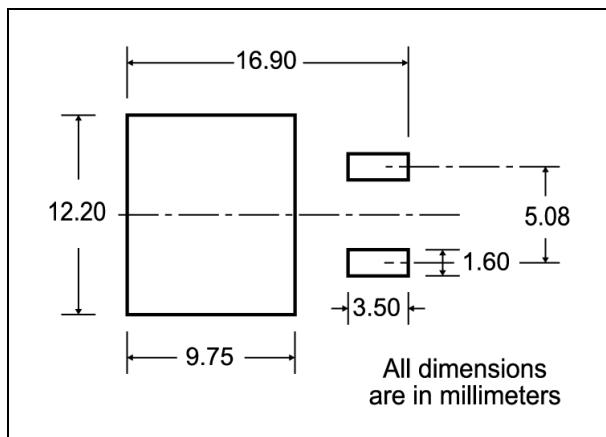

TUBE SHIPMENT (no suffix)*

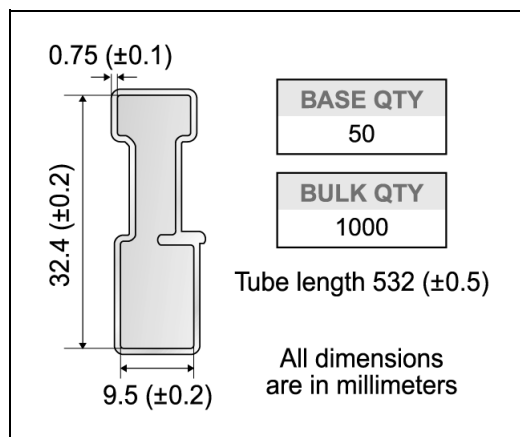

TAPE AND REEL SHIPMENT (suffix "T4")*

40 mm min. Access hole at slot location

Full radius

Tape slot in core for tape start 2.5mm min. width

G measured at hub

TAPE MECHANICAL DATA

DIM.	mm		inch	
	MIN.	MAX.	MIN.	MAX.
A0	10.5	10.7	0.413	0.421
B0	15.7	15.9	0.618	0.626
D	1.5	1.6	0.059	0.063
D1	1.59	1.61	0.062	0.063
E	1.65	1.85	0.065	0.073
F	11.4	11.6	0.449	0.456
K0	4.8	5.0	0.189	0.197
P0	3.9	4.1	0.153	0.161
P1	11.9	12.1	0.468	0.476
P2	1.9	2.1	0.075	0.082
R	50		1.574	
T	0.25	0.35	0.0098	0.0137
W	23.7	24.3	0.933	0.956

REEL MECHANICAL DATA

DIM.	mm		inch	
	MIN.	MAX.	MIN.	MAX.
A		330		12.992
B	1.5		0.059	
C	12.8	13.2	0.504	0.520
D	20.2		0.795	
G	24.4	26.4	0.960	1.039
N	100		3.937	
T		30.4		1.197

BASE QTY	BULK QTY
1000	1000

10 pitches cumulative tolerance on tape +/- 0.2 mm

Center line of cavity

User Direction of Feed

Bending radius R min.

FEED DIRECTION

* on sales type
8/9

Information furnished is believed to be accurate and reliable. However, STMicroelectronics assumes no responsibility for the consequences of use of such information nor for any infringement of patents or other rights of third parties which may result from its use. No license is granted by implication or otherwise under any patent or patent rights of STMicroelectronics. Specification mentioned in this publication are subject to change without notice. This publication supersedes and replaces all information previously supplied. STMicroelectronics products are not authorized for use as critical components in life support devices or systems without express written approval of STMicroelectronics.

The ST logo is a trademark of STMicroelectronics

© 2000 STMicroelectronics – Printed in Italy – All Rights Reserved

STMicroelectronics GROUP OF COMPANIES

Australia - Brazil - China - Finland - France - Germany - Hong Kong - India - Italy - Japan - Malaysia - Malta - Morocco -
Singapore - Spain - Sweden - Switzerland - United Kingdom - U.S.A.

<http://www.st.com>