



STGB7NB60HD

N-CHANNEL 7A - 600V DPAK PowerMESH™ IGBT

TYPE	V _{CES}	V _{CE(sat)}	I _C
STGB7NB60HD	600 V	< 2.8 V	7 A

- HIGH INPUT IMPEDANCE (VOLTAGE DRIVEN)
- LOW ON-VOLTAGE DROP (V_{cesat})
- LOW GATE CHARGE
- HIGH CURRENT CAPABILITY
- VERY HIGH FREQUENCY OPERATION
- OFF LOSSES INCLUDE TAIL CURRENT
- CO-PACKAGED WITH TURBOSWITCH™ ANTIPARALLEL DIODE
- SURFACE-MOUNTING D²PAK (TO-263) POWER PACKAGE IN TAPE & REEL (SUFFIX "T4")

DESCRIPTION

Using the latest high voltage technology based on a patented strip layout, STMicroelectronics has designed an advanced family of IGBTs, the PowerMESH™ IGBTs, with outstanding performances. The suffix "H" identifies a family optimized to achieve very low switching times for high frequency applications (<120kHz).

APPLICATIONS

- HIGH FREQUENCY MOTOR CONTROLS
- SMPS AND PFC IN BOTH HARD SWITCH AND RESONANT TOPOLOGIES

ABSOLUTE MAXIMUM RATINGS

Symbol	Parameter	Value	Unit
V _{CES}	Collector-Emitter Voltage (V _{GS} = 0)	600	V
V _{GE}	Gate-Emitter Voltage	± 20	V
I _C	Collector Current (continuous) at T _c = 25 °C	14	A
I _C	Collector Current (continuous) at T _c = 100 °C	7	A
I _{CM} (•)	Collector Current (pulsed)	56	A
P _{tot}	Total Dissipation at T _c = 25 °C	80	W
	Derating Factor	0.64	W/°C
T _{stg}	Storage Temperature	-65 to 150	°C
T _j	Max. Operating Junction Temperature	150	°C

(•) Pulse width limited by safe operating area

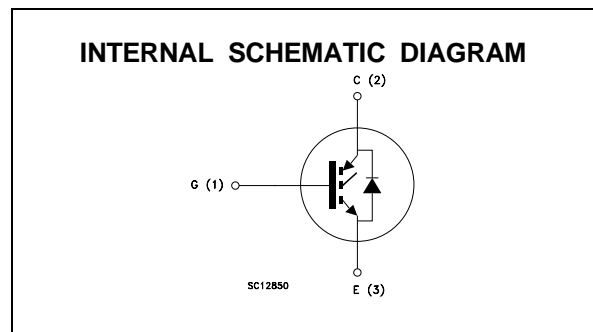
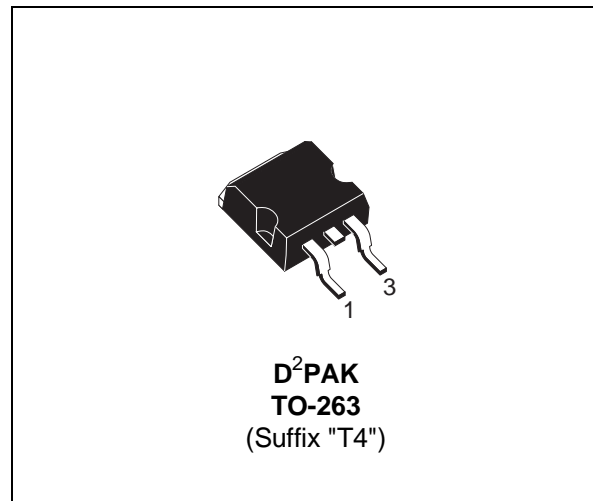

STGB7NB60HD

THERMAL DATA

R _{thj-case}	Thermal Resistance Junction-case	Max	1.56	°C/W
R _{thj-amb}	Thermal Resistance Junction-ambient	Max	62.5	°C/W
R _{thc-sink}	Thermal Resistance Case-sink	Typ	0.5	°C/W

ELECTRICAL CHARACTERISTICS (T_j = 25 °C unless otherwise specified)

OFF

Symbol	Parameter	Test Conditions	Min.	Typ.	Max.	Unit
V _{BR(CES)}	Collector-Emitter Breakdown Voltage	I _C = 250 μA V _{GE} = 0	600			V
I _{CES}	Collector cut-off (V _{GE} = 0)	V _{CE} = Max Rating T _j = 25 °C V _{CE} = Max Rating T _j = 125 °C			250 2000	μA μA
I _{GES}	Gate-Emitter Leakage Current (V _{CE} = 0)	V _{GE} = ± 20 V V _{CE} = 0			± 100	nA

ON (*)

Symbol	Parameter	Test Conditions	Min.	Typ.	Max.	Unit
V _{GE(th)}	Gate Threshold Voltage	V _{CE} = V _{GE} I _C = 250 μA	3		5	V
V _{CE(SAT)}	Collector-Emitter Saturation Voltage	V _{GE} = 15 V I _C = 7 A V _{GE} = 15 V I _C = 7 A T _j = 125 °C		2.3 1.9	2.8	V V

DYNAMIC

Symbol	Parameter	Test Conditions	Min.	Typ.	Max.	Unit
g _{fs}	Forward Transconductance	V _{CE} = 25 V I _C = 7 A	3.5	5		S
C _{ies} C _{oes} C _{res}	Input Capacitance Output Capacitance Reverse Transfer Capacitance	V _{CE} = 25 V f = 1 MHz V _{GE} = 0	390 45 10	560 68 15	730 90 20	pF pF pF
Q _G Q _{GE} Q _{GC}	Total Gate Charge Gate-Emitter Charge Gate-Collector Charge	V _{CE} = 480 V I _C = 7 A V _{GE} = 15 V		42 7.9 17.6	55	nC nC nC
I _{CL}	Latching Current	V _{clamp} = 480 V R _G = 10 Ω T _j = 150 °C	28			A

SWITCHING ON

Symbol	Parameter	Test Conditions	Min.	Typ.	Max.	Unit
t _{d(on)} t _r	Delay Time Rise Time	V _{CC} = 480 V I _C = 7 A V _{GE} = 15 V R _G = 10 Ω		15 48		ns ns
(di/dt) _{on}	Turn-on Current Slope	V _{CC} = 480 V I _C = 7 A R _G = 10 Ω V _{GE} = 15 V		160		A/μs
E _{on(▷)}	Turn-on Switching Losses	T _j = 125 °C		185		μJ

ELECTRICAL CHARACTERISTICS (continued)

SWITCHING OFF

Symbol	Parameter	Test Conditions	Min.	Typ.	Max.	Unit
t_c	Cross-Over Time	$V_{CC} = 480\text{ V}$		85		ns
$t_r(V_{off})$	Off Voltage Rise Time	$I_C = 7\text{ A}$ $R_{GE} = 10\ \Omega$		20		ns
$t_d(off)$	Delay Time	$V_{GE} = 15\text{ V}$		75		ns
t_f	Fall Time			70		ns
$E_{off(**)}$	Turn-off Switching Loss			85		μJ
$E_{ts(\circ)}$	Total Switching Loss			235		μJ
t_c	Cross-Over Time	$V_{CC} = 480\text{ V}$		150		ns
$t_r(V_{off})$	Off Voltage Rise Time	$I_C = 7\text{ A}$ $R_{GE} = 10\ \Omega$		50		ns
$t_d(off)$	Delay Time	$V_{GE} = 15\text{ V}$ $T_j = 125\text{ }^\circ\text{C}$		110		ns
t_f	Fall Time			110		ns
$E_{off(**)}$	Turn-off Switching Loss			220		μJ
$E_{ts(\circ)}$	Total Switching Loss			405		μJ

COLLECTOR-EMITTER DIODE

Symbol	Parameter	Test Conditions	Min.	Typ.	Max.	Unit
I_f	Forward Current				7	A
I_{fm}	Forward Current pulsed				56	A
V_f	Forward On-Voltage	$I_f = 7\text{ A}$ $I_f = 7\text{ A}$		1.6 1.4	2.0	V V
t_{rr}	Reverse Recovery Time	$I_f = 7\text{ A}$		100		ns
Q_{rr}	Reverse Recovery Charge	$dI/dt = 100\text{ A}/\mu\text{S}$		180		nC
I_{rrm}	Reverse Recovery Current	$V_R = 200\text{ V}$ $T_j = 125\text{ }^\circ\text{C}$		3.6		A

- (●) Pulse width limited by max. junction temperature
- (○) Include recovery losses on the STTA506 freewheeling diode
- (*) Pulsed: Pulse duration = 300 μs , duty cycle 1.5 %
- (**) Losses Include Also The Tail (Jedec Standardization)

Thermal Impedance

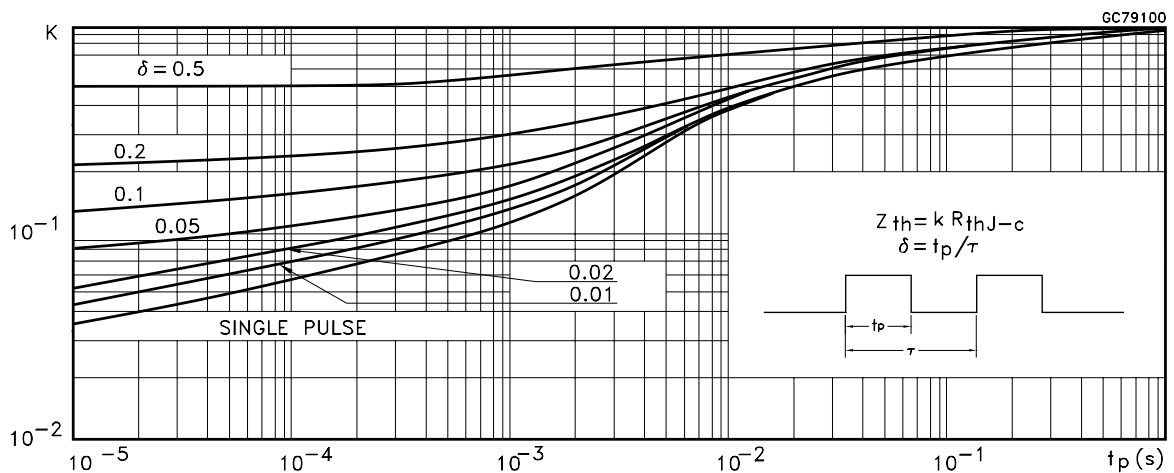

Output Characteristics

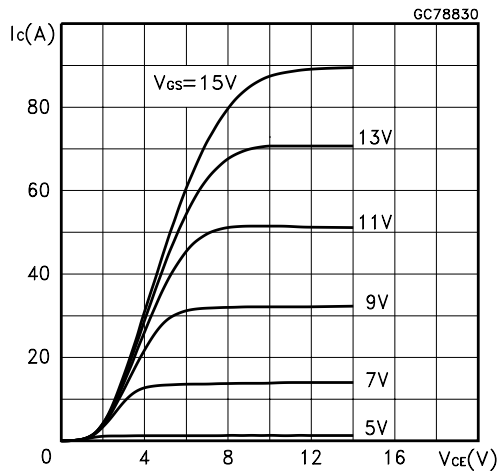

Transfer Characteristics

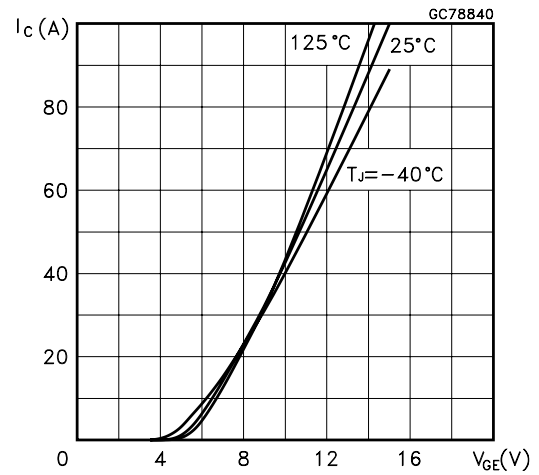

Transconductance

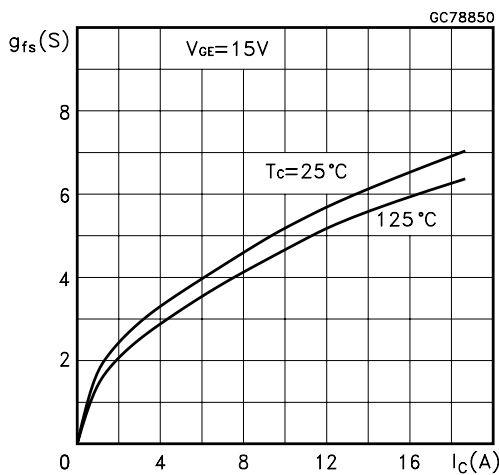

Collector-Emitter On Voltage vs Temperature

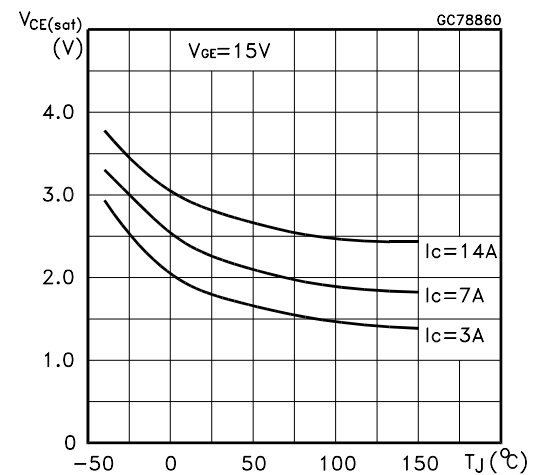

Collector-Emitter On Voltage vs Collector Current

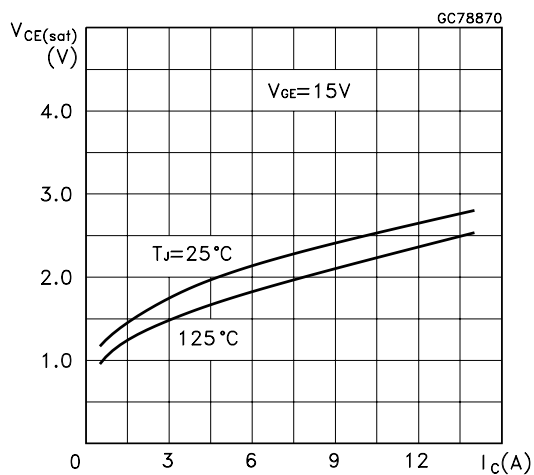

Gate Threshold vs Temperature

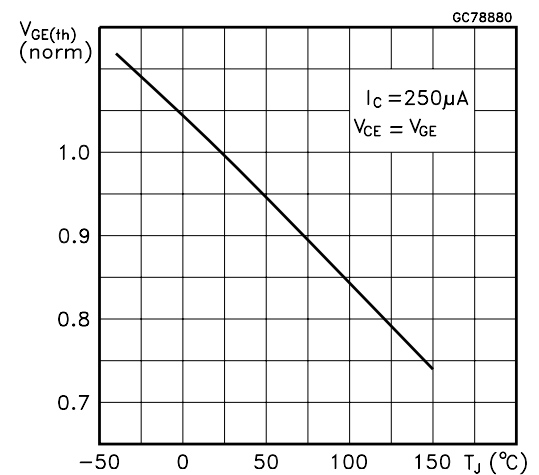

Normalized Breakdown Voltage vs Temperature

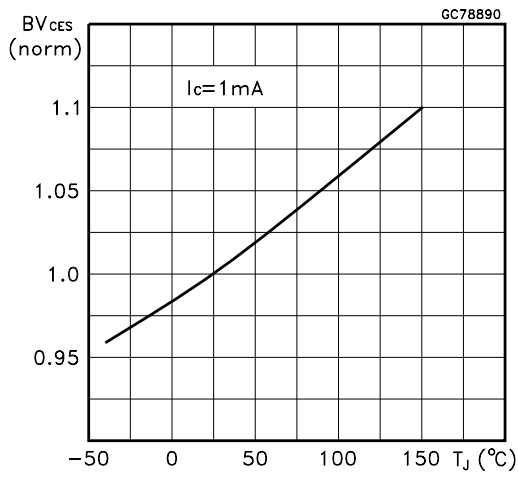

Capacitance Variations

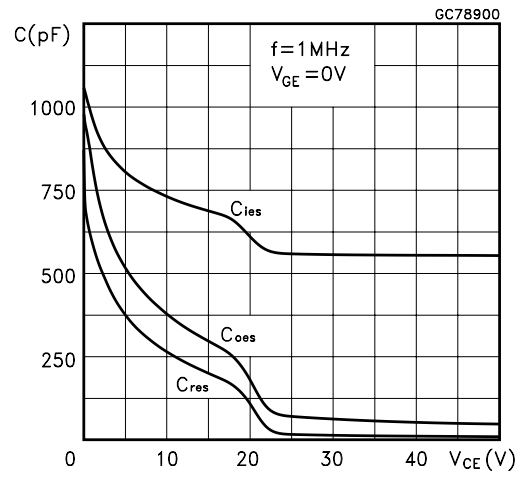

Gate Charge vs Gate-Emitter Voltage

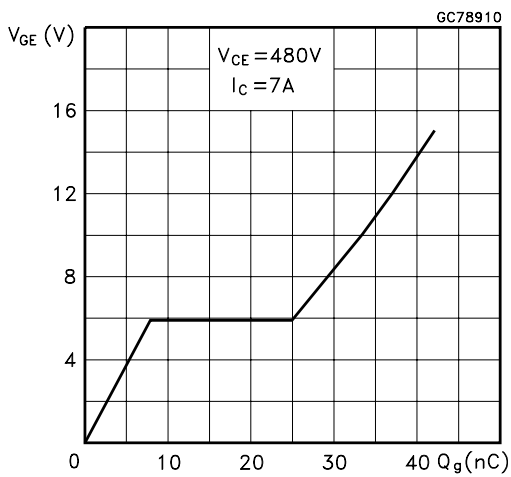

Total Switching Losses vs Gate Resistance

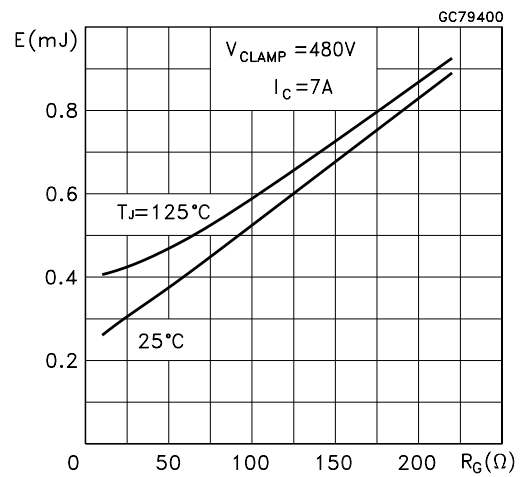

Total Switching Losses vs Temperature

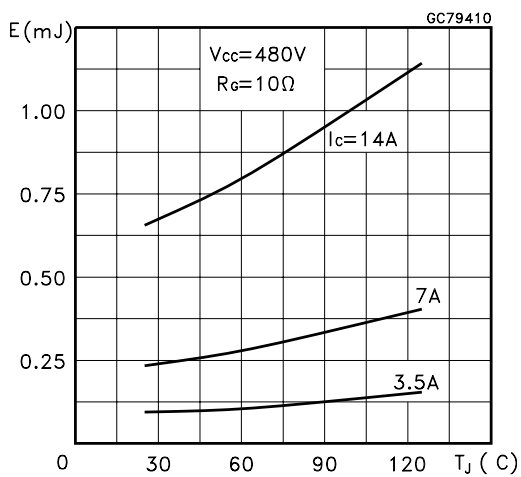

Total Switching Losses vs Collector Current

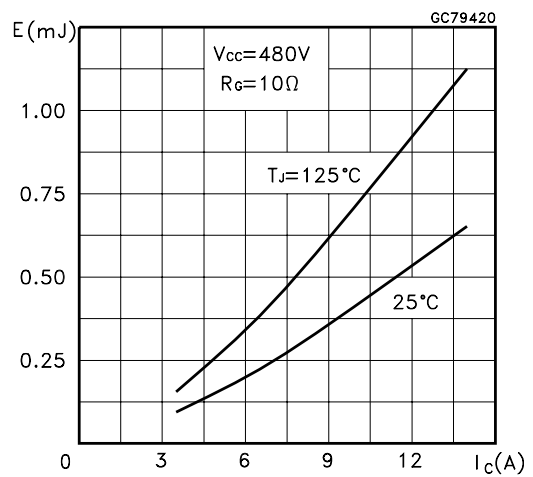

Switching Off Safe Operating Area

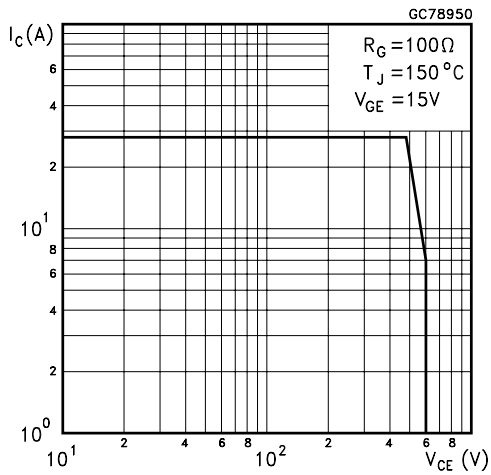

Fig. 1: Gate Charge test Circuit

Diode Forward Voltage

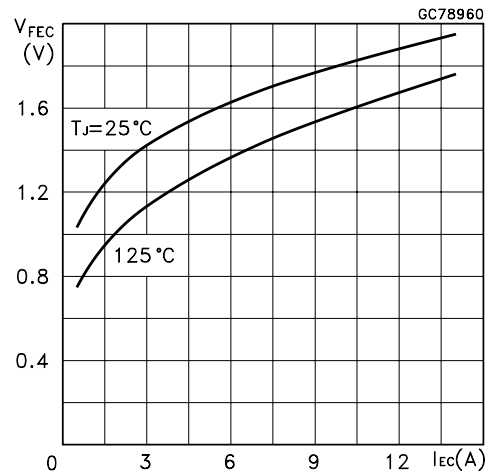

Fig. 2: Test Circuit For Inductive Load Switching

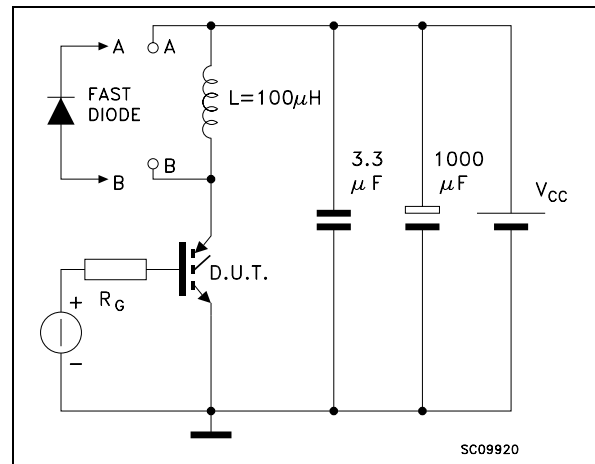
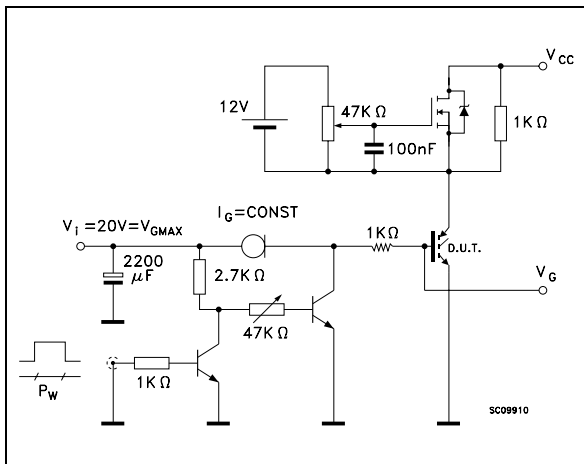
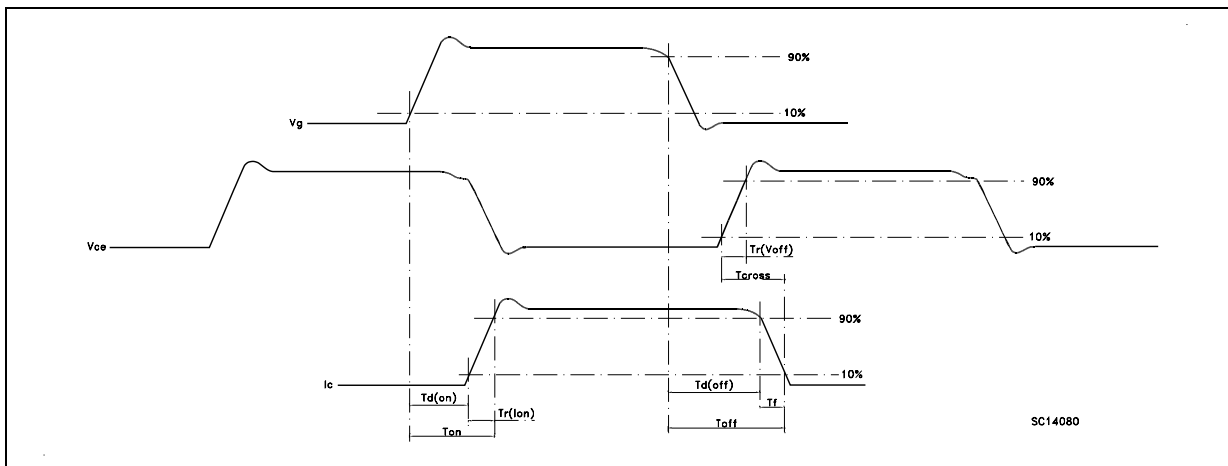
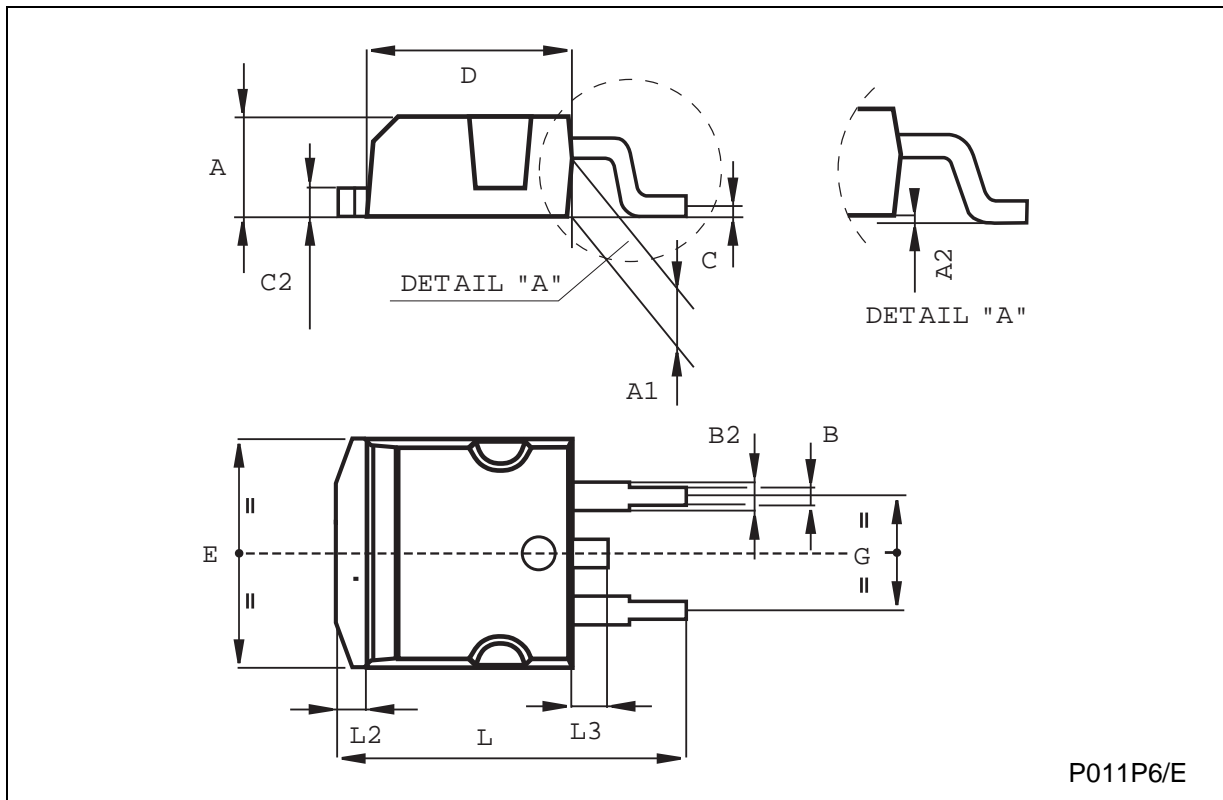

Fig. 3: Switching Waveforms



TO-263 (D²PAK) MECHANICAL DATA

DIM.	mm			inch		
	MIN.	TYP.	MAX.	MIN.	TYP.	MAX.
A	4.4		4.6	0.173		0.181
A1	2.49		2.69	0.098		0.106
B	0.7		0.93	0.027		0.036
B2	1.14		1.7	0.044		0.067
C	0.45		0.6	0.017		0.023
C2	1.21		1.36	0.047		0.053
D	8.95		9.35	0.352		0.368
E	10		10.4	0.393		0.409
G	4.88		5.28	0.192		0.208
L	15		15.85	0.590		0.624
L2	1.27		1.4	0.050		0.055
L3	1.4		1.75	0.055		0.068



Information furnished is believed to be accurate and reliable. However, STMicroelectronics assumes no responsibility for the consequences of use of such information nor for any infringement of patents or other rights of third parties which may result from its use. No license is granted by implication or otherwise under any patent or patent rights of STMicroelectronics. Specification mentioned in this publication are subject to change without notice. This publication supersedes and replaces all information previously supplied. STMicroelectronics products are not authorized for use as critical components in life support devices or systems without express written approval of STMicroelectronics.

The ST logo is a trademark of STMicroelectronics

© 1999 STMicroelectronics – Printed in Italy – All Rights Reserved
STMicroelectronics GROUP OF COMPANIES

Australia - Brazil - China - Finland - France - Germany - Hong Kong - India - Italy - Japan - Malaysia - Malta - Morocco -
Singapore - Spain - Sweden - Switzerland - United Kingdom - U.S.A.

<http://www.st.com>