



# STP8NK80Z - STP8NK80ZFP STW8NK80Z

N-CHANNEL 800V - 1.3Ω - 6.2A TO-220/TO-220FP/TO-247  
Zener-Protected SuperMESH™ Power MOSFET

| TYPE        | V <sub>DSS</sub> | R <sub>DS(on)</sub> | I <sub>D</sub> | P <sub>w</sub> |
|-------------|------------------|---------------------|----------------|----------------|
| STP8NK80Z   | 800 V            | < 1.5 Ω             | 6.2 A          | 140 W          |
| STP8NK80ZFP | 800 V            | < 1.5 Ω             | 6.2 A          | 30 W           |
| STW8NK80Z   | 800 V            | < 1.5 Ω             | 6.2 A          | 140 W          |

- TYPICAL R<sub>DS(on)</sub> = 1.3 Ω
- EXTREMELY HIGH dv/dt CAPABILITY
- 100% AVALANCHE TESTED
- GATE CHARGE MINIMIZED
- VERY LOW INTRINSIC CAPACITANCES
- VERY GOOD MANUFACTURING REPEATABILITY

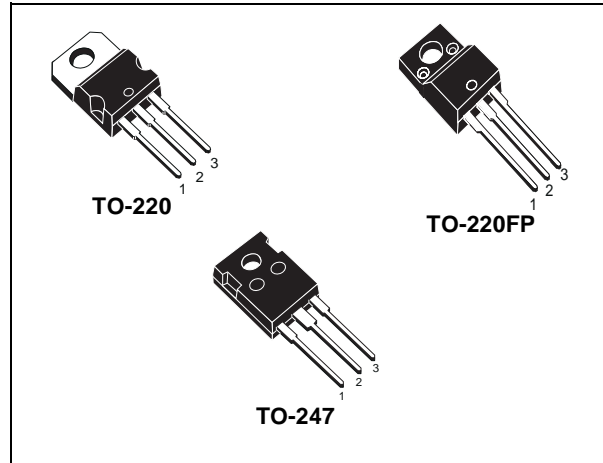

## DESCRIPTION

The SuperMESH™ series is obtained through an extreme optimization of ST's well established strip-based PowerMESH™ layout. In addition to pushing on-resistance significantly down, special care is taken to ensure a very good dv/dt capability for the most demanding applications. Such series complements ST full range of high voltage MOSFETs including revolutionary MDmesh™ products.

## APPLICATIONS

- HIGH CURRENT, HIGH SPEED SWITCHING
- IDEAL FOR OFF-LINE POWER SUPPLIES, ADAPTORS AND PFC
- LIGHTING

## INTERNAL SCHEMATIC DIAGRAM



## ORDERING INFORMATION

| SALES TYPE  | MARKING   | PACKAGE  | PACKAGING |
|-------------|-----------|----------|-----------|
| STP8NK80Z   | P8NK80Z   | TO-220   | TUBE      |
| STP8NK80ZFP | P8NK80ZFP | TO-220FP | TUBE      |
| STW8NK80Z   | W8NK80Z   | TO-247   | TUBE      |

## STP8NK80Z - STP8NK80ZFP - STW8NK80Z

### ABSOLUTE MAXIMUM RATINGS

| Symbol             | Parameter   | Value                 |             | Unit                |
|--------------------|---|-----------------------|-------------|---------------------|
|                    |   | STP8NK80Z - STW8NK80Z | STP8NK80ZFP |                     |
| $V_{DS}$           | Drain-source Voltage ( $V_{GS} = 0$ )                   | 800                   |             | V                   |
| $V_{DGR}$          | Drain-gate Voltage ( $R_{GS} = 20 \text{ k}\Omega$ )    | 800                   |             | V                   |
| $V_{GS}$           | Gate- source Voltage                                    | $\pm 30$              |             | V                   |
| $I_D$              | Drain Current (continuous) at $T_C = 25^\circ\text{C}$  | 6.2                   | 6.2 (*)     | A                   |
| $I_D$              | Drain Current (continuous) at $T_C = 100^\circ\text{C}$ | 3.9                   | 3.9 (*)     | A                   |
| $I_{DM} (\bullet)$ | Drain Current (pulsed)                                  | 24.8                  | 24.8 (*)    | A                   |
| $P_{TOT}$          | Total Dissipation at $T_C = 25^\circ\text{C}$           | 140                   | 30          | W                   |
|                    | Derating Factor   | 1.12                  | 0.24        | W/ $^\circ\text{C}$ |
| $V_{ESD(G-S)}$     | Gate source ESD(HBM-C=100pF, R=1.5 K $\Omega$ )         | 4000                  |             | V                   |
| dv/dt (1)          | Peak Diode Recovery voltage slope                       | 4.5                   |             | V/ns                |
| $V_{ISO}$          | Insulation Withstand Voltage (DC)                       | -                     | 2500        | V                   |
| $T_j$<br>$T_{stg}$ | Operating Junction Temperature<br>Storage Temperature   | -55 to 150            |             | $^\circ\text{C}$    |

( $\bullet$ ) Pulse width limited by safe operating area

(1)  $I_{SD} \leq 6.2\text{A}$ ,  $di/dt \leq 200 \text{ A}/\mu\text{s}$ ,  $V_{DD} \leq V_{(BR)DSS}$ ,  $T_j \leq T_{JMAX}$ .

(\*) Limited only by maximum temperature allowed

### THERMAL DATA

|           |  | TO-220 | TO-220FP | TO-247 |                           |
|-----------|--|--------|----------|--------|---------------------------|
| Rthj-case | Thermal Resistance Junction-case Max           | 0.89   | 4.2      | 0.89   | $^\circ\text{C}/\text{W}$ |
| Rthj-amb  | Thermal Resistance Junction-ambient Max        | 62.5   |          | 50     | $^\circ\text{C}/\text{W}$ |
| $T_l$     | Maximum Lead Temperature For Soldering Purpose | 300    |          |        | $^\circ\text{C}$          |

### AVALANCHE CHARACTERISTICS

| Symbol   | Parameter   | Max Value | Unit |
|----------|---|-----------|------|
| $I_{AR}$ | Avalanche Current, Repetitive or Not-Repetitive (pulse width limited by $T_j$ max)                            | 6.2       | A    |
| $E_{AS}$ | Single Pulse Avalanche Energy (starting $T_j = 25^\circ\text{C}$ , $I_D = I_{AR}$ , $V_{DD} = 50 \text{ V}$ ) | 300       | mJ   |

### GATE-SOURCE ZENER DIODE

| Symbol     | Parameter                     | Test Conditions                          | Min. | Typ. | Max. | Unit |
|------------|-------------------------------|--|------|------|------|------|
| $BV_{GSO}$ | Gate-Source Breakdown Voltage | $I_{gs} = \pm 1 \text{ mA}$ (Open Drain) | 30   |      |      | V    |

### PROTECTION FEATURES OF GATE-TO-SOURCE ZENER DIODES

The built-in back-to-back Zener diodes have specifically been designed to enhance not only the device's ESD capability, but also to make them safely absorb possible voltage transients that may occasionally be applied from gate to source. In this respect the Zener voltage is appropriate to achieve an efficient and cost-effective intervention to protect the device's integrity. These integrated Zener diodes thus avoid the usage of external components.

## STP8NK80Z - STP8NK80ZFP - STW8NK80Z

### ELECTRICAL CHARACTERISTICS (T<sub>CASE</sub> = 25°C UNLESS OTHERWISE SPECIFIED) ON/OFF

| Symbol               | Parameter   | Test Conditions   | Min. | Typ. | Max.    | Unit     |
|----------------------|---|---|------|------|---------|----------|
| V <sub>(BR)DSS</sub> | Drain-source Breakdown Voltage                        | I <sub>D</sub> = 1 mA, V <sub>GS</sub> = 0  | 800  |      |         | V        |
| I <sub>DSS</sub>     | Zero Gate Voltage Drain Current (V <sub>GS</sub> = 0) | V <sub>DS</sub> = Max Rating<br>V <sub>DS</sub> = Max Rating, T <sub>C</sub> = 125 °C |      |      | 1<br>50 | μA<br>μA |
| I <sub>GSS</sub>     | Gate-body Leakage Current (V <sub>DS</sub> = 0)       | V <sub>GS</sub> = ± 20V   |      |      | ±10     | μA       |
| V <sub>GS(th)</sub>  | Gate Threshold Voltage                                | V <sub>DS</sub> = V <sub>GS</sub> , I <sub>D</sub> = 100 μA                           | 3    | 3.75 | 4.5     | V        |
| R <sub>DSON</sub>    | Static Drain-source On Resistance                     | V <sub>GS</sub> = 10 V, I <sub>D</sub> = 3.1 A  |      | 1.3  | 1.5     | Ω        |

### DYNAMIC

| Symbol   | Parameter   | Test Conditions  | Min. | Typ.              | Max. | Unit           |
|--|---|--|------|-------------------|------|----------------|
| g <sub>fs</sub> (1)                                      | Forward Transconductance  | V <sub>DS</sub> = 15 V, I <sub>D</sub> = 3.1 A         |      | 5.2               |      | S              |
| C <sub>iss</sub><br>C <sub>oss</sub><br>C <sub>rss</sub> | Input Capacitance<br>Output Capacitance<br>Reverse Transfer Capacitance | V <sub>DS</sub> = 25 V, f = 1 MHz, V <sub>GS</sub> = 0 |      | 1320<br>143<br>27 |      | pF<br>pF<br>pF |
| C <sub>oss eq.</sub> (3)                                 | Equivalent Output Capacitance   | V <sub>GS</sub> = 0, V <sub>DS</sub> = 640 V           |      | 58                |      | pF             |

### SWITCHING ON

| Symbol   | Parameter  | Test Conditions  | Min. | Typ.            | Max. | Unit           |
|--|--|--|------|-----------------|------|----------------|
| t <sub>d(on)</sub><br>t <sub>r</sub>                 | Turn-on Delay Time<br>Rise Time                              | V <sub>DD</sub> = 400 V, I <sub>D</sub> = 3.1 A<br>R <sub>G</sub> = 4.7Ω, V <sub>GS</sub> = 10 V<br>(Resistive Load see, Figure 3) |      | 17<br>30        |      | ns<br>ns       |
| Q <sub>g</sub><br>Q <sub>gs</sub><br>Q <sub>gd</sub> | Total Gate Charge<br>Gate-Source Charge<br>Gate-Drain Charge | V <sub>DD</sub> = 640 V, I <sub>D</sub> = 6.2 A,<br>V <sub>GS</sub> = 10 V   |      | 46<br>8.5<br>25 |      | nC<br>nC<br>nC |

### SWITCHING OFF

| Symbol   | Parameter   | Test Conditions  | Min. | Typ.         | Max. | Unit           |
|--|---|--|------|--------------|------|----------------|
| t <sub>d(off)</sub><br>t <sub>f</sub>                    | Turn-off Delay Time<br>Fall Time                      | V <sub>DD</sub> = 400 V, I <sub>D</sub> = 3.1 A<br>R <sub>G</sub> = 4.7Ω, V <sub>GS</sub> = 10 V<br>(Resistive Load see, Figure 3) |      | 48<br>28     |      | ns<br>ns       |
| t <sub>r(Voff)</sub><br>t <sub>f</sub><br>t <sub>c</sub> | Off-voltage Rise Time<br>Fall Time<br>Cross-over Time | V <sub>DD</sub> = 640V, I <sub>D</sub> = 6.2 A,<br>R <sub>G</sub> = 4.7Ω, V <sub>GS</sub> = 10 V<br>(Inductive Load see, Figure 5) |      | 9<br>9<br>18 |      | ns<br>ns<br>ns |

### SOURCE DRAIN DIODE

| Symbol   | Parameter  | Test Conditions   | Min. | Typ.              | Max.        | Unit          |
|--|--|---|------|-------------------|-------------|---------------|
| I <sub>SD</sub><br>I <sub>SDM</sub> (2)                | Source-drain Current<br>Source-drain Current (pulsed)                        |   |      |                   | 6.2<br>24.8 | A<br>A        |
| V <sub>SD</sub> (1)                                    | Forward On Voltage   | I <sub>SD</sub> = 6.2 A, V <sub>GS</sub> = 0  |      |                   | 1.6         | V             |
| t <sub>rr</sub><br>Q <sub>rr</sub><br>I <sub>RRM</sub> | Reverse Recovery Time<br>Reverse Recovery Charge<br>Reverse Recovery Current | I <sub>SD</sub> = 6.2 A, di/dt = 100 A/μs<br>V <sub>DD</sub> = 50 V, T <sub>j</sub> = 150°C<br>(see test circuit, Figure 5) |      | 460<br>2990<br>13 |             | ns<br>nC<br>A |

Note: 1. Pulsed: Pulse duration = 300 μs, duty cycle 1.5 %.

2. Pulse width limited by safe operating area.

3. C<sub>oss eq.</sub> is defined as a constant equivalent capacitance giving the same charging time as C<sub>oss</sub> when V<sub>DS</sub> increases from 0 to 80% V<sub>DSS</sub>.

Safe Operating Area For TO-220

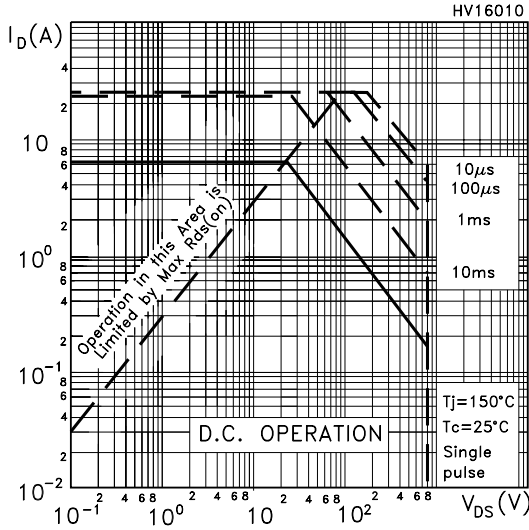

Thermal Impedance For TO-220

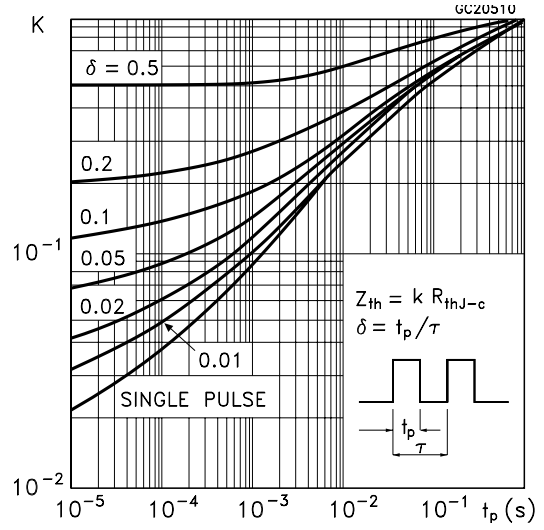

Safe Operating Area For TO-220FP

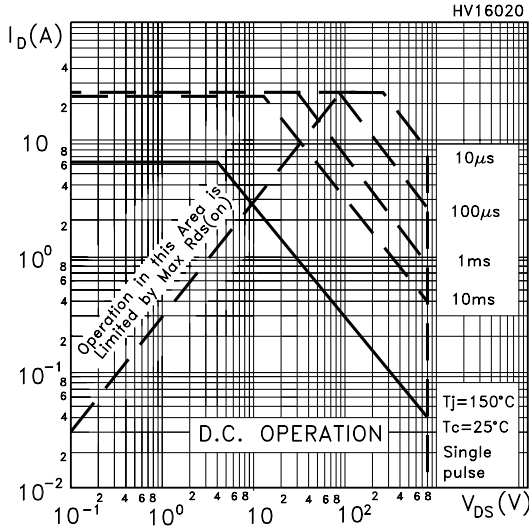

Thermal Impedance For TO-220FP

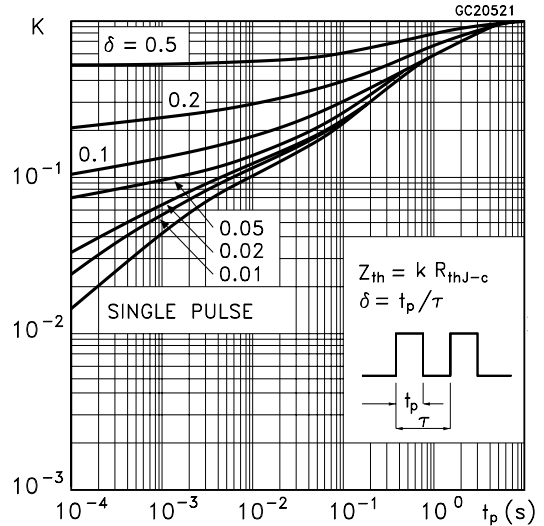

Safe Operating Area For TO-247

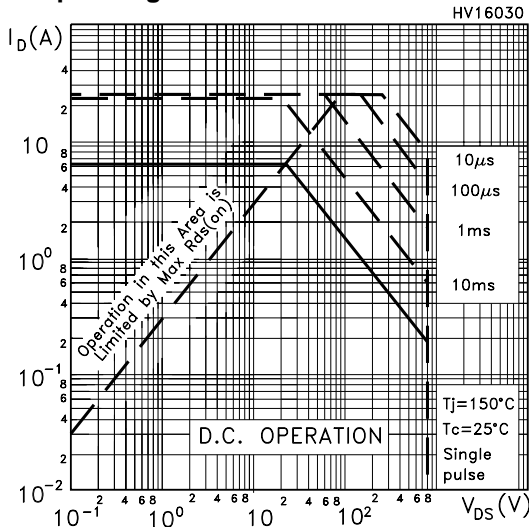

Thermal Impedance For TO-247

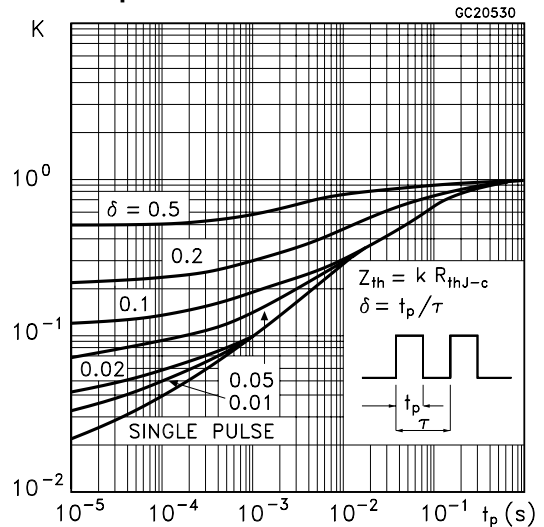

**Output Characteristics**

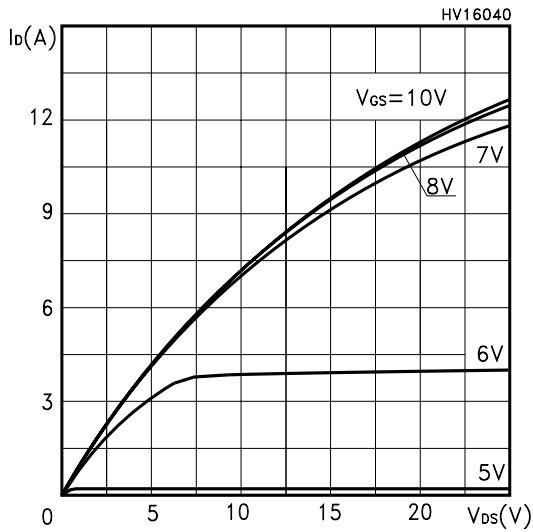

**Transfer Characteristics**

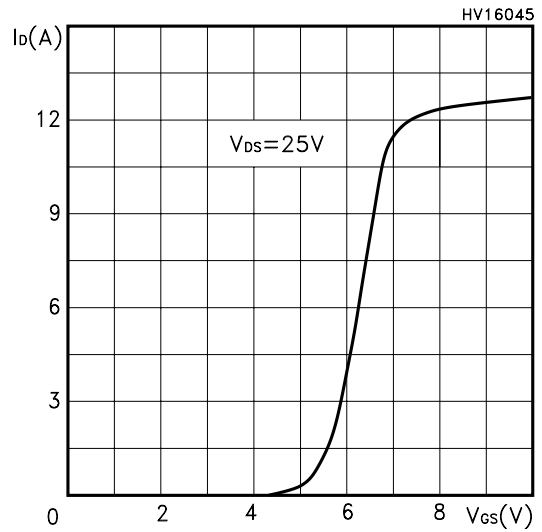

**Transconductance**

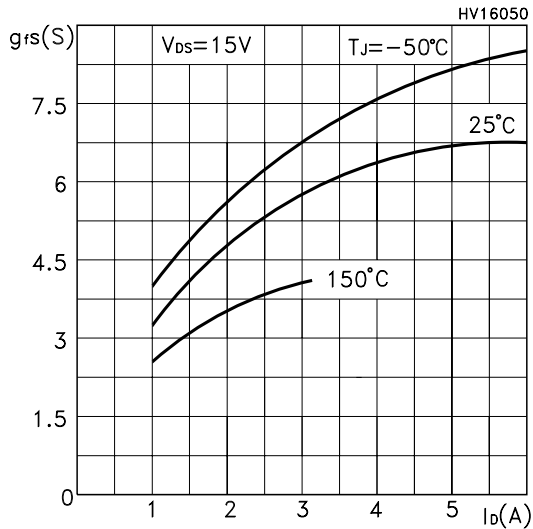

**Static Drain-source On Resistance**

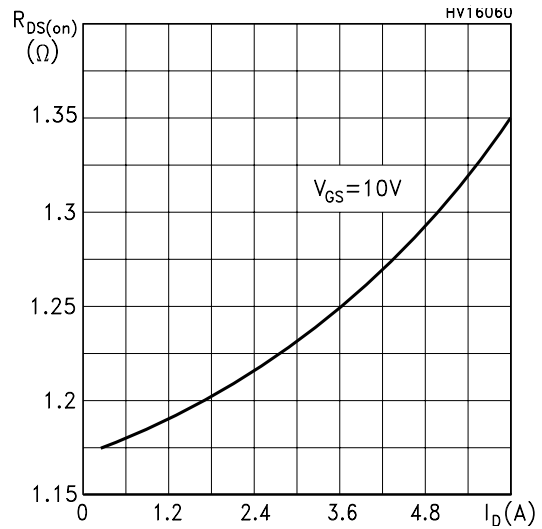

**Gate Charge vs Gate-source Voltage**

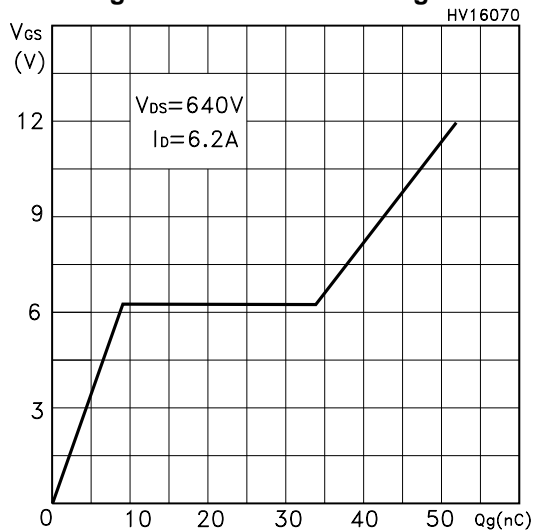

**Capacitance Variations**

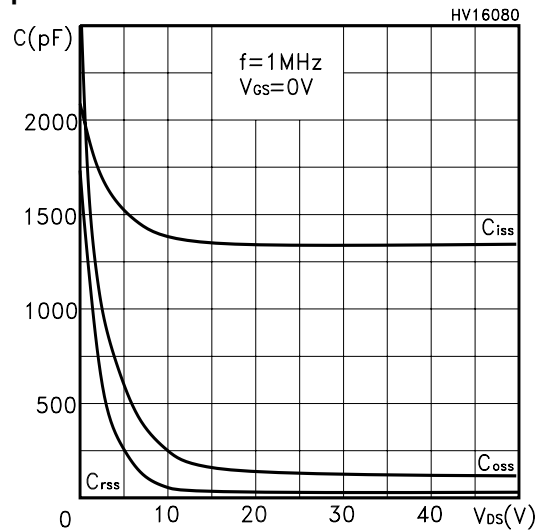

Normalized Gate Threshold Voltage vs Temp.

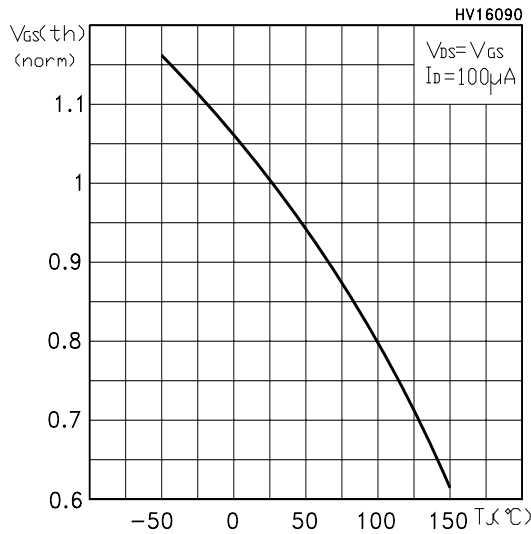

Normalized On Resistance vs Temperature

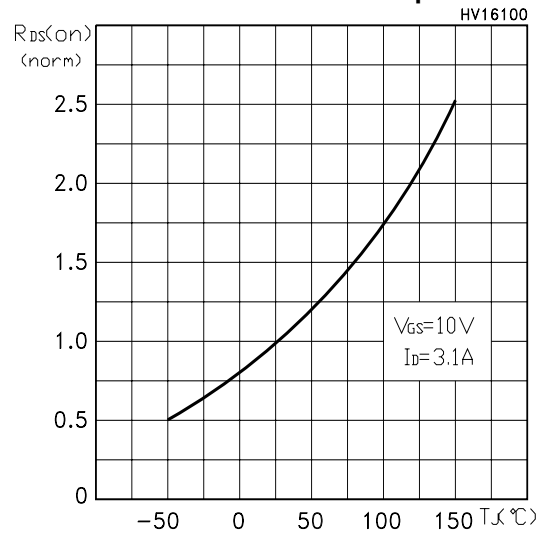

Source-drain Diode Forward Characteristics

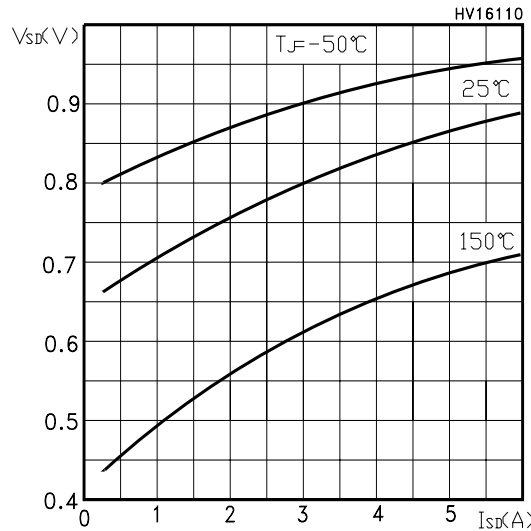

Normalized BVDSS vs Temperature

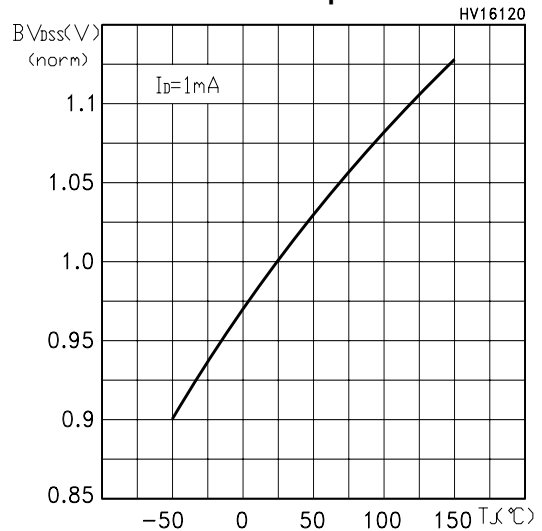

Maximum Avalanche Energy vs Temperature

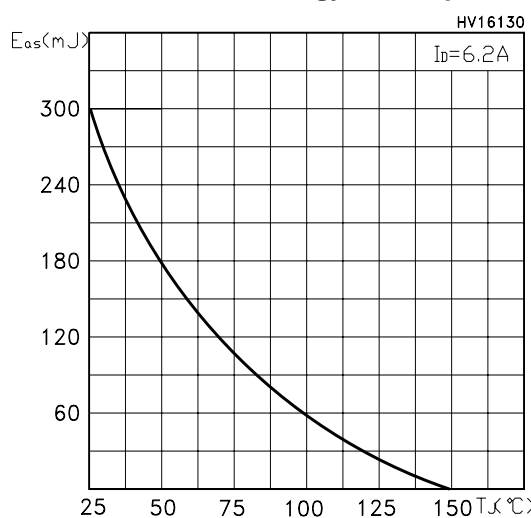

**Fig. 1: Unclamped Inductive Load Test Circuit**



**Fig. 2: Unclamped Inductive Waveform**



**Fig. 3: Switching Times Test Circuit For Resistive Load**



**Fig. 4: Gate Charge test Circuit**

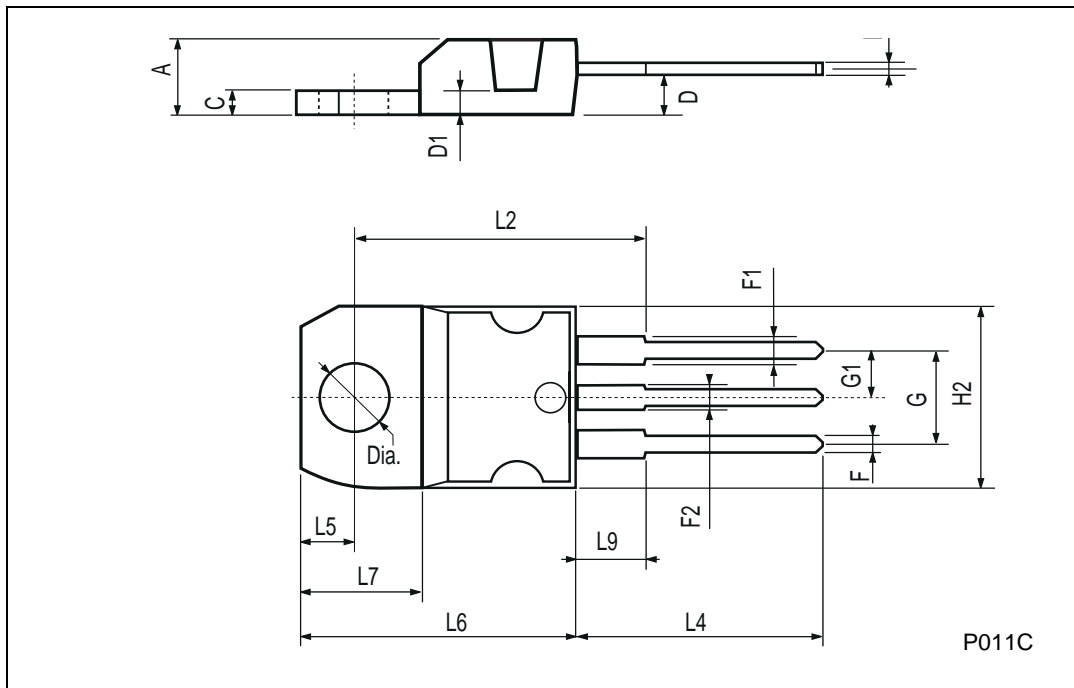

**Fig. 5: Test Circuit For Inductive Load Switching And Diode Recovery Times**



TO-220 MECHANICAL DATA

| DIM. | mm    |      |       | inch  |       |       |
|------|-------|------|-------|-------|-------|-------|
|      | MIN.  | TYP. | MAX.  | MIN.  | TYP.  | MAX.  |
| A    | 4.40  |      | 4.60  | 0.173 |       | 0.181 |
| C    | 1.23  |      | 1.32  | 0.048 |       | 0.051 |
| D    | 2.40  |      | 2.72  | 0.094 |       | 0.107 |
| D1   |       | 1.27 |       |       | 0.050 |       |
| E    | 0.49  |      | 0.70  | 0.019 |       | 0.027 |
| F    | 0.61  |      | 0.88  | 0.024 |       | 0.034 |
| F1   | 1.14  |      | 1.70  | 0.044 |       | 0.067 |
| F2   | 1.14  |      | 1.70  | 0.044 |       | 0.067 |
| G    | 4.95  |      | 5.15  | 0.194 |       | 0.203 |
| G1   | 2.4   |      | 2.7   | 0.094 |       | 0.106 |
| H2   | 10.0  |      | 10.40 | 0.393 |       | 0.409 |
| L2   |       | 16.4 |       |       | 0.645 |       |
| L4   | 13.0  |      | 14.0  | 0.511 |       | 0.551 |
| L5   | 2.65  |      | 2.95  | 0.104 |       | 0.116 |
| L6   | 15.25 |      | 15.75 | 0.600 |       | 0.620 |
| L7   | 6.2   |      | 6.6   | 0.244 |       | 0.260 |
| L9   | 3.5   |      | 3.93  | 0.137 |       | 0.154 |
| DIA. | 3.75  |      | 3.85  | 0.147 |       | 0.151 |



P011C





TO-247 MECHANICAL DATA

| DIM. | mm   |      |      | inch  |       |       |
|------|------|------|------|-------|-------|-------|
|      | MIN. | TYP. | MAX. | MIN.  | TYP.  | MAX.  |
| A    | 4.7  |      | 5.3  | 0.185 |       | 0.209 |
| D    | 2.2  |      | 2.6  | 0.087 |       | 0.102 |
| E    | 0.4  |      | 0.8  | 0.016 |       | 0.031 |
| F    | 1    |      | 1.4  | 0.039 |       | 0.055 |
| F3   | 2    |      | 2.4  | 0.079 |       | 0.094 |
| F4   | 3    |      | 3.4  | 0.118 |       | 0.134 |
| G    |      | 10.9 |      |       | 0.429 |       |
| H    | 15.3 |      | 15.9 | 0.602 |       | 0.626 |
| L    | 19.7 |      | 20.3 | 0.776 |       | 0.779 |
| L3   | 14.2 |      | 14.8 | 0.559 |       | 0.582 |
| L4   |      | 34.6 |      |       | 1.362 |       |
| L5   |      | 5.5  |      |       | 0.217 |       |
| M    | 2    |      | 3    | 0.079 |       | 0.118 |

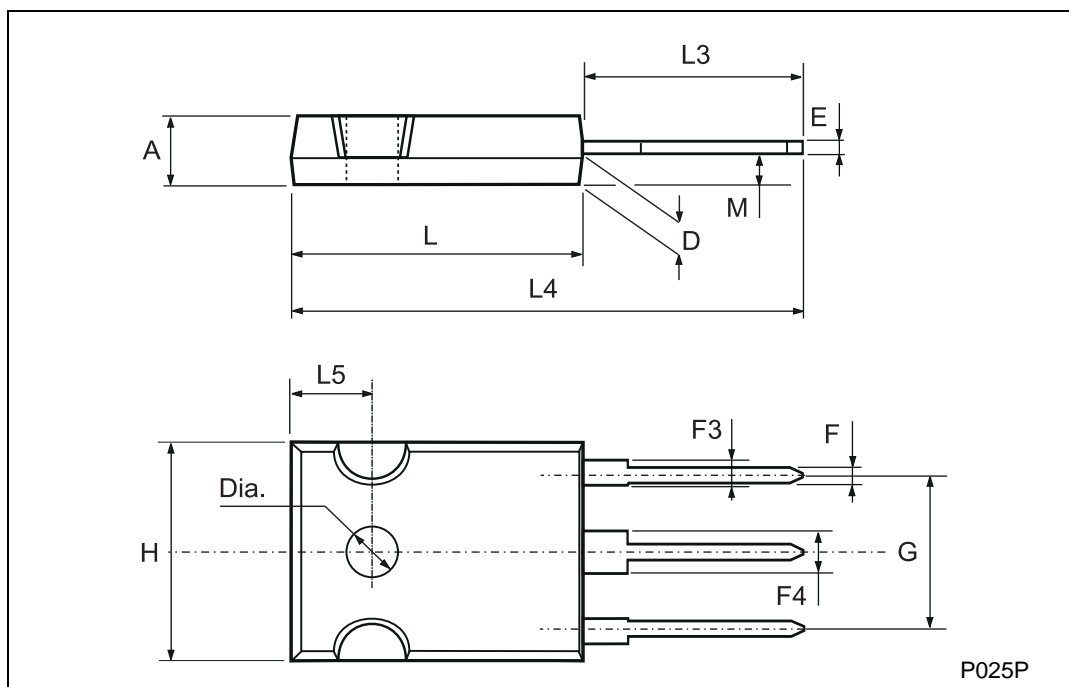

Information furnished is believed to be accurate and reliable. However, STMicroelectronics assumes no responsibility for the consequences of use of such information nor for any infringement of patents or other rights of third parties which may result from its use. No license is granted by implication or otherwise under any patent or patent rights of STMicroelectronics. Specifications mentioned in this publication are subject to change without notice. This publication supersedes and replaces all information previously supplied. STMicroelectronics products are not authorized for use as critical components in life support devices or systems without express written approval of STMicroelectronics.

© The ST logo is a registered trademark of STMicroelectronics

© 2003 STMicroelectronics - Printed in Italy - All Rights Reserved  
STMicroelectronics GROUP OF COMPANIES

Australia - Brazil - Canada - China - Finland - France - Germany - Hong Kong - India - Israel - Italy - Japan - Malaysia - Malta - Morocco  
Singapore - Spain - Sweden - Switzerland - United Kingdom - United States.

© <http://www.st.com>