

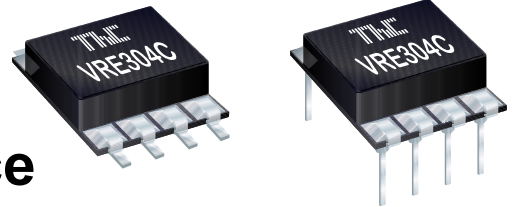

# VRE304

## Low Cost Precision Reference



THALER CORPORATION • 2015 N. FORBES BOULEVARD • TUCSON, AZ. 85745 • (520) 882-4000

### FEATURES

- 4.500 V OUTPUT  $\pm$  0.450 mV (.01%)
- TEMPERATURE DRIFT: 0.6 ppm/°C
- LOW NOISE: 3 $\mu$ V<sub>p-p</sub> (0.1-10Hz)
- INDUSTRY STD PINOUT- 8 PIN DIP OR SURFACE MOUNT PACKAGE
- EXCELLENT LINE REGULATION: 6ppm/V Typ.
- OUTPUT TRIM CAPABILITY

### PIN CONFIGURATION

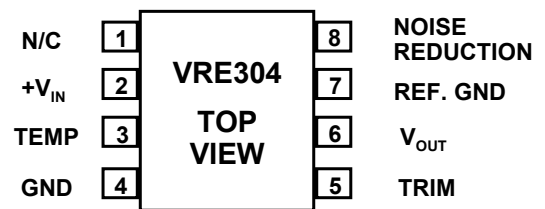

FIGURE 1

### DESCRIPTION

The VRE304 is a low cost, high precision 4.5V reference. Packaged in the industry standard 8 pin DIP, the device is ideal for upgrading systems that use lower performance references.

The device provides ultrastable +4.500V output with  $\pm$ 0.4500 mV (.01%) initial accuracy and a temperature coefficient of 0.6 ppm/°C. This improvement in accuracy is made possible by a unique, patented multipoint laser compensation technique developed by Thaler Corporation. Significant improvements have been made in other performance parameters as well, including initial accuracy, warm-up drift, line regulation, and long-term stability, making the VRE304 series the most accurate reference available in the standard 8 pin DIP package.

For enhanced performance, the VRE304 has an external trim option for users who want less than 0.01% initial error. For ultra low noise applications, an external capacitor can be attached between the noise reduction pin and the ground pin. A reference ground pin is provided to eliminate socket contact resistance errors.

The VRE304 is recommended for use as a reference for 14, 16, or 18 bit D/A converters which require an external precision reference. The device is also ideal for calibrating scale factor on high resolution A/D converters. The VRE304 offers superior performance over monolithic references.

### SELECTION GUIDE

Model	Initial Error mV	Temp. Coeff. ppm/°C	Temp. Range °C
VRE304A	0.45	0.6	0°C to +70°C
VRE304B	0.70	1.0	0°C to +70°C
VRE304C	0.90	2.0	0°C to +70°C
VRE304J	0.45	0.6	-40°C to +85°C
VRE304K	0.70	1.0	-40°C to +85°C
VRE304L	0.90	2.0	-40°C to +85°C

For package option add D for DIP or S for Surface Mount to end of model number.

# ELECTRICAL SPECIFICATIONS

# VRE304

V<sub>ps</sub> = +15V, T = 25°C, R<sub>L</sub> = 10KΩ unless otherwise noted.

MODEL	A/J			B/K			C/L			
PARAMETER	MIN	TYP	MAX	MIN	TYP	MAX	MIN	TYP	MAX	UNITS
<b>ABSOLUTE RATINGS</b>										
Power Supply	+13.5	+15	+22	*	*	*	*	*	*	V
Operating Temp. (A,B,C)	0		+70	*		*	*		*	°C
Operating Temp. (J,K,L)	-40		+85	*		*	*		*	°C
Storage Temperature	-65		+150	*		*	*		*	°C
Short Circuit Protection	Continuous				*			*		
<b>OUTPUT VOLTAGE</b>										
VRE304 (1) Temp. Sensor Voltage		4.500 630			*			*		V mV
<b>OUTPUT VOLTAGE ERRORS</b>										
Initial Error (2)			0.45			0.70			0.90	mV
Warmup Drift T <sub>min</sub> - T <sub>max</sub> (3)		1			2			3		ppm ppm/°C
Long-Term Stability		6			*			*		ppm/1000hrs
Noise (.1-10Hz) (4)		3			*			*		μVpp
<b>OUTPUT CURRENT</b>										
Range	±10			*			*			mA
<b>REGULATION</b>										
Line		6	10		*	*		*	*	ppm/V
Load		3			*			*		ppm/mA
<b>OUTPUT ADJUSTMENT</b>										
Range		10			*			*		mV
<b>POWER SUPPLY CURRENTS (5)</b>										
VRE304 +PS		5	7		*	*		*	*	mA

NOTES: \*Same as A/J Models.

- The temp. reference TC is 2.1mV/ °C
- The specified values are without external trim.
- The temperature coefficient is determined by the box method using the following formula:

$$T.C. = \frac{V_{max} - V_{min}}{V_{nominal} \times (T_{max} - T_{min})} \times 10^6$$

- The specified values are without the external noise reduction capacitor.
- The specified values are unloaded.

# TYPICAL PERFORMANCE CURVES

**V<sub>OUT</sub> vs. TEMPERATURE**

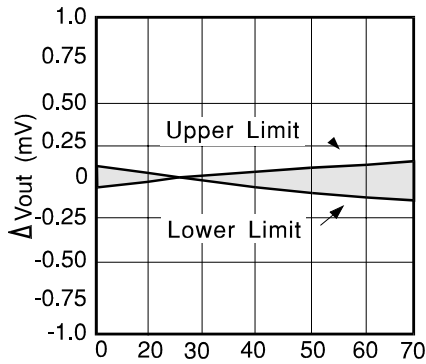

**Temperature °C  
VRE304A**

**V<sub>OUT</sub> vs. TEMPERATURE**

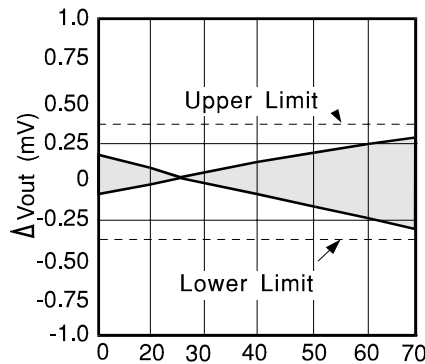

**Temperature °C  
VRE304B**

**V<sub>OUT</sub> vs. TEMPERATURE**

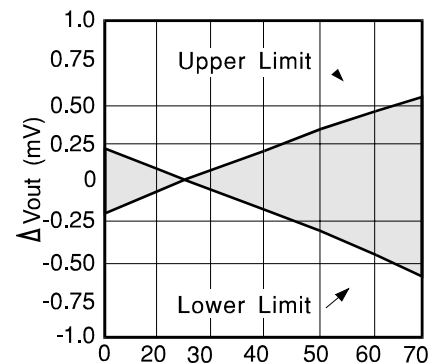

**Temperature °C  
VRE304C**

**V<sub>OUT</sub> vs. TEMPERATURE**

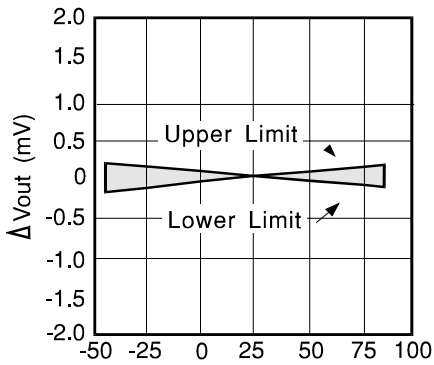

**Temperature °C  
VRE304J**

**V<sub>OUT</sub> vs. TEMPERATURE**

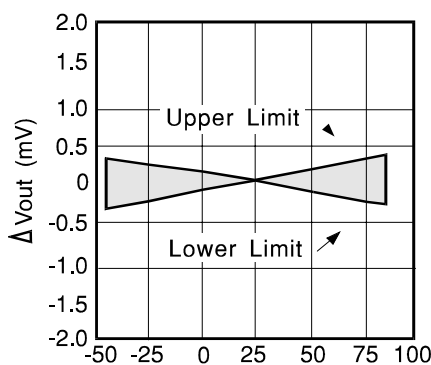

**Temperature °C  
VRE304K**

**V<sub>OUT</sub> vs. TEMPERATURE**

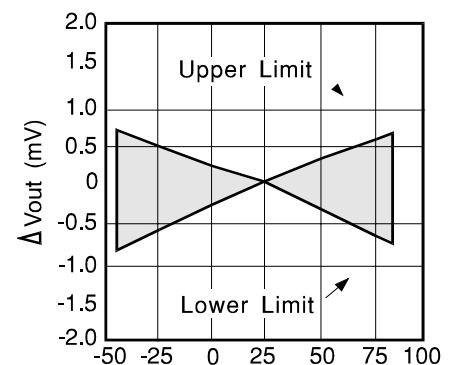

**Temperature °C  
VRE304L**

**QUIESCENT CURRENT vs. TEMP**

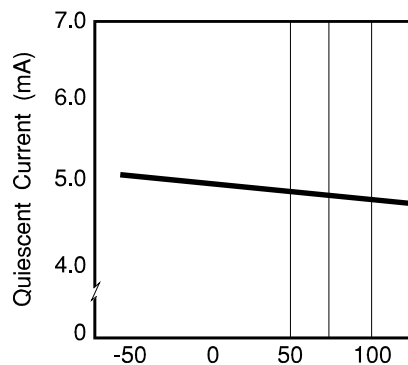

**Temperature °C**

**JUNCTION TEMP. RISE vs. OUTPUT CURRENT**

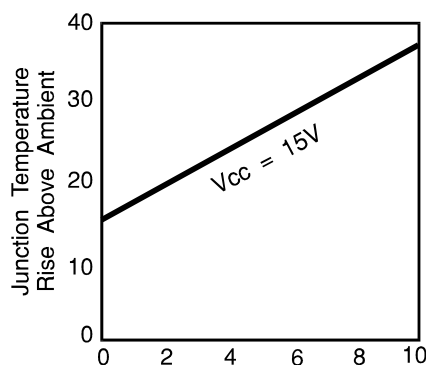

**Output Current (mA)**

**PSRR vs. FREQUENCY**

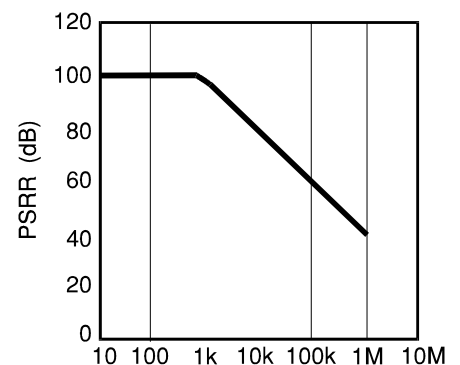

**Frequency (Hz)**

# DISCUSSION OF PERFORMANCE

## THEORY OF OPERATION

The following discussion refers to the schematic in figure 2 below. A FET current source is used to bias a 6.3V zener diode. The zener voltage is divided by the resistor network R1 and R2. This voltage is then applied to the noninverting input of the operational amplifier which amplifies the voltage to produce a 4.500V output. The gain is determined by the resistor networks R3 and R4:  $G=1 + R4/R3$ . The 6.3V zener diode is used because it is the most stable diode over time and temperature.

The current source provides a closely regulated zener current, which determines the slope of the references' voltage vs. temperature function. By trimming the zener current a lower drift over temperature can be achieved. But since the voltage vs. temperature function is nonlinear this compensation technique is not well suited for wide temperature ranges.

Thaler Corporation has developed a nonlinear compensation network of thermistors and resistors that is used in the VRE series voltage references. This proprietary network eliminates most of the nonlinearity in the voltage vs. temperature function. By adjusting the slope, Thaler Corporation produces a very stable voltage over wide temperature ranges.

This network is less than 2% of the overall network resistance so it has a negligible effect on long term stability.

Figure 3 shows the proper connection of the VRE304 series voltage references with the optional trim resistor for initial error and the optional capacitor for noise reduction. The VRE304 reference has the ground terminal brought out on two pins (pin 4 and pin 7) which are connected together internally. This allows the user to achieve greater accuracy when using a socket. Voltage references have a voltage drop across their power supply ground pin due to quiescent current flowing through the contact resistance. If the contact resistance was constant with time and temperature, this voltage drop could be trimmed out. When the reference is plugged into a socket, this source of error can be as high as 20ppm. By connecting pin 4 to the power supply ground and pin 7 to a high impedance ground point in the measurement circuit, the error due to the contact resistance can be eliminated. If the unit is soldered into place, the contact resistance is sufficiently small that it does not effect performance. Pay careful attention to the circuit layout to avoid noise pickup and voltage drops in the lines.

## VRE304

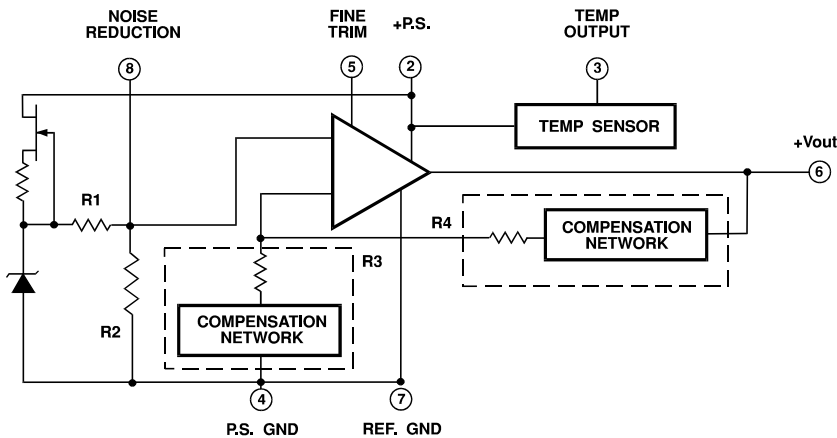

FIGURE 2

## EXTERNAL CONNECTIONS

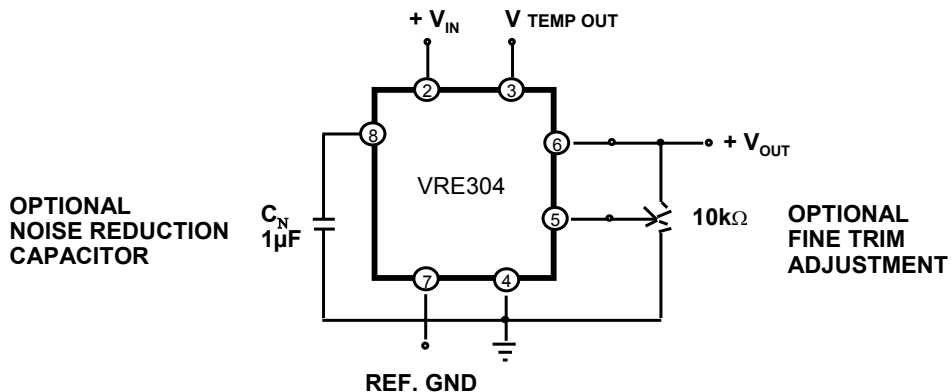
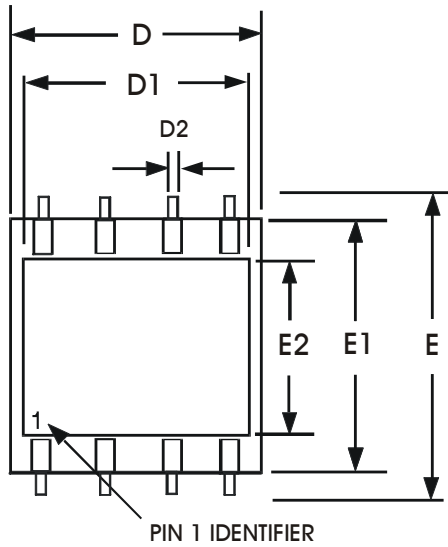

FIGURE 3

# MECHANICAL

FIGURE 3



DIM	INCHES		MILLIMETER		DIM	INCHES		MILLIMETER	
	MIN	MAX	MIN	MAX		MIN	MAX	MIN	MAX
A	.115	.125	2.92	3.17	D2	.018	.023	0.46	0.58
B	.098	.102	2.48	2.59	E	.507	.513	12.8	13.0
B1	.046	.051	1.14	1.29	E1	.397	.403	10.0	10.2
C	.107	.113	2.71	2.89	E2	.264	.270	6.70	6.85
C1	.009	.012	0.22	0.30	P	.085	.095	2.15	2.41
C2	.052	.058	1.32	1.47	Q	.020	.030	.508	.762
D	.397	.403	10.0	10.2	S	.045	.055	1.14	1.39
D1	.372	.380	9.44	9.65					

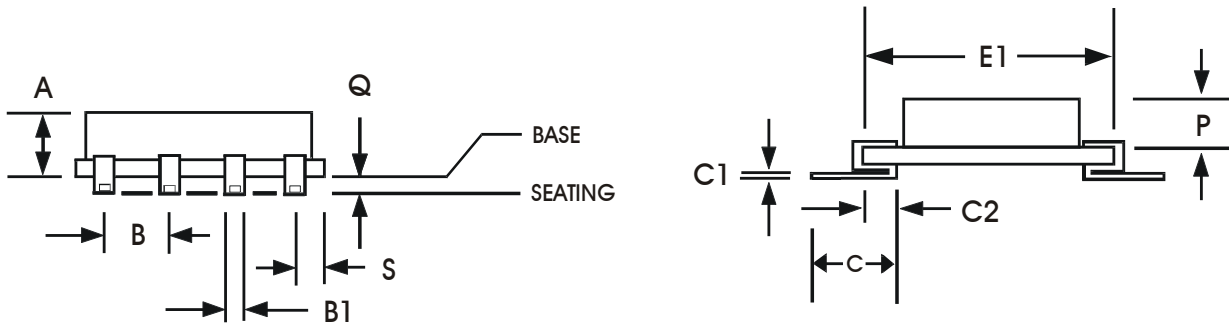
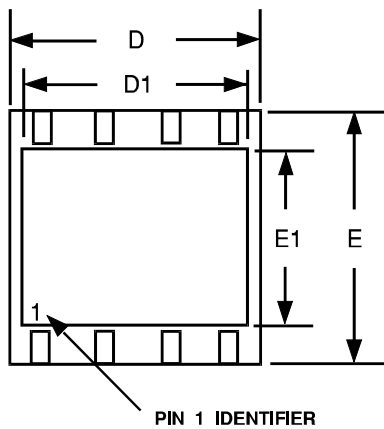

FIGURE 4



DIM	INCHES		MILLIMETER		DIM	INCHES		MILLIMETER	
	MIN	MAX	MIN	MAX		MIN	MAX	MIN	MAX
A	.115	.125	2.92	3.17	E	.397	.403	10.0	10.2
B	.018	.022	.457	.558	E1	.264	.270	6.70	6.85
B1	.046	.051	1.14	1.29	G1	.290	.310	7.36	7.87
B2	.098	.102	2.48	2.59	L	.195	.215	4.95	5.46
C	.009	.012	0.22	0.30	P	.085	.095	2.15	2.41
D	.397	.403	10.0	10.2	Q	.055	.065	1.39	1.65
D 1	.372	.380	9.44	9.65	S	.045	.055	1.14	1.39

