

- High-Resolution Conversion of Light Intensity to Frequency With No External Components
- Communicates Directly With a Microcontroller
- Compact Three-Leaded Clear-Plastic Package
- Single-Supply Operation Down to 2.7 V
- Nonlinearity Error Typically 0.2% at 100 kHz
- Stable 150 ppm/°C Temperature Coefficient
- Single-Supply Operation

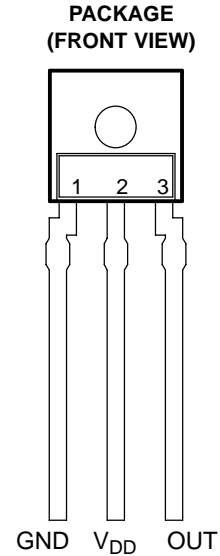

## Description

The TSL235R light-to-frequency converter combines a silicon photodiode and a current-to-frequency converter on a single monolithic CMOS integrated circuit. Output is a square wave (50% duty cycle) with frequency directly proportional to light intensity (irradiance) on the photodiode. The digital output allows direct interface to a microcontroller or other logic circuitry. The device has been temperature compensated for the ultraviolet-to-visible light range of 320 nm to 700 nm and responds over the light range of 320 nm to 1050 nm. The TSL235R is characterized for operation over the temperature range of -25°C to 70°C and is supplied in a 3-lead clear plastic side-looker package with an integral lens.

## Functional Block Diagram



# TSL235R LIGHT-TO-FREQUENCY CONVERTER

TAOS038 – APRIL 2002

## Absolute Maximum Ratings over operating free-air temperature range (unless otherwise noted)†

Supply voltage, $V_{DD}$ (see Note 1) .....	6 V
Operating free-air temperature range, $T_A$ .....	-25°C to 70°C
Storage temperature range, $T_{stg}$ .....	-25°C to 85°C
Lead temperature 1,6 mm (1/16 inch) from case for 10 seconds .....	240°C

† Stresses beyond those listed under “absolute maximum ratings” may cause permanent damage to the device. These are stress ratings only, and functional operation of the device at these or any other conditions beyond those indicated under “recommended operating conditions” is not implied. Exposure to absolute-maximum-rated conditions for extended periods may affect device reliability.

NOTE 1: All voltage values are with respect to GND.

## Recommended Operating Conditions

	MIN	NOM	MAX	UNIT
Supply voltage, $V_{DD}$	2.7	5	5.5	V
Operating free-air temperature range, $T_A$	-25		70	°C

## Electrical Characteristics at $V_{DD} = 5\text{ V}$ , $T_A = 25^\circ\text{C}$ (unless otherwise noted)

PARAMETER		TEST CONDITIONS	MIN	TYP	MAX	UNIT
$V_{OH}$	High-level output voltage	$I_{OH} = -4\text{ mA}$	4	4.5		V
$V_{OL}$	Low-level output voltage	$I_{OL} = 4\text{ mA}$		0.25	0.4	V
$I_{DD}$	Supply current			2	3	mA
	Full-scale frequency‡		500			kHz
	Temperature coefficient of output frequency	Wavelength < 700nm		±150		ppm/°C
$k_{SVS}$	Supply-voltage sensitivity	$V_{DD} = 5\text{ V} \pm 10\%$		±0.5		%/V

‡ Full-scale frequency is the maximum operating frequency of the device without saturation.

## Operating Characteristics at $V_{DD} = 5\text{ V}$ , $T_A = 25^\circ\text{C}$

PARAMETER		TEST CONDITIONS	MIN	TYP	MAX	UNIT
$f_O$	Output frequency	$E_e = 430\ \mu\text{W}/\text{cm}^2$ , $\lambda_p = 635\text{ nm}$	200	250	300	kHz
		$E_e = 0\ \mu\text{W}/\text{cm}^2$		0.4	10	Hz
Nonlinearity§		$f_O = 0\text{ kHz to } 10\text{ kHz}$		±0.1%		%F.S.
		$f_O = 0\text{ kHz to } 100\text{ kHz}$		±0.2%		%F.S.
	Step response to full-scale step input			1 pulse of new frequency plus 1 $\mu\text{s}$		

‡ Full-scale frequency is the maximum operating frequency of the device without saturation.

§ Nonlinearity is defined as the deviation of  $f_O$  from a straight line between zero and full scale, expressed as a percent of full scale.

TYPICAL CHARACTERISTICS

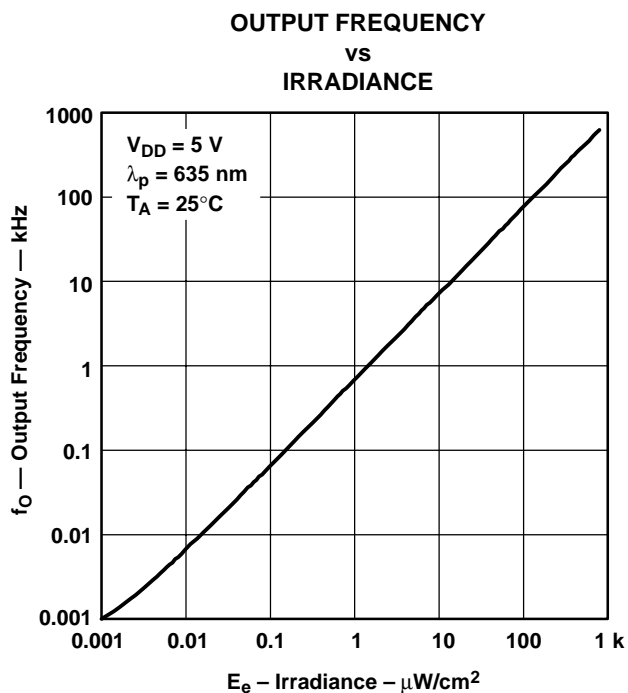

Figure 1

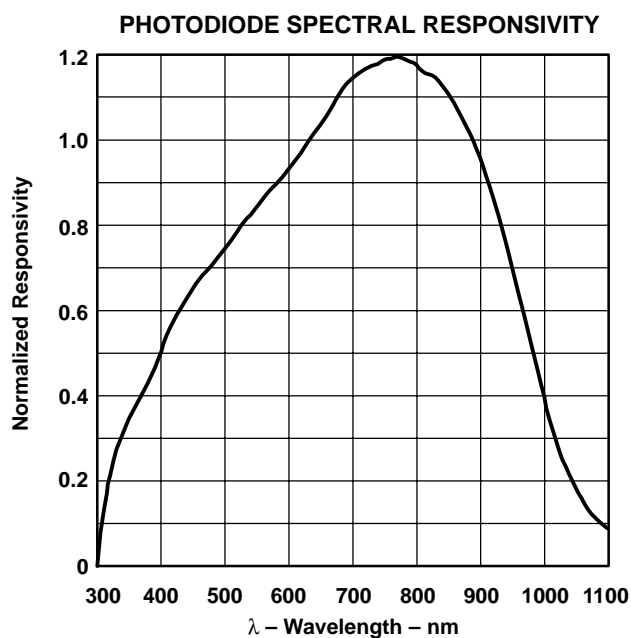

Figure 2

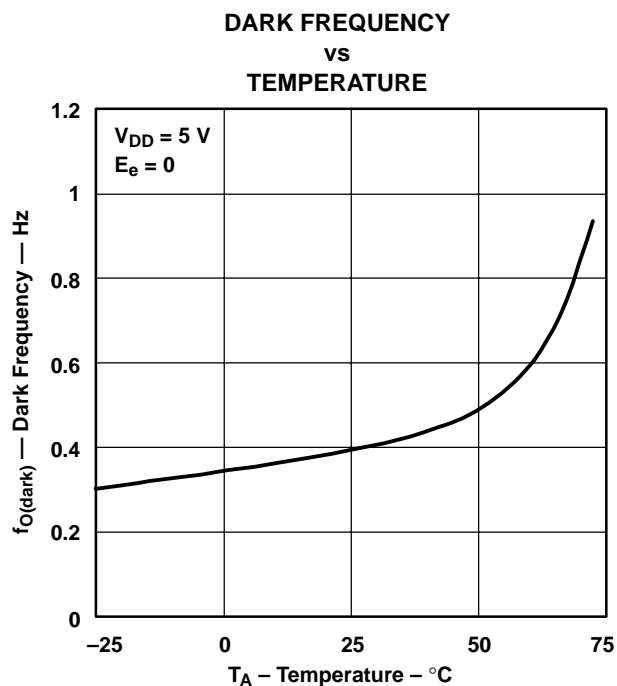

Figure 3

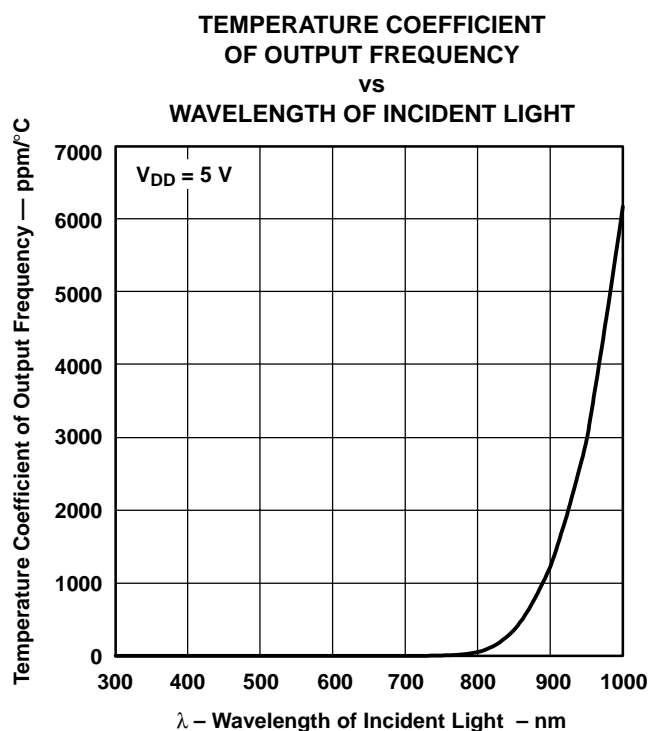

Figure 4

# TSL235R LIGHT-TO-FREQUENCY CONVERTER

TAOS038 – APRIL 2002

## TYPICAL CHARACTERISTICS

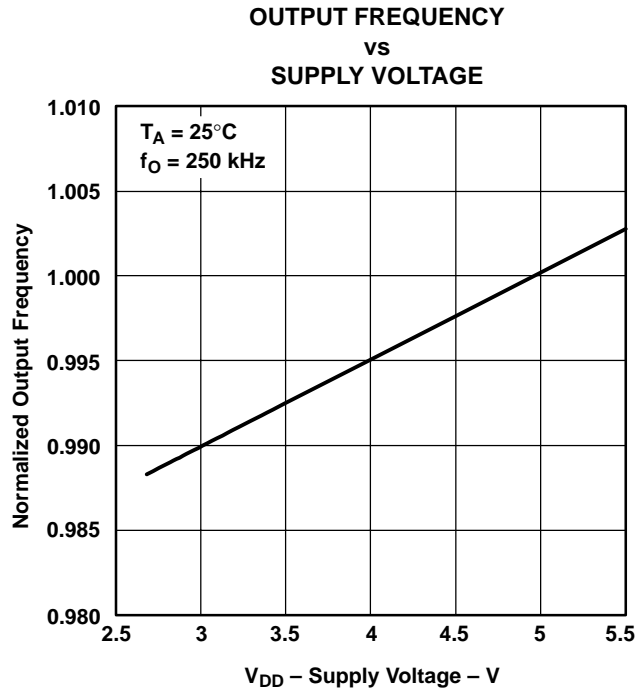

Figure 5

## APPLICATION INFORMATION

### Power-supply considerations

Power-supply lines must be decoupled by a 0.01- $\mu$ F to 0.1- $\mu$ F capacitor with short leads placed close to the TSL235R (Figure 6).

### Output interface

The output of the device is designed to drive a standard TTL or CMOS logic input over short distances. If lines greater than 12 inches are used on the output, a buffer or line driver is recommended.

### Measuring the frequency

The choice of interface and measurement technique depends on the desired resolution and data-acquisition rate. For maximum data-acquisition rate, period-measurement techniques are used.

Period measurement requires the use of a fast reference clock with available resolution directly related to reference-clock rate. The technique is employed to measure rapidly varying light levels or to make a fast measurement of a constant light source.

Maximum resolution and accuracy may be obtained using frequency-measurement, pulse-accumulation, or integration techniques. Frequency measurements provide the added benefit of averaging out random- or high-frequency variations (jitter) resulting from noise in the light signal. Resolution is limited mainly by available counter registers and allowable measurement time. Frequency measurement is well suited for slowly varying or constant light levels and for reading average light levels over short periods of time. Integration, the accumulation of pulses over a very long period of time, can be used to measure exposure — the amount of light present in an area over a given time period.

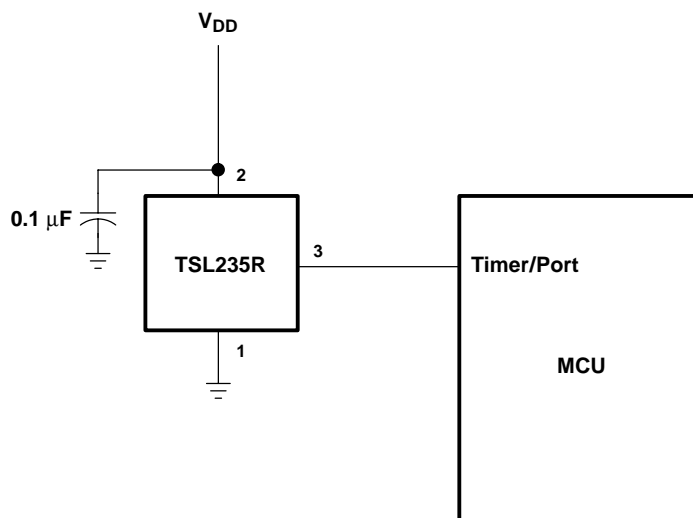

**Figure 6. Typical TSL235R Interface to a Microcontroller**

# TSL235R LIGHT-TO-FREQUENCY CONVERTER

TAOS038 – APRIL 2002

## MECHANICAL DATA

The device is supplied in a clear plastic three-lead package.

### PLASTIC SINGLE-IN-LINE PACKAGE

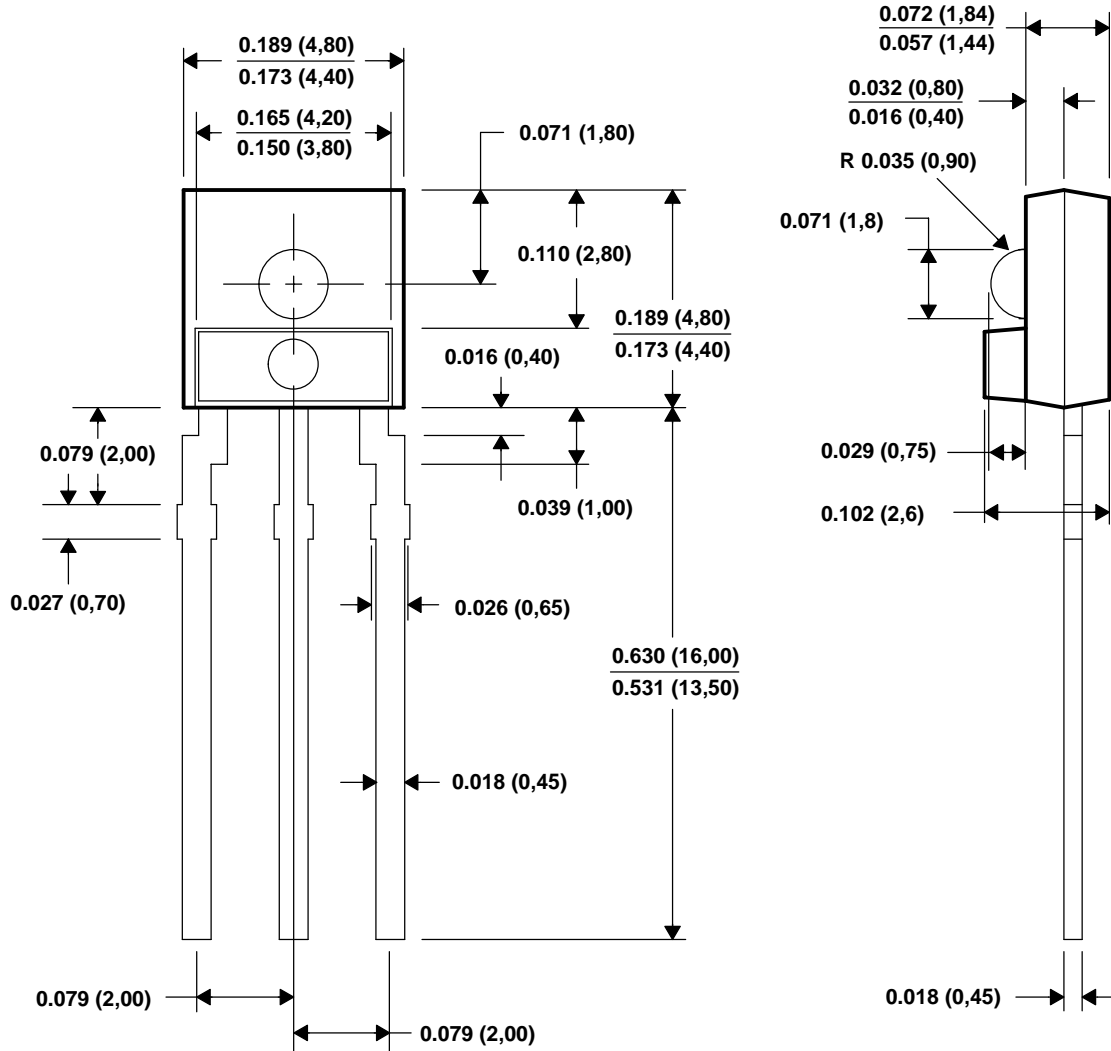

Figure 7. Package Configuration

- NOTES:
- All linear dimensions are in inches (millimeters).
  - This drawing is subject to change without notice.
  - All dimensions apply before solder dip.
  - Package body is a clear nonfilled optically transparent material
  - Index of refraction of clear plastic is 1.55.

**PRODUCTION DATA** — information in this document is current at publication date. Products conform to specifications in accordance with the terms of Texas Advanced Optoelectronic Solutions, Inc. standard warranty. Production processing does not necessarily include testing of all parameters.

**NOTICE**

Texas Advanced Optoelectronic Solutions, Inc. (TAOS) reserves the right to make changes to the products contained in this document to improve performance or for any other purpose, or to discontinue them without notice. Customers are advised to contact TAOS to obtain the latest product information before placing orders or designing TAOS products into systems.

TAOS assumes no responsibility for the use of any products or circuits described in this document or customer product design, conveys no license, either expressed or implied, under any patent or other right, and makes no representation that the circuits are free of patent infringement. TAOS further makes no claim as to the suitability of its products for any particular purpose, nor does TAOS assume any liability arising out of the use of any product or circuit, and specifically disclaims any and all liability, including without limitation consequential or incidental damages.

TEXAS ADVANCED OPTOELECTRONIC SOLUTIONS, INC. PRODUCTS ARE NOT DESIGNED OR INTENDED FOR USE IN CRITICAL APPLICATIONS IN WHICH THE FAILURE OR MALFUNCTION OF THE TAOS PRODUCT MAY RESULT IN PERSONAL INJURY OR DEATH. USE OF TAOS PRODUCTS IN LIFE SUPPORT SYSTEMS IS EXPRESSLY UNAUTHORIZED AND ANY SUCH USE BY A CUSTOMER IS COMPLETELY AT THE CUSTOMER'S RISK.

LUMENOLOGY is a registered trademark, and TAOS, the TAOS logo, and Texas Advanced Optoelectronic Solutions are trademarks of Texas Advanced Optoelectronic Solutions Incorporated.

# TSL235R LIGHT-TO-FREQUENCY CONVERTER

TAOS038 – APRIL 2002

---