

6A HIGH-SPEED MOSFET DRIVERS

FEATURES

- Latch-Up Protected Will Withstand > 1.5A Reverse Output Current
- Logic Input Will Withstand Negative Swing Up to 5V
- ESD Protected 4kV
- Matched Rise and Fall Times 25nsec
- High Peak Output Current 6A Peak
- Wide Operating Range 4.5V to 18V
- High Capacitive Load Drive 10,000 pF
- Short Delay Time 55nsec Typ
- Logic High Input, Any Voltage 2.4V to V_{DD}
- Low Supply Current With Logic "1" Input ... 450 μ A
- Low Output Impedance 2.5 Ω
- Output Voltage Swing to Within 25mV of Ground or V_{DD}

APPLICATIONS

- Switch-Mode Power Supplies
- Motor Controls
- Pulse Transformer Driver
- Class D Switching Amplifiers

FUNCTIONAL BLOCK DIAGRAM

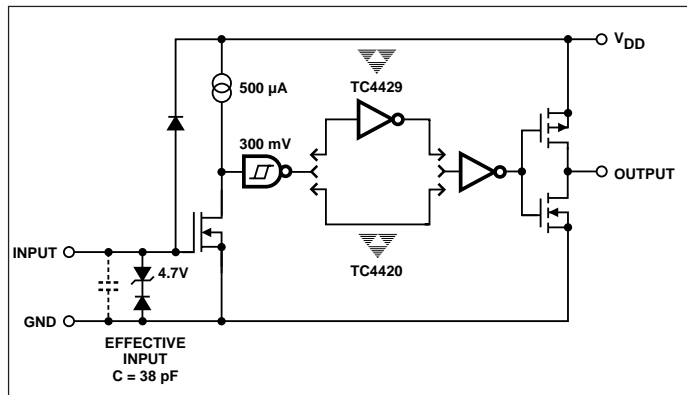

PIN CONFIGURATIONS

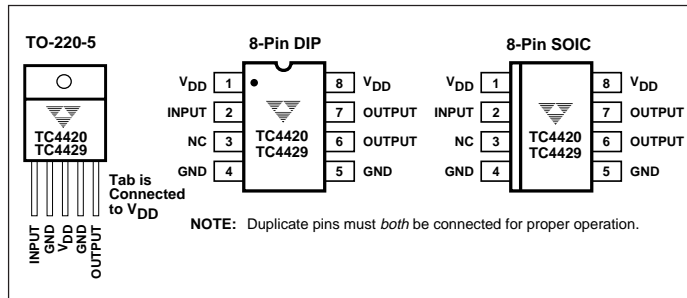

GENERAL DESCRIPTION

The TC4420/4429 are 6A (peak), single output MOSFET drivers. The TC4429 is an inverting driver (pin-compatible with the TC429), while the TC4420 is a non-inverting driver. These drivers are fabricated in CMOS for lower power, more efficient operation versus bipolar drivers.

Both devices have TTL-compatible inputs, which can be driven as high as $V_{DD} + 0.3V$ or as low as $-5V$ without upset or damage to the device. This eliminates the need for external level shifting circuitry and its associated cost and size. The output swing is rail-to-rail ensuring better drive voltage margin, especially during power up/power down sequencing. Propagational delay time is only 55nsec (typ.) and the output rise and fall times are only 25nsec (typ.) into 2500pF across the usable power supply range.

Unlike other drivers, the TC4420/4429 are virtually latch-up proof. They replace three or more discrete components saving PCB area, parts and improving overall system reliability.

ORDERING INFORMATION

| Part No. | Logic | Package | Temp. Range |
|-----------|--------------|--------------|-----------------|
| TC4420CAT | Noninverting | 5-Pin TO-220 | 0°C to +70°C |
| TC4420COA | Noninverting | 8-Pin SOIC | 0°C to +70°C |
| TC4420CPA | Noninverting | 8-Pin PDIP | 0°C to +70°C |
| TC4420EOA | Noninverting | 8-Pin SOIC | -40°C to +85°C |
| TC4420EPA | Noninverting | 8-Pin PDIP | -40°C to +85°C |
| TC4420IJA | Noninverting | 8-Pin CerDIP | -25°C to +85°C |
| TC4420MJA | Noninverting | 8-Pin CerDIP | -55°C to +125°C |
| TC4429CAT | Inverting | 5-Pin TO-220 | 0°C to +70°C |
| TC4429COA | Inverting | 8-Pin SOIC | 0°C to +70°C |
| TC4429CPA | Inverting | 8-Pin PDIP | 0°C to +70°C |
| TC4429EOA | Inverting | 8-Pin SOIC | -40°C to +85°C |
| TC4429EPA | Inverting | 8-Pin PDIP | -40°C to +85°C |
| TC4429IJA | Inverting | 8-Pin CerDIP | -25°C to +85°C |
| TC4429MJA | Inverting | 8-Pin CerDIP | -55°C to +125°C |

TC4420 TC4429

ABSOLUTE MAXIMUM RATINGS*

| | |
|--|---------------------------|
| Supply Voltage | +20V |
| Input Voltage | - 5V to > V _{DD} |
| Input Current (V _{IN} > V _{DD}) | 50mA |
| Power Dissipation, T _A ≤ 70°C | |
| PDIP | 730mW |
| SOIC | 470mW |
| CerDIP | 800mW |
| 5-Pin TO-220 | 1.6W |
| Package Power Dissipation (T _A ≤ 70°C) | |
| 5-Pin TO-220 (With Heat Sink) | 1.60W |
| Derating Factors (To Ambient) | |
| PDIP | 8mW/°C |
| SOIC | 4mW/°C |
| CerDIP | 6.4mW/°C |
| 5-Pin TO-220 | 12mW/°C |
| Thermal Impedances (To Case) | |
| 5-Pin TO-220 R _{θJ-C} | 10°C/W |

| | |
|--|------------------|
| Storage Temperature Range | - 65°C to +150°C |
| Operating Temperature (Chip) | +150°C |
| Operating Temperature Range (Ambient) | |
| C Version | 0°C to +70°C |
| I Version | - 25°C to +85°C |
| E Version | - 40°C to +85°C |
| M Version | - 55°C to +125°C |
| Lead Temperature (Soldering, 10 sec) | +300°C |

*Static-sensitive device. Unused devices must be stored in conductive material. Protect devices from static discharge and static fields. Stresses above those listed under "Absolute Maximum Ratings" may cause permanent damage to the device. These are stress ratings only and functional operation of the device at these or any other conditions above those indicated in the operation sections of the specifications is not implied. Exposure to absolute maximum rating conditions for extended periods may affect device reliability.

ELECTRICAL CHARACTERISTICS: T_A = +25°C with 4.5V ≤ V_{DD} ≤ 18V, unless otherwise specified.

| Symbol | Parameter | Test Conditions | Min | Typ | Max | Unit |
|--------------------------------|--|---|-------------------------|------------|----------------------|----------|
| Input | | | | | | |
| V _{IH} | Logic 1 High Input Voltage | | 2.4 | 1.8 | — | V |
| V _{IL} | Logic 0 Low Input Voltage | | — | 1.3 | 0.8 | V |
| V _{IN (Max)} | Input Voltage Range | | -5 | — | V _{DD} +0.3 | V |
| I _{IN} | Input Current | 0V ≤ V _{IN} ≤ V _{DD} | - 10 | — | 10 | μA |
| Output | | | | | | |
| V _{OH} | High Output Voltage | See Figure 1 | V _{DD} - 0.025 | — | — | V |
| V _{OL} | Low Output Voltage | See Figure 1 | — | — | 0.025 | V |
| R _O | Output Resistance, High | I _{OUT} = 10 mA, V _{DD} = 18V | — | 2.1 | 2.8 | Ω |
| R _O | Output Resistance, Low | I _{OUT} = 10 mA, V _{DD} = 18V | — | 1.5 | 2.5 | Ω |
| I _{PK} | Peak Output Current | V _{DD} = 18V (See Figure 5) | — | 6 | — | A |
| I _{REV} | Latch-Up Protection Withstand Reverse Current | Duty Cycle ≤ 2% t ≤ 300 μs | 1.5 | — | — | A |
| Switching Time (Note 1) | | | | | | |
| t _R | Rise Time | Figure 1, C _L = 2500 pF | — | 25 | 35 | nsec |
| t _F | Fall Time | Figure 1, C _L = 2500 pF | — | 25 | 35 | nsec |
| t _{D1} | Delay Time | Figure 1 | — | 55 | 75 | nsec |
| t _{D2} | Delay Time | Figure 1 | — | 55 | 75 | nsec |
| Power Supply | | | | | | |
| I _S | Power Supply Current | V _{IN} = 3V V _{IN} = 0V | — | 0.45 55 | 1.5 150 | mA μA |
| V _{DD} | Operating Input Voltage | | 4.5 | — | 18 | V |

ELECTRICAL CHARACTERISTICS: Measured over operating temperature range with $4.5V \leq V_{DD} \leq 18V$, unless otherwise specified.

| Symbol | Parameter | Test Conditions | Min | Typ | Max | Unit |
|--------------------------------|----------------------------|---|------------------|------------|----------------|------------------------|
| Input | | | | | | |
| V_{IH} | Logic 1 High Input Voltage | | 2.4 | — | — | V |
| V_{IL} | Logic 0 Low Input Voltage | | — | — | 0.8 | V |
| $V_{IN} (Max)$ | Input Voltage Range | | -5 | — | $V_{DD} + 0.3$ | V |
| I_{IN} | Input Current | $0V \leq V_{IN} \leq V_{DD}$ | -10 | — | 10 | μA |
| Output | | | | | | |
| V_{OH} | High Output Voltage | See Figure 1 | $V_{DD} - 0.025$ | — | — | V |
| V_{OL} | Low Output Voltage | See Figure 1 | — | — | 0.025 | V |
| R_O | Output Resistance, High | $I_{OUT} = 10 \text{ mA}, V_{DD} = 18V$ | — | 3 | 5 | Ω |
| R_O | Output Resistance, Low | $I_{OUT} = 10 \text{ mA}, V_{DD} = 18V$ | — | 2.3 | 5 | Ω |
| Switching Time (Note 1) | | | | | | |
| t_R | Rise Time | Figure 1, $C_L = 2500 \text{ pF}$ | — | 32 | 60 | nsec |
| t_F | Fall Time | Figure 1, $C_L = 2500 \text{ pF}$ | — | 34 | 60 | nsec |
| t_{D1} | Delay Time | Figure 1 | — | 50 | 100 | nsec |
| t_{D2} | Delay Time | Figure 1 | — | 65 | 100 | nsec |
| Power Supply | | | | | | |
| I_S | Power Supply Current | $V_{IN} = 3V$ $V_{IN} = 0V$ | — | 0.45 60 | 3 400 | mA μA |
| V_{DD} | Operating Input Voltage | | 4.5 | — | 18 | V |

NOTE: 1. Switching times guaranteed by design.

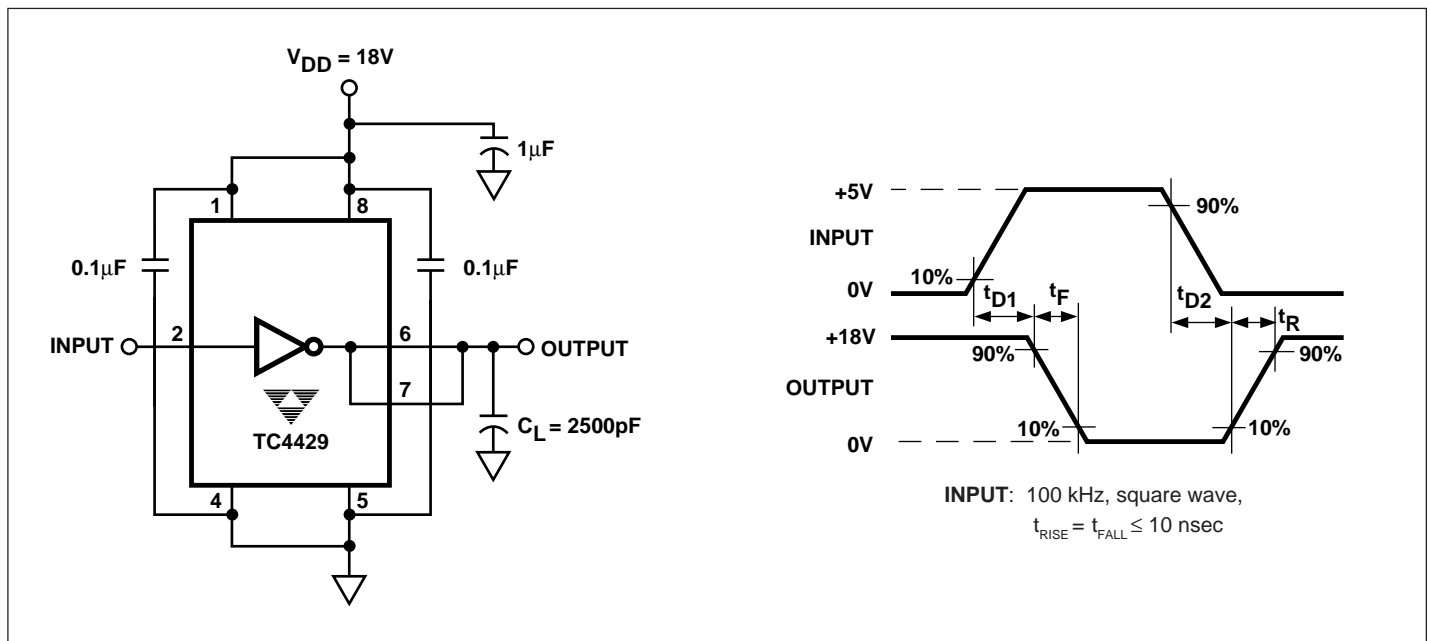
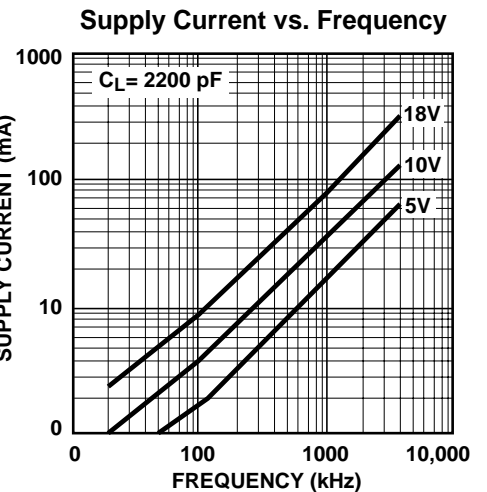
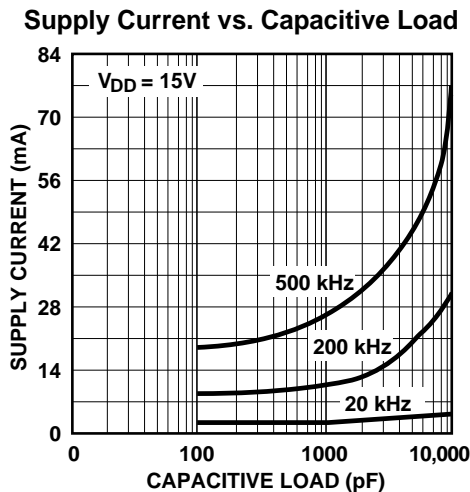
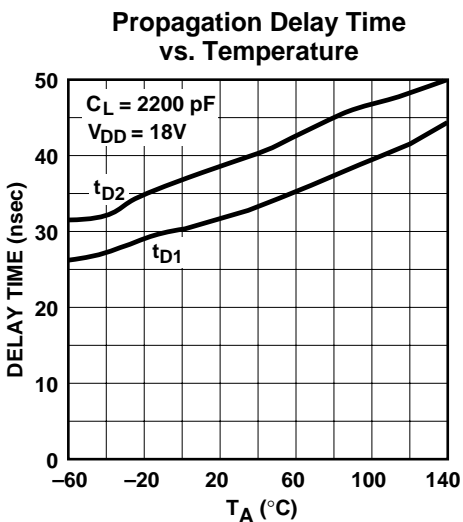
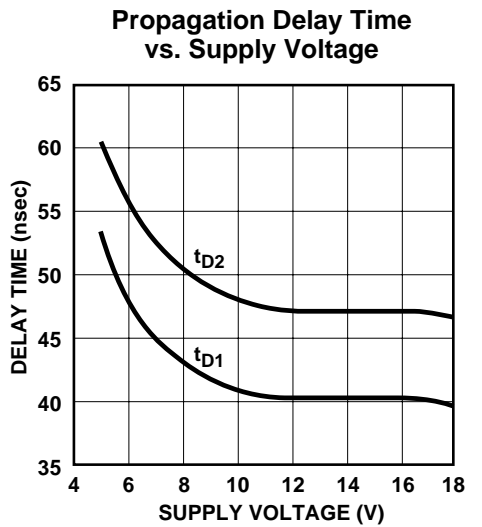
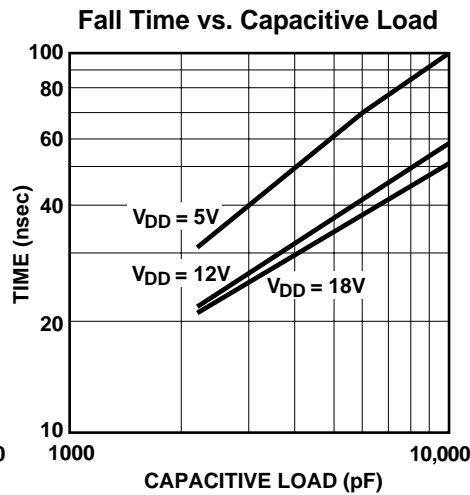
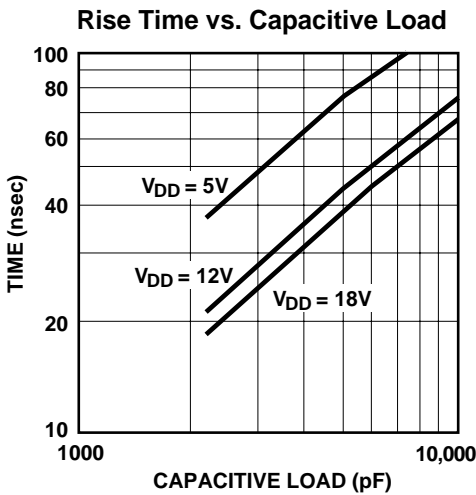
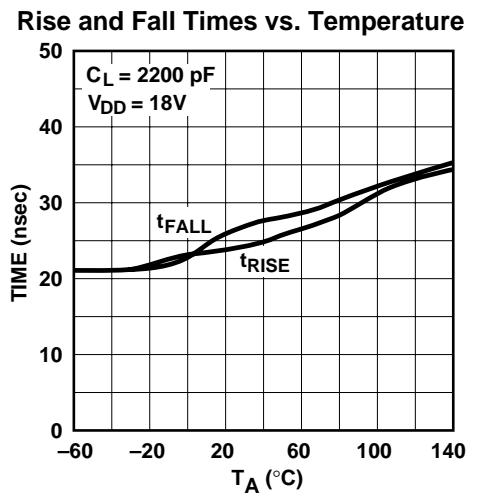
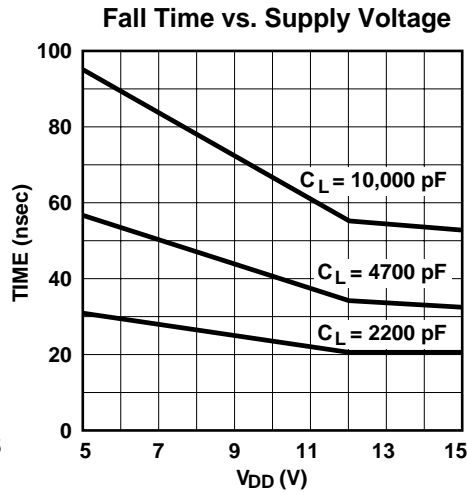
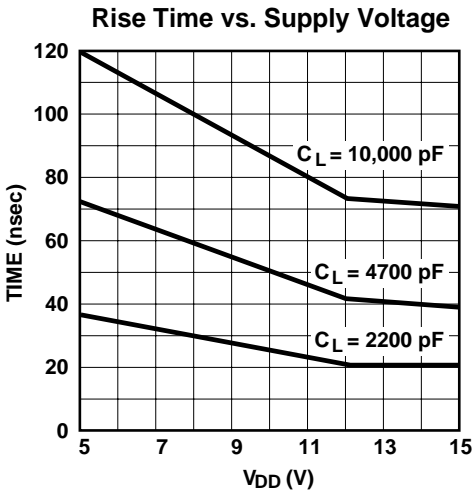

Figure 1. Switching Time Test Circuit

TC4420
TC4429

TYPICAL CHARACTERISTICS



1.5A DUAL OPEN-DRAIN MOSFET DRIVERS

TC4420
TC4429

TYPICAL CHARACTERISTICS (Cont.)

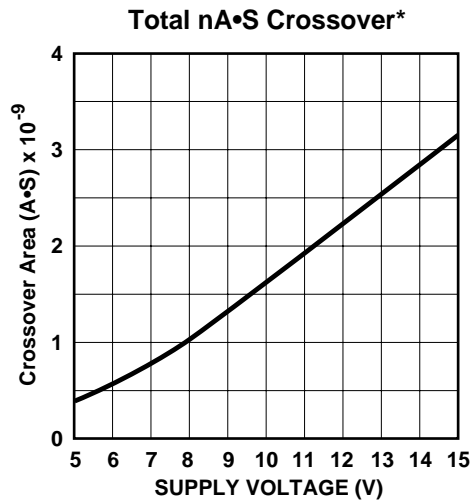
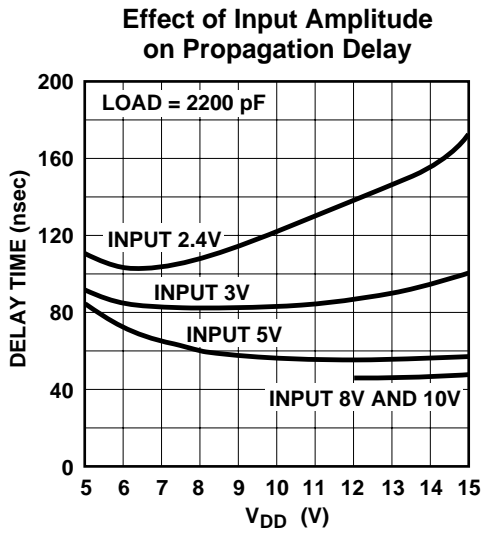
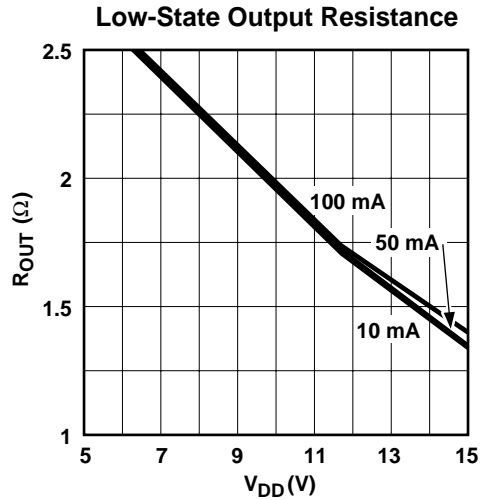
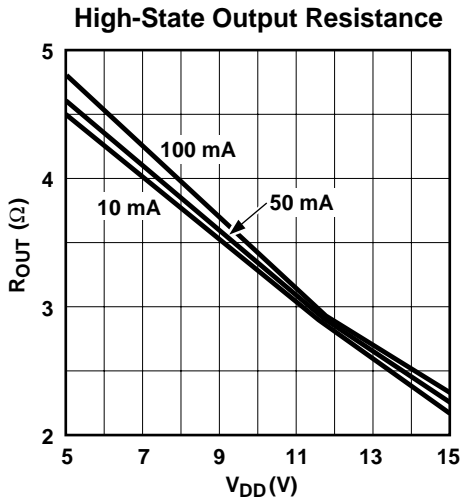

* The values on this graph represent the loss seen by the driver during one complete cycle. For a single transition, divide the value by 2.

4