

- Designed for Complementary Use with the BD245 Series
- 80 W at 25°C Case Temperature
- 10 A Continuous Collector Current
- 15 A Peak Collector Current
- Customer-Specified Selections Available

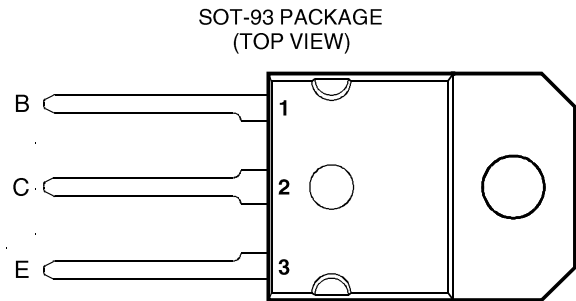

Pin 2 is in electrical contact with the mounting base.

MDTRAA

absolute maximum ratings at 25°C case temperature (unless otherwise noted)

RATING		SYMBOL	VALUE	UNIT
Collector-emitter voltage ( $R_{BE} = 100 \Omega$ )	BD246	$V_{CER}$	-55	V
	BD246A		-70	
	BD246B		-90	
	BD246C		-115	
Collector-emitter voltage ( $I_C = -30 \text{ mA}$ )	BD246	$V_{CEO}$	-45	V
	BD246A		-60	
	BD246B		-80	
	BD246C		-100	
Emitter-base voltage		$V_{EBO}$	-5	V
Continuous collector current		$I_C$	-10	A
Peak collector current (see Note 1)		$I_{CM}$	-15	A
Continuous base current		$I_B$	-3	A
Continuous device dissipation at (or below) 25°C case temperature (see Note 2)		$P_{tot}$	80	W
Continuous device dissipation at (or below) 25°C free air temperature (see Note 3)		$P_{tot}$	3	W
Unclamped inductive load energy (see Note 4)		$\frac{1}{2}LI_C^2$	62.5	mJ
Operating junction temperature range		$T_j$	-65 to +150	°C
Storage temperature range		$T_{stg}$	-65 to +150	°C
Lead temperature 3.2 mm from case for 10 seconds		$T_L$	250	°C

- NOTES: 1. This value applies for  $t_p \leq 0.3 \text{ ms}$ , duty cycle  $\leq 10\%$ .  
 2. Derate linearly to 150°C case temperature at the rate of 0.64 W/°C.  
 3. Derate linearly to 150°C free air temperature at the rate of 24 mW/°C.  
 4. This rating is based on the capability of the transistor to operate safely in a circuit of:  $L = 20 \text{ mH}$ ,  $I_{B(on)} = -0.4 \text{ A}$ ,  $R_{BE} = 100 \Omega$ ,  $V_{BE(off)} = 0$ ,  $R_S = 0.1 \Omega$ ,  $V_{CC} = -20 \text{ V}$ .

# BD246, BD246A, BD246B, BD246C

## PNP SILICON POWER TRANSISTORS

### electrical characteristics at 25°C case temperature

PARAMETER	TEST CONDITIONS			MIN	TYP	MAX	UNIT
$V_{(BR)CEO}$ Collector-emitter breakdown voltage	$I_C = -30 \text{ mA}$ (see Note 5)	$I_B = 0$	BD246 BD246A BD246B BD246C	-45 -60 -80 -100			V
$I_{CES}$ Collector-emitter cut-off current	$V_{CE} = -55 \text{ V}$ $V_{CE} = -70 \text{ V}$ $V_{CE} = -90 \text{ V}$ $V_{CE} = -115 \text{ V}$	$V_{BE} = 0$ $V_{BE} = 0$ $V_{BE} = 0$ $V_{BE} = 0$	BD246 BD246A BD246B BD246C			-0.4 -0.4 -0.4 -0.4	mA
$I_{CEO}$ Collector cut-off current	$V_{CE} = -30 \text{ V}$ $V_{CE} = -60 \text{ V}$	$I_B = 0$ $I_B = 0$	BD246/246A BD246B/246C			-0.7 -0.7	mA
$I_{EBO}$ Emitter cut-off current	$V_{EB} = -5 \text{ V}$	$I_C = 0$				-1	mA
$h_{FE}$ Forward current transfer ratio	$V_{CE} = -4 \text{ V}$ $V_{CE} = -4 \text{ V}$ $V_{CE} = -4 \text{ V}$	$I_C = -1 \text{ A}$ $I_C = -3 \text{ A}$ $I_C = -10 \text{ A}$	(see Notes 5 and 6)	40 20 4			
$V_{CE(sat)}$ Collector-emitter saturation voltage	$I_B = -0.3 \text{ A}$ $I_B = -2.5 \text{ A}$	$I_C = -3 \text{ A}$ $I_C = -10 \text{ A}$	(see Notes 5 and 6)			-1 -4	V
$V_{BE}$ Base-emitter voltage	$V_{CE} = -4 \text{ V}$ $V_{CE} = -4 \text{ V}$	$I_C = -3 \text{ A}$ $I_C = -10 \text{ A}$	(see Notes 5 and 6)			-1.6 -3	V
$h_{fe}$ Small signal forward current transfer ratio	$V_{CE} = -10 \text{ V}$	$I_C = -0.5 \text{ A}$	$f = 1 \text{ kHz}$	20			
$ h_{fe} $ Small signal forward current transfer ratio	$V_{CE} = -10 \text{ V}$	$I_C = -0.5 \text{ A}$	$f = 1 \text{ MHz}$	3			

NOTES: 5. These parameters must be measured using pulse techniques,  $t_p = 300 \mu\text{s}$ , duty cycle  $\leq 2\%$ .

6. These parameters must be measured using voltage-sensing contacts, separate from the current carrying contacts.

### thermal characteristics

PARAMETER	MIN	TYP	MAX	UNIT
$R_{\theta JC}$ Junction to case thermal resistance			1.56	°C/W
$R_{\theta JA}$ Junction to free air thermal resistance			42	°C/W

### resistive-load-switching characteristics at 25°C case temperature

PARAMETER	TEST CONDITIONS †			MIN	TYP	MAX	UNIT
$t_{on}$ Turn-on time	$I_C = -1 \text{ A}$	$I_{B(on)} = -0.1 \text{ A}$	$I_{B(off)} = 0.1 \text{ A}$		0.2		$\mu\text{s}$
$t_{off}$ Turn-off time	$V_{BE(off)} = 3.7 \text{ V}$	$R_L = 20 \Omega$	$t_p = 20 \mu\text{s}$ , dc $\leq 2\%$		0.8		$\mu\text{s}$

† Voltage and current values shown are nominal; exact values vary slightly with transistor parameters.

TYPICAL CHARACTERISTICS

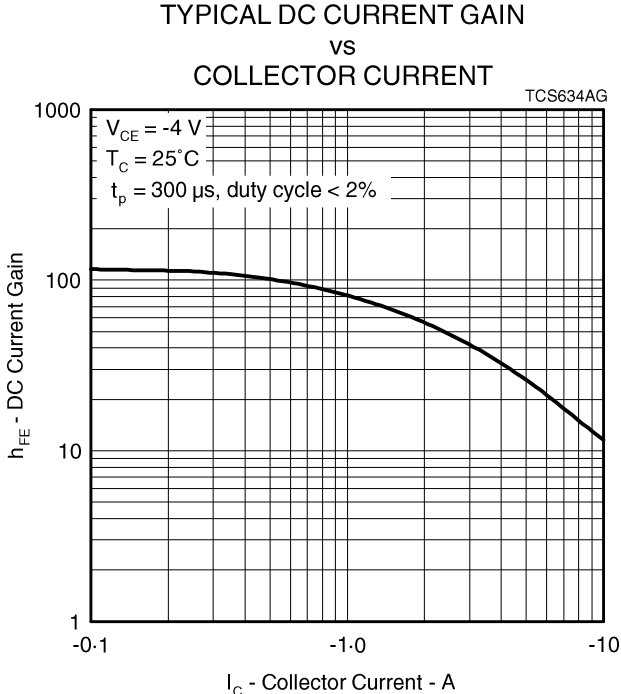

Figure 1.

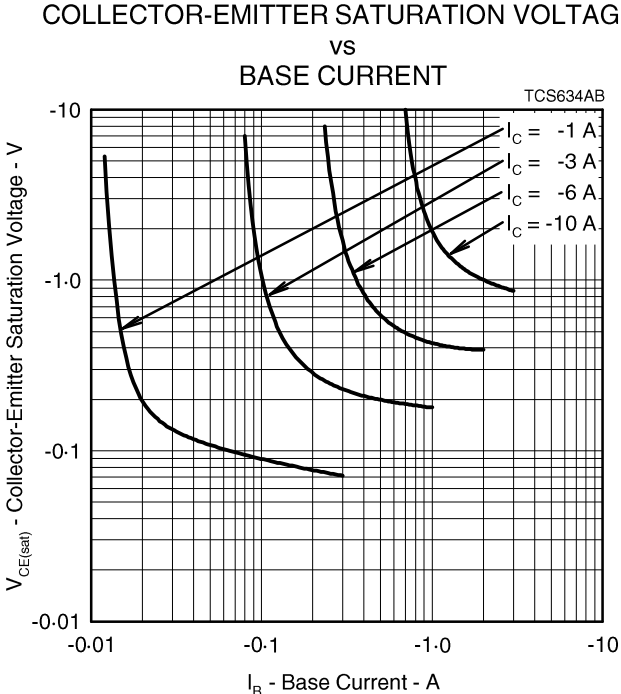

Figure 2.

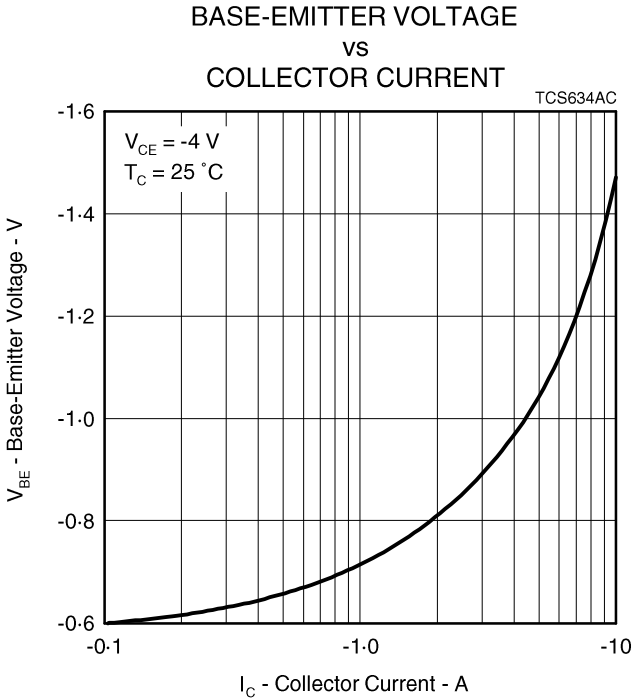

Figure 3.

# BD246, BD246A, BD246B, BD246C PNP SILICON POWER TRANSISTORS

## MAXIMUM SAFE OPERATING REGIONS

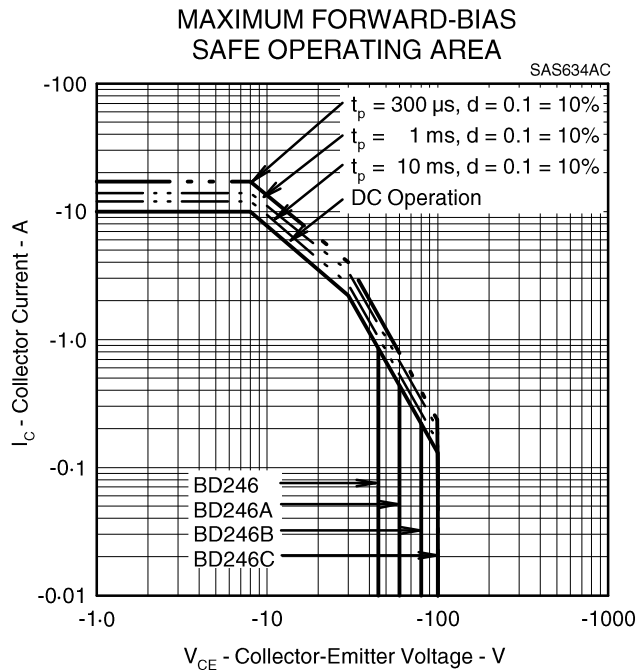

Figure 4.

## THERMAL INFORMATION

### MAXIMUM POWER DISSIPATION vs CASE TEMPERATURE

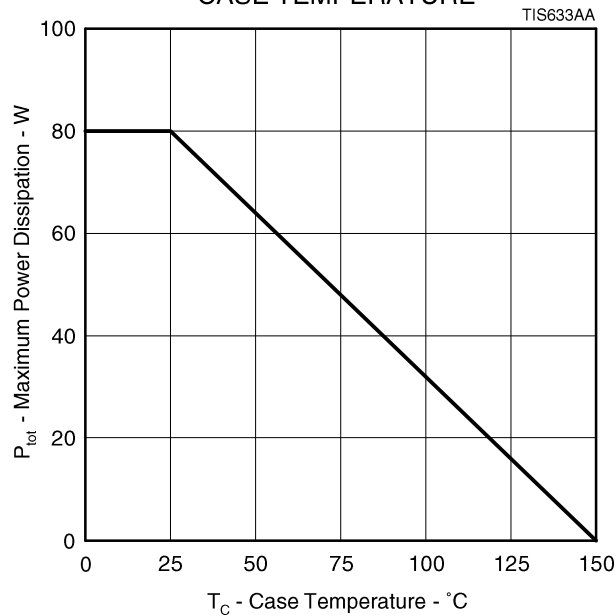

Figure 5.

MECHANICAL DATA

SOT-93

3-pin plastic flange-mount package

This single-in-line package consists of a circuit mounted on a lead frame and encapsulated within a plastic compound. The compound will withstand soldering temperature with no deformation, and circuit performance characteristics will remain stable when operated in high humidity conditions. Leads require no additional cleaning or processing when used in soldered assembly.

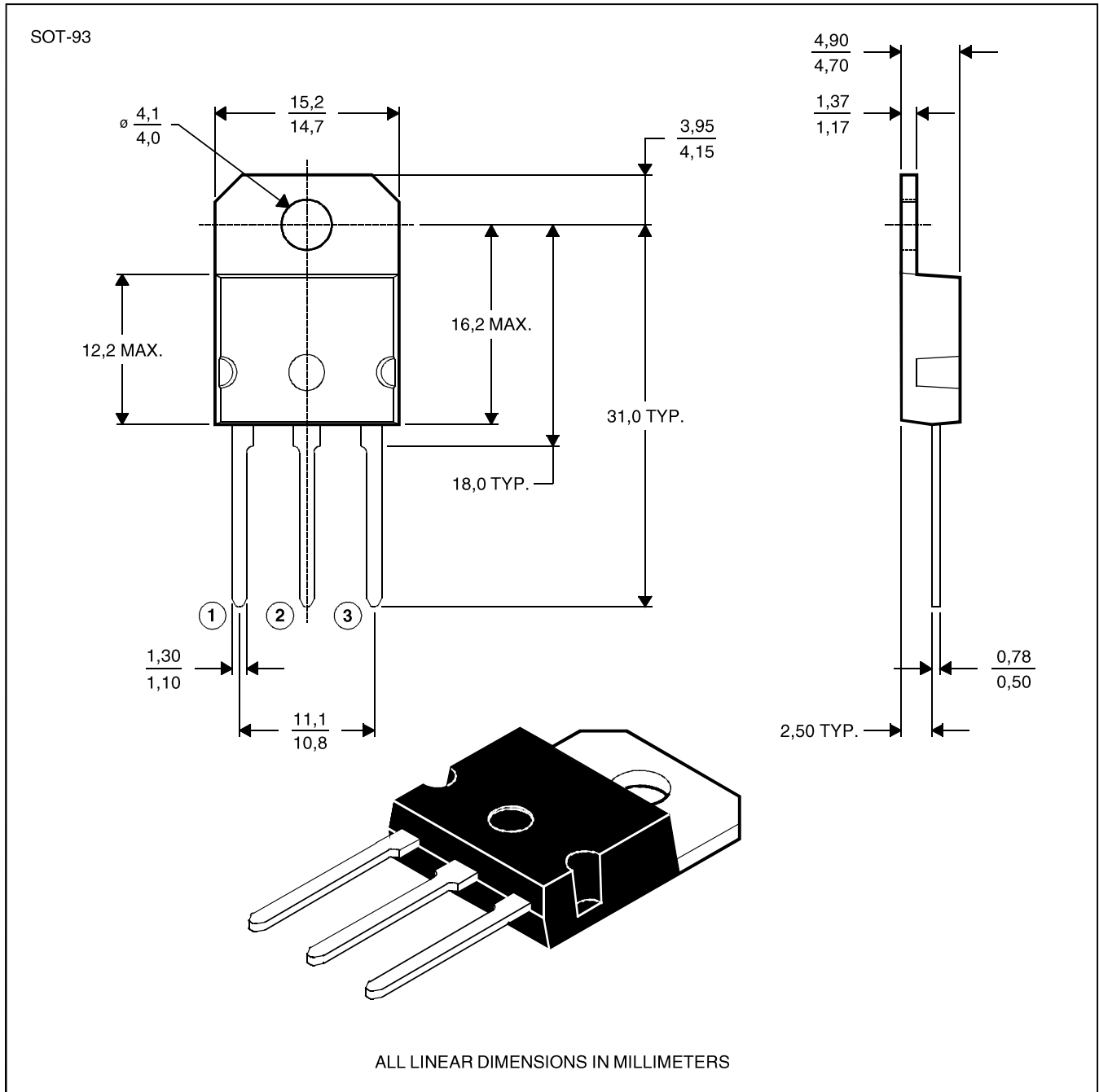

NOTE A: The centre pin is in electrical contact with the mounting tab.