

GS1A THRU GS1M

SURFACE MOUNT RECTIFIER

VOLTAGE - 50 to 1000 Volts CURRENT - 1.0 Ampere

FEATURES

- For surface mounted applications
- Low profile package
- Built-in strain relief
- Easy pick and place
- Plastic package has Underwriters Laboratory

Flammability Classification 94V-O

- Glass passivated chip junction
- High temperature soldering:
260 /10 seconds at terminals

SMA/DO-214AC

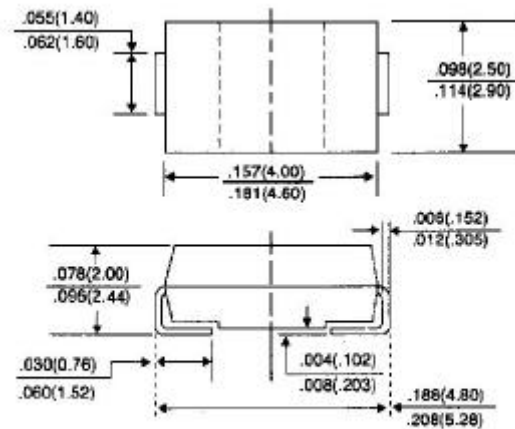

Dimensions in inches and (millimeters)

MECHANICAL DATA

Case: JEDEC DO-214AC molded plastic

Terminals: Solder plated, solderable per MIL-STD-750,
Method 2026

Polarity: Indicated by cathode band

Standard packaging: 12mm tape (EIA-481)

Weight: 0.002 ounce, 0.064 gram

MAXIMUM RATINGS AND ELECTRICAL CHARACTERISTICS

Ratings at 25 ambient temperature unless otherwise specified.

Single phase, half wave, 60 Hz, resistive or inductive load.

For capacitive load, derate current by 20%.

	SYMBOLS	GS1A	GS1B	GS1D	GS1G	GS1J	GS1K	GS1M	UNITS
Maximum Recurrent Peak Reverse Voltage	V_{RRM}	50	100	200	400	600	800	1000	Volts
Maximum RMS Voltage	V_{RMS}	35	70	140	280	420	560	700	Volts
Maximum DC Blocking Voltage	V_{DC}	50	100	200	400	600	800	1000	Volts
Maximum Average Forward Rectified Current, at $T_L=100$	$I_{(AV)}$	1.0							Amps
Peak Forward Surge Current 8.3ms single half sine-wave superimposed on rated load(JEDEC method)	I_{FSM}	30.0							Amps
Maximum Instantaneous Forward Voltage at 1.0A	V_F	1.10							Volts
Maximum DC Reverse Current $T_A=25$ At Rated DC Blocking Voltage $T_A=125$	I_R	5.0 50							A
Maximum Reverse Recovery Time (Note 1)	T_{RR}	2.5							S
Typical Junction capacitance (Note 2)	C_J	12							pF
Typical Thermal Resistance (Note 3)	R_{JL}	30.0							/W
Operating and Storage Temperature Range	T_J, T_{STG}	-55 to +150							

NOTES:

1. Reverse Recovery Test Conditions: $I_F=0.5A$, $I_R=1.0A$, $I_{rr}=0.25A$
2. Measured at 1.0 MHz and Applied $V_r=4.0$ volts

3. 8.0mm² (.013mm thick) land areas
 RATING AND CHARACTERISTIC CURVES
 GS1A THRU GS1M

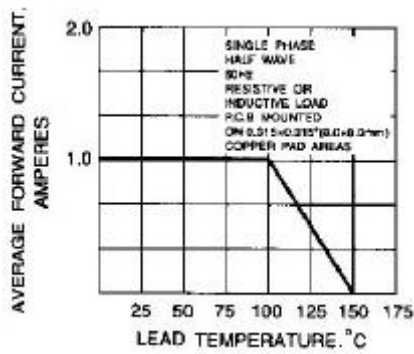

Fig. 1-FORWARD CURRENT DERATING CURVE

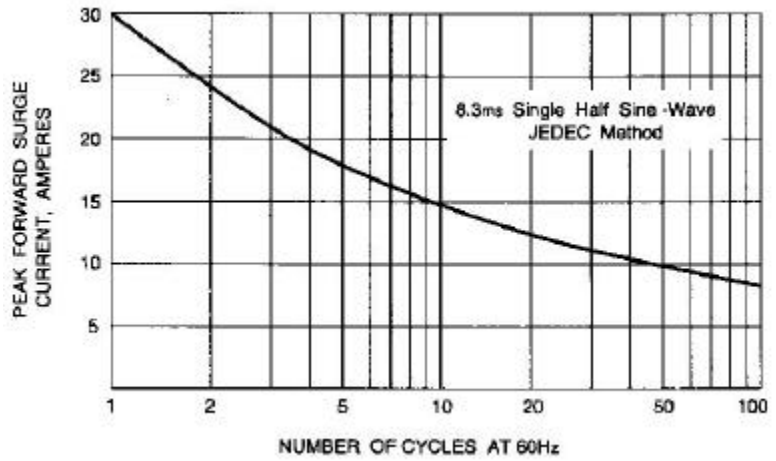

Fig. 2-MAXIMUM NON-REPETITIVE PEAK FORWARD SURGE CURRENT

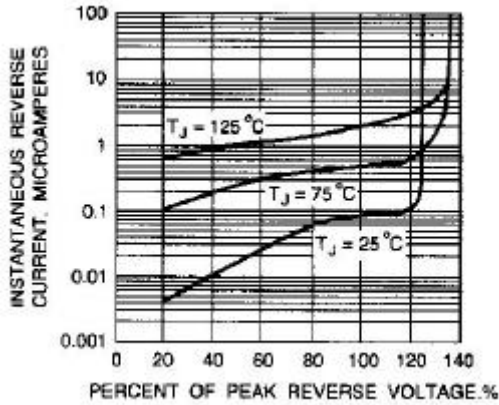

Fig. 3-TYPICAL REVERSE CHARACTERISTICS

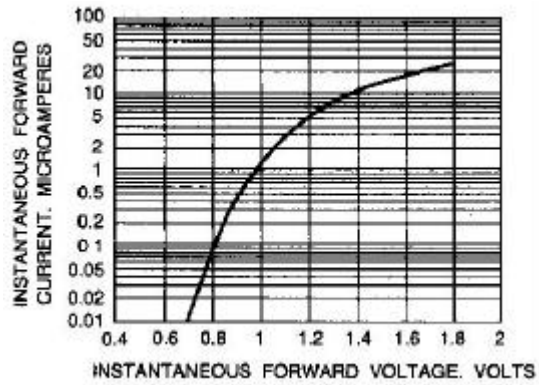

Fig. 4-TYPICAL INSTANTANEOUS FORWARD CHARACTERISTICS

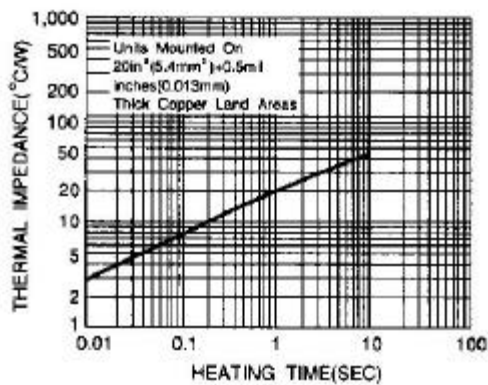

Fig. 5-TRANSIENT THERMAL IMPEDANCE

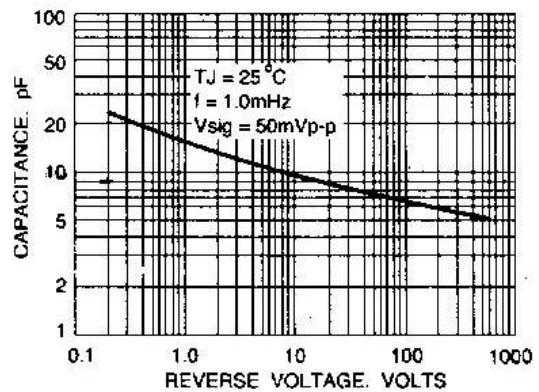

Fig. 6-TYPICAL JUNCTION CAPACITANCE