

- Rugged Epitaxial Planar Construction
- 10 A Continuous Collector Current
- Operating Characteristics Fully Guaranteed at 100°C
- $t_{xo}$  typically 320 ns,  $I_C = 10$  A

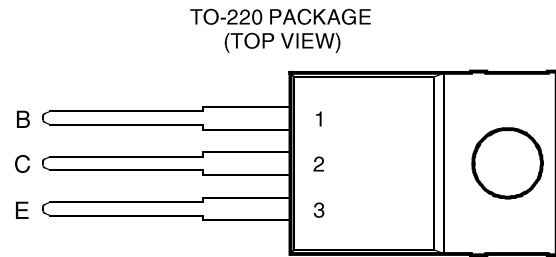

Pin 2 is in electrical contact with the mounting base.

absolute maximum ratings **at 25°C case temperature (unless otherwise noted)**

RATING		SYMBOL	VALUE	UNIT
Collector-base voltage ( $I_E = 0$ )	TIPL790	$V_{CBO}$	150	V
	TIPL790A		200	
Collector-emitter voltage ( $V_{BE} = 0$ )	TIPL790	$V_{CES}$	150	V
	TIPL790A		200	
Collector-emitter voltage ( $I_B = 0$ )	TIPL790	$V_{CEO}$	120	V
	TIPL790A		150	
Emitter-base voltage		$V_{EBO}$	8	V
Continuous collector current		$I_C$	10	A
Peak collector current (see Note 1)		$I_{CM}$	15	A
Continuous device dissipation at (or below) 25°C case temperature		$P_{tot}$	70	W
Operating junction temperature range		$T_j$	-65 to +150	°C
Storage temperature range		$T_{stg}$	-65 to +150	°C

NOTE 1: This value applies for  $t_p \leq 10$  ms, duty cycle  $\leq 2\%$ .

$t_{xo}$ Cross over time								320	500	ns
--------------------------	--	--	--	--	--	--	--	-----	-----	----

† Voltage and current values shown are nominal; exact values vary slightly with transistor parameters.

PARAMETER MEASUREMENT INFORMATION

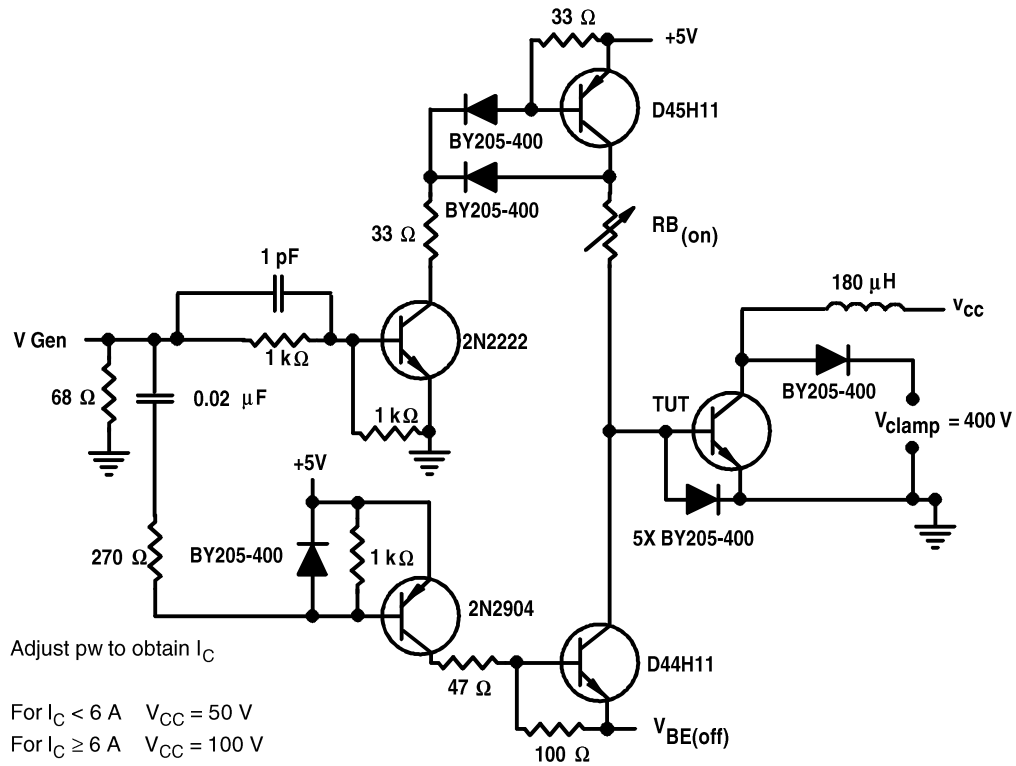
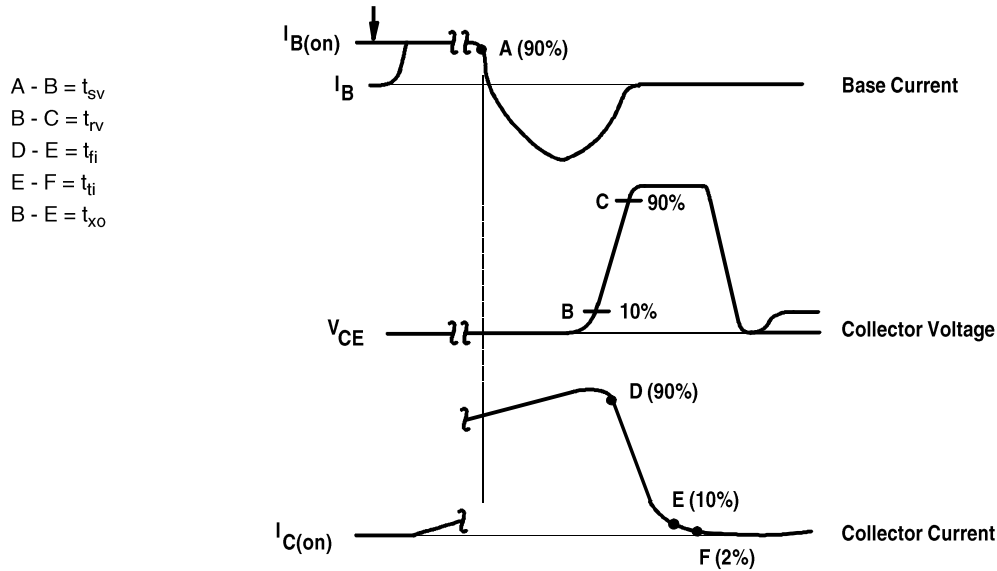

Figure 1. Inductive-Load Switching Test Circuit



NOTES: A. Waveforms are monitored on an oscilloscope with the following characteristics:  $t_r < 15 \text{ ns}$ ,  $R_{in} > 10 \Omega$ ,  $C_{in} < 11.5 \text{ pF}$ .  
B. Resistors must be noninductive types.

Figure 2. Inductive-Load Switching Waveforms

**TYPICAL CHARACTERISTICS**

TYPICAL DC CURRENT GAIN  
 VS  
 COLLECTOR CURRENT

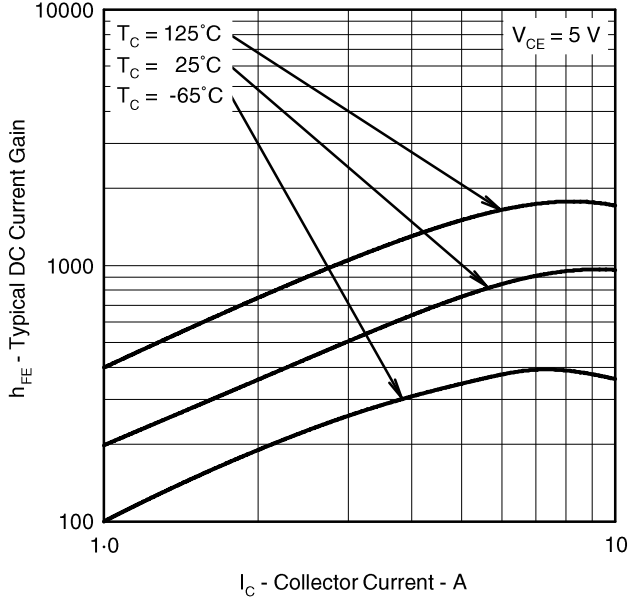

Figure 3.

COLLECTOR-EMITTER SATURATION VOLTAGE  
 VS  
 BASE CURRENT

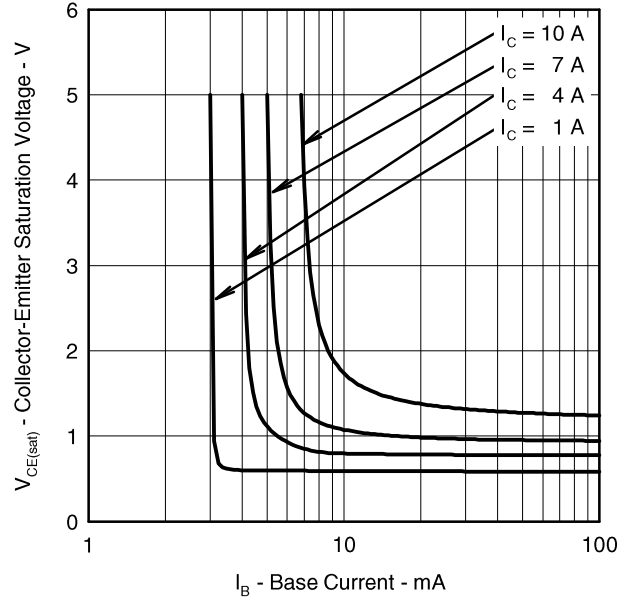

Figure 4.

BASE-EMITTER SATURATION VOLTAGE  
 VS  
 BASE CURRENT

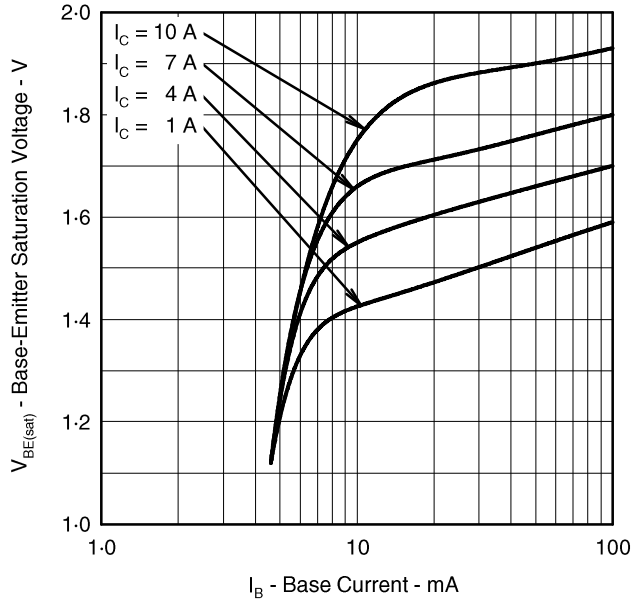

Figure 5.

COLLECTOR CUT-OFF CURRENT  
 VS  
 CASE TEMPERATURE

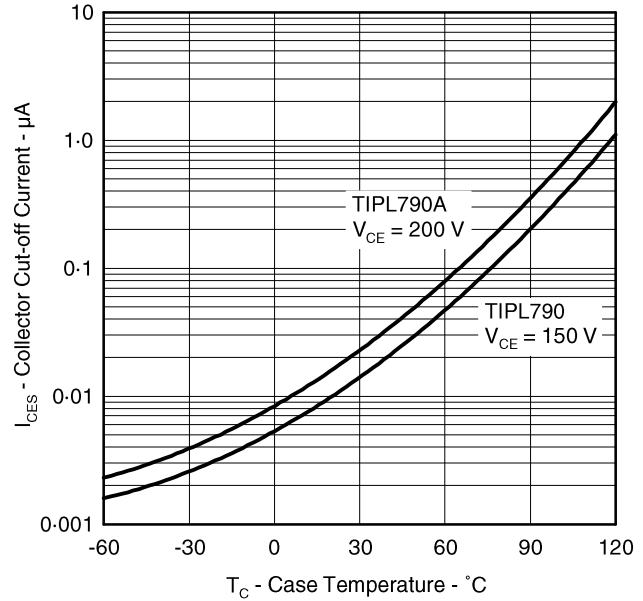

Figure 6.

MAXIMUM SAFE OPERATING REGIONS

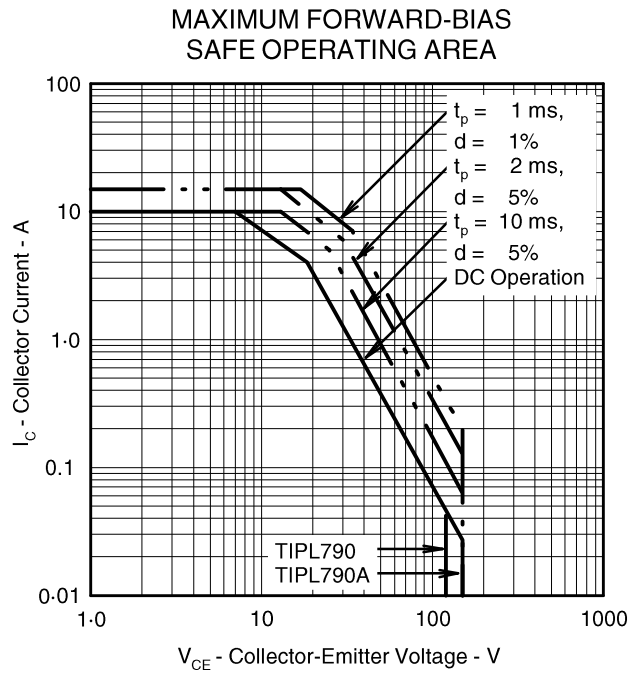

Figure 7.

**TIPL790, TIPL790A**  
**NPN SILICON POWER DARLINGTONS**

**MECHANICAL DATA**

**TO-220**

**3-pin plastic flange-mount package**

This single-in-line package consists of a circuit mounted on a lead frame and encapsulated within a plastic compound. The compound will withstand soldering temperature with no deformation, and circuit performance characteristics will remain stable when operated in high humidity conditions. Leads require no additional cleaning or processing when used in soldered assembly.

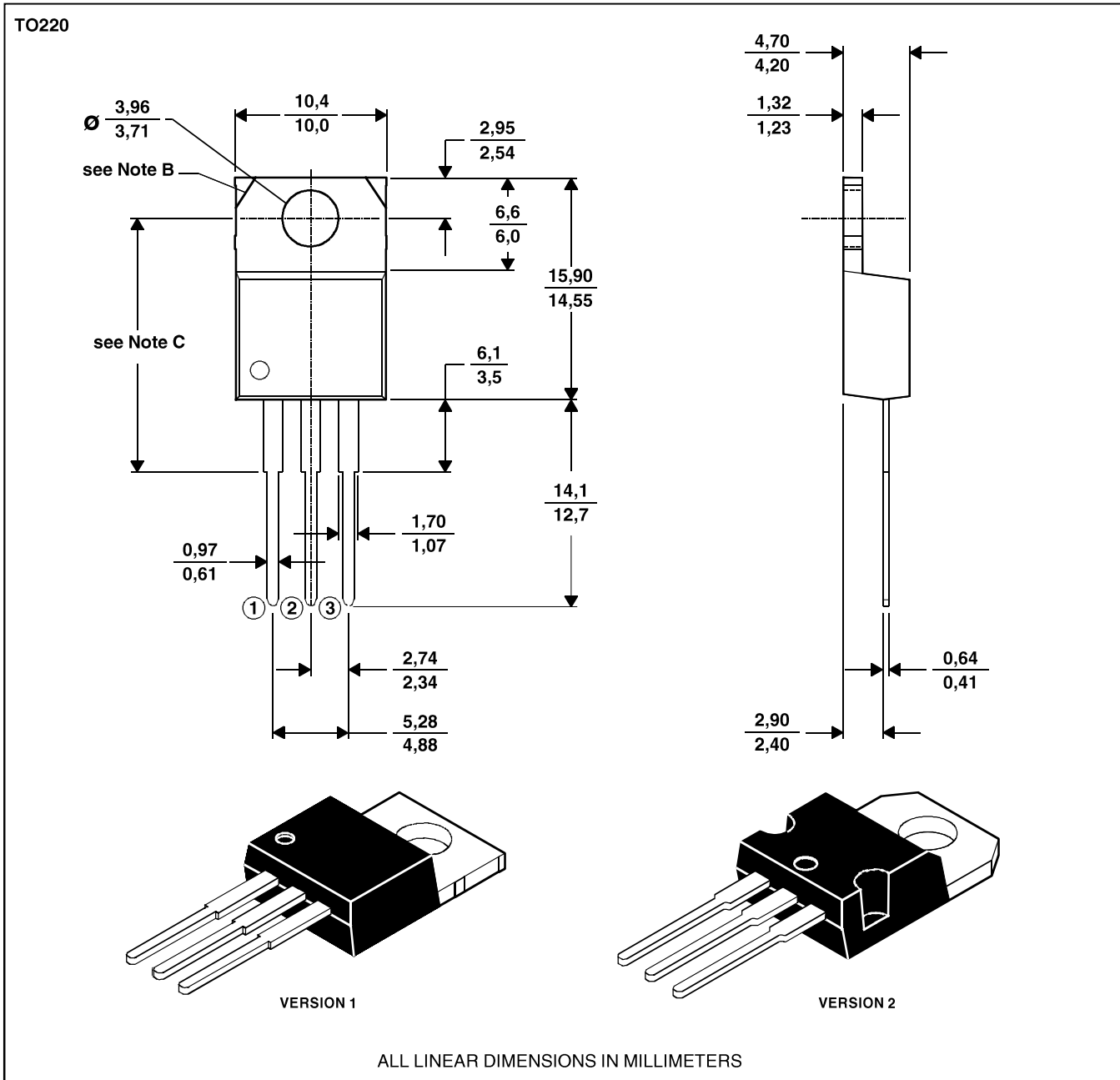

- NOTES: A. The centre pin is in electrical contact with the mounting tab.  
 B. Mounting tab corner profile according to package version.  
 C. Typical fixing hole centre stand off height according to package version.  
 Version 1, 18.0 mm. Version 2, 17.6 mm.