

APPLICATIONS

- Rectification
- Freewheel Diode
- DC Motor Control
- Power Supplies
- Welding
- Battery Chargers

KEY PARAMETERS

V_{RRM}	4000V
$I_{F(AV)}$	2850A
I_{FSM}	62500A

FEATURES

- Double Side Cooling
- High Surge Capability

VOLTAGE RATINGS

Type Number	Repetitive Peak Reverse Voltage V_{RRM} V	Conditions
TR2106SY40	4000	$V_{RSM} = V_{RRM} + 100V$
TR2106SY39	3900	
TR2106SY38	3800	
TR2106SY37	3700	
TR2106SY36	3600	
TR2106SY35	3500	

Lower voltage grades available.

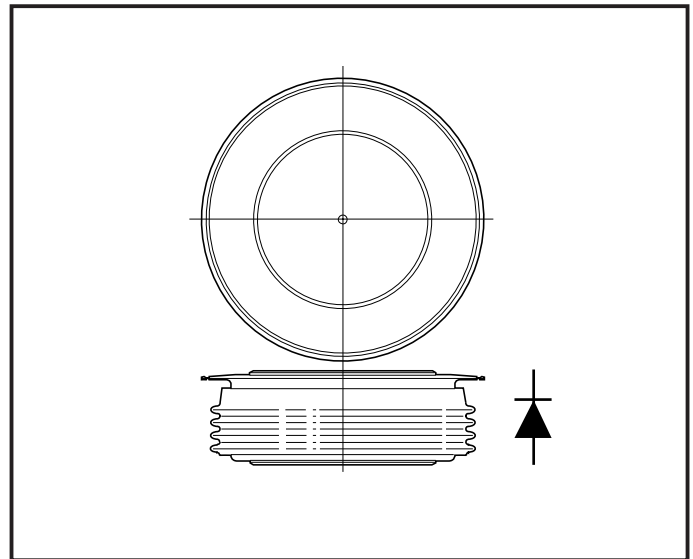

Outline type code: Y.
See package Details for further information.

CURRENT RATINGS

Symbol	Parameter	Conditions	Max.	Units
Double Side Cooled				
$I_{F(AV)}$	Mean forward current	Half wave resistive load, $T_{case} = 100^{\circ}C$	2850	A
$I_{F(RMS)}$	RMS value	$T_{case} = 100^{\circ}C$	4475	A
I_F	Continuous (direct) forward current	$T_{case} = 100^{\circ}C$	4190	A
Single Side Cooled (Anode side)				
$I_{F(AV)}$	Mean forward current	Half wave resistive load, $T_{case} = 100^{\circ}C$	1920	A
$I_{F(RMS)}$	RMS value	$T_{case} = 100^{\circ}C$	3014	A
I_F	Continuous (direct) forward current	$T_{case} = 100^{\circ}C$	2500	A

TR2106SY

SURGE RATINGS

Symbol	Parameter	Conditions	Max.	Units
I_{FSM}	Surge (non-repetitive) forward current	10ms half sine; $T_{case} = 150^{\circ}C$	50.0	kA
I^2t	I^2t for fusing	$V_R = 50\% V_{RRM}$ - 1/4 sine	12.5×10^6	A ² s
I_{FSM}	Surge (non-repetitive) forward current	10ms half sine; $T_{case} = 150^{\circ}C$	62.5	kA
I^2t	I^2t for fusing	$V_R = 0$	1.96×10^6	A ² s

THERMAL AND MECHANICAL DATA

Symbol	Parameter	Conditions	Min.	Max.	Units	
$R_{th(j-c)}$	Thermal resistance - junction to case	Double side cooled	dc	-	0.0095	$^{\circ}C/W$
		Single side cooled	Anode dc	-	0.019	$^{\circ}C/W$
			Cathode dc	-	0.019	$^{\circ}C/W$
$R_{th(c-h)}$	Thermal resistance - case to heatsink	Clamping force 43.0kN with mounting compound	Double side	-	0.002	$^{\circ}C/W$
			Single side	-	0.004	$^{\circ}C/W$
T_{vj}	Virtual junction temperature	Forward (conducting)	-	160	$^{\circ}C$	
		Reverse (blocking)	-	150	$^{\circ}C$	
T_{stg}	Storage temperature range		-55	150	$^{\circ}C$	
-	Clamping force		38.0	47.0	kN	

CHARACTERISTICS

Symbol	Parameter	Conditions	Min.	Max.	Units
V_{FM}	Forward voltage	At 3000A peak, $T_{case} = 25^{\circ}C$	-	1.15	V
I_{RRM}	Peak reverse current	At V_{RRM} , $T_{case} = 150^{\circ}C$	-	250	mA
Q_S	Total stored charge	$I_F = 2000A$, $dI_{RR}/dt = 3A/\mu s$	-	5000	μC
I_{RR}	Peak recovery current	$T_{case} = 150^{\circ}C$, $V_R = 100V$	-	150	A
V_{TO}	Threshold voltage	At $T_{vj} = 150^{\circ}C$	-	0.75	V
r_T	Slope resistance	At $T_{vj} = 150^{\circ}C$	-	0.118	m Ω

CURVES

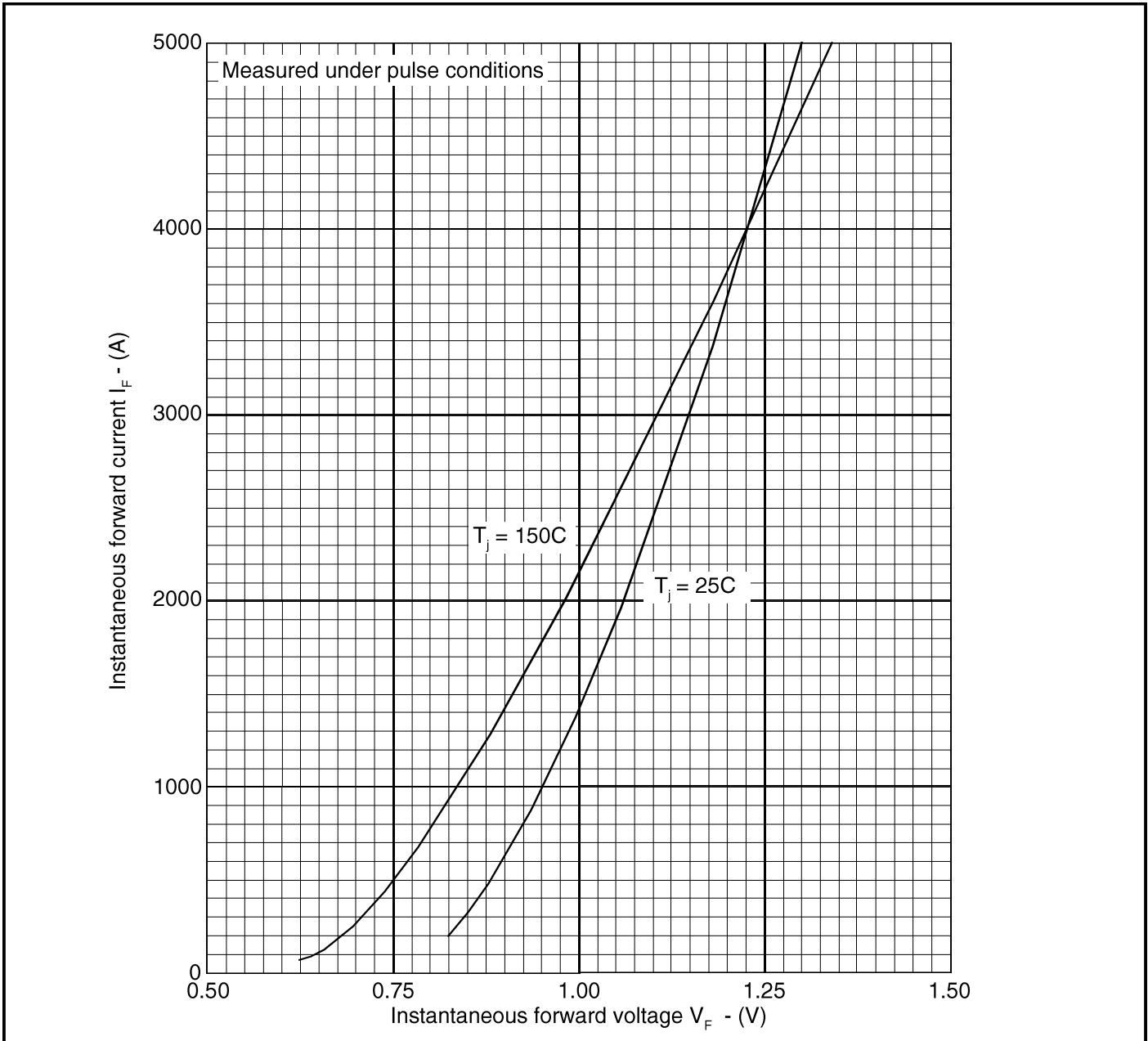

Fig. 1 Maximum (limit) forward characteristics

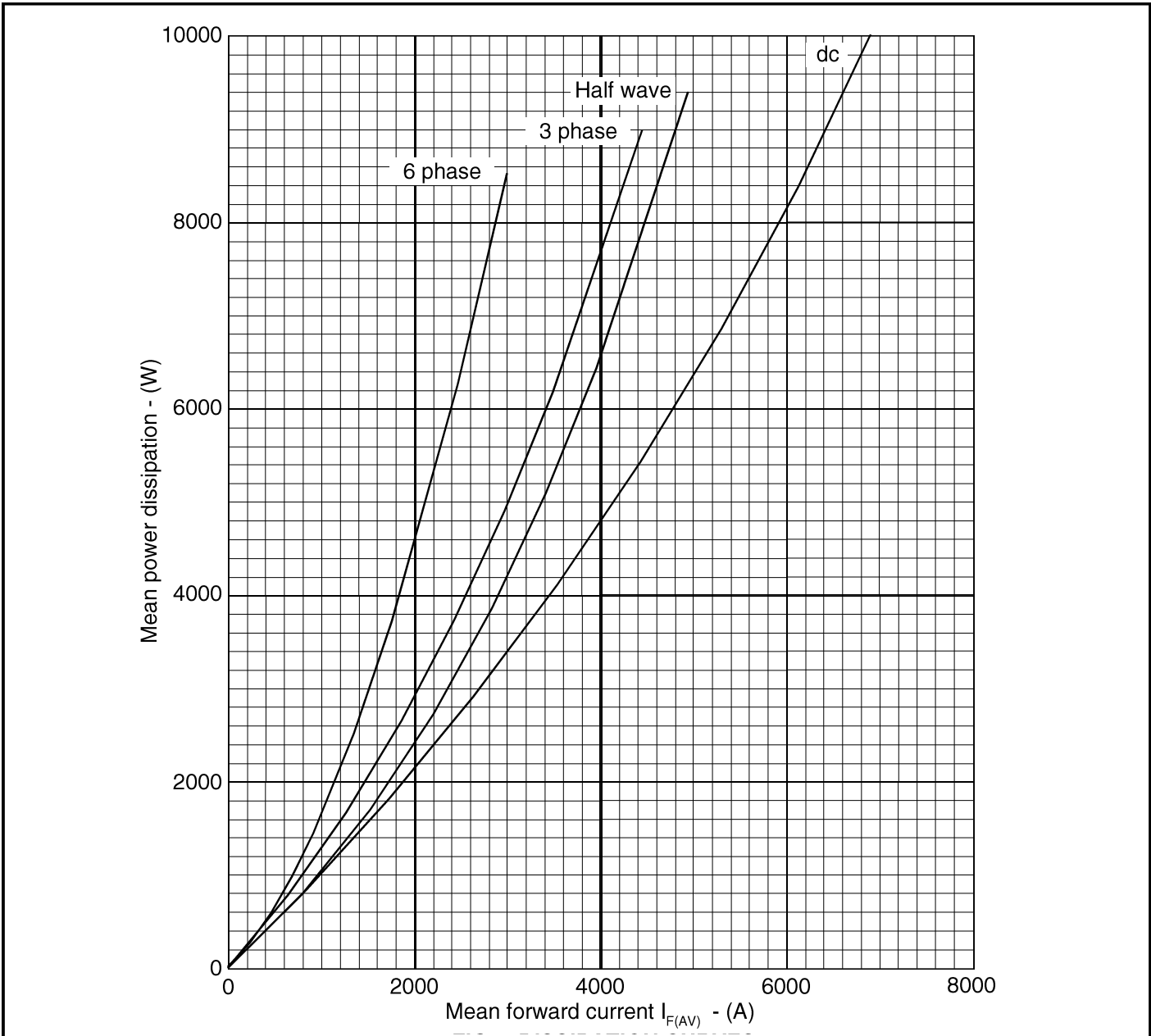

Fig. 2 Dissipation curves

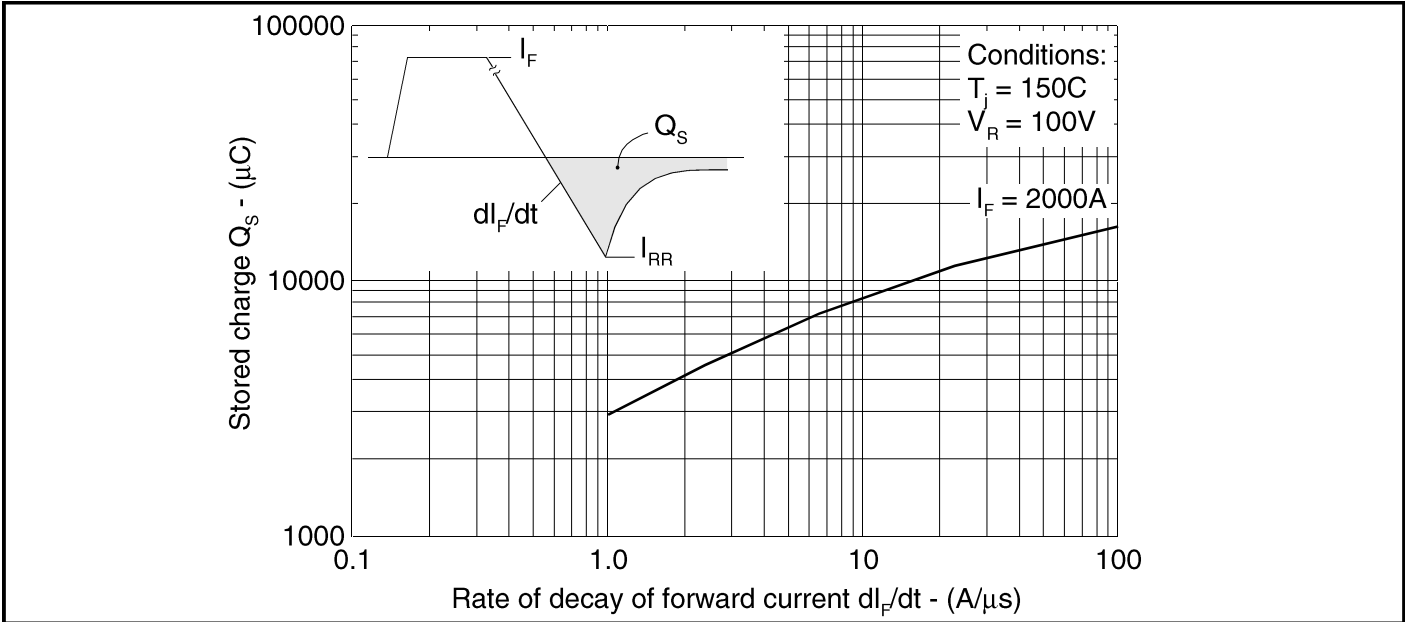

Fig. 3 Maximum stored charge

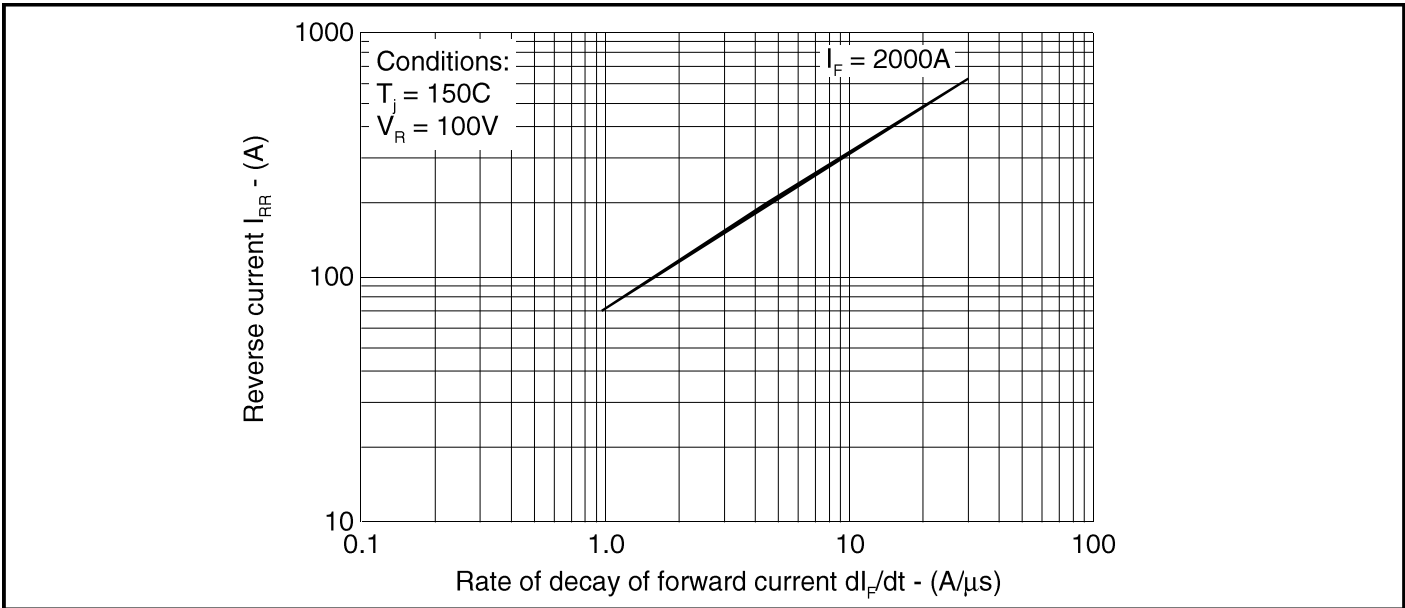

Fig. 4 Maximum reverse recovery current

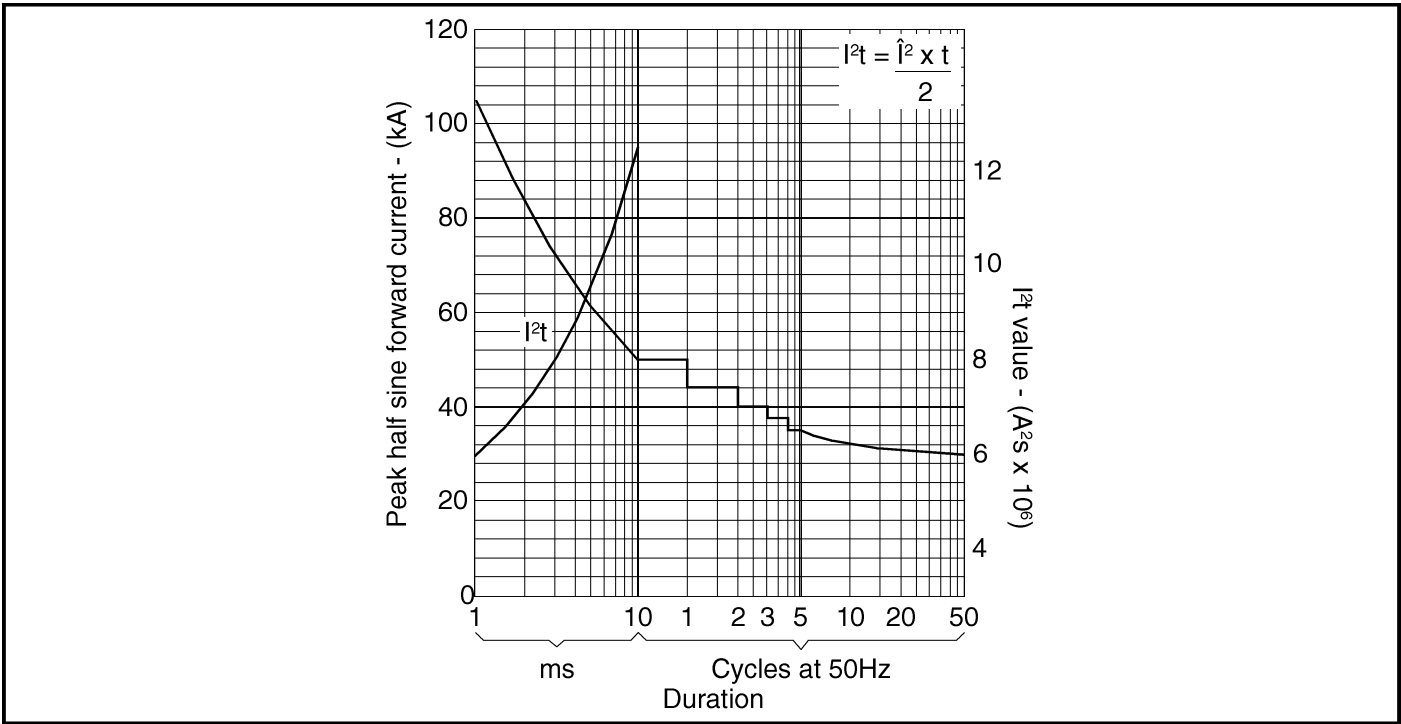

Fig. 5 Surge (non-repetitive) forward current vs time (with 50% V_{RRM} , $T_{case} = 150C$)

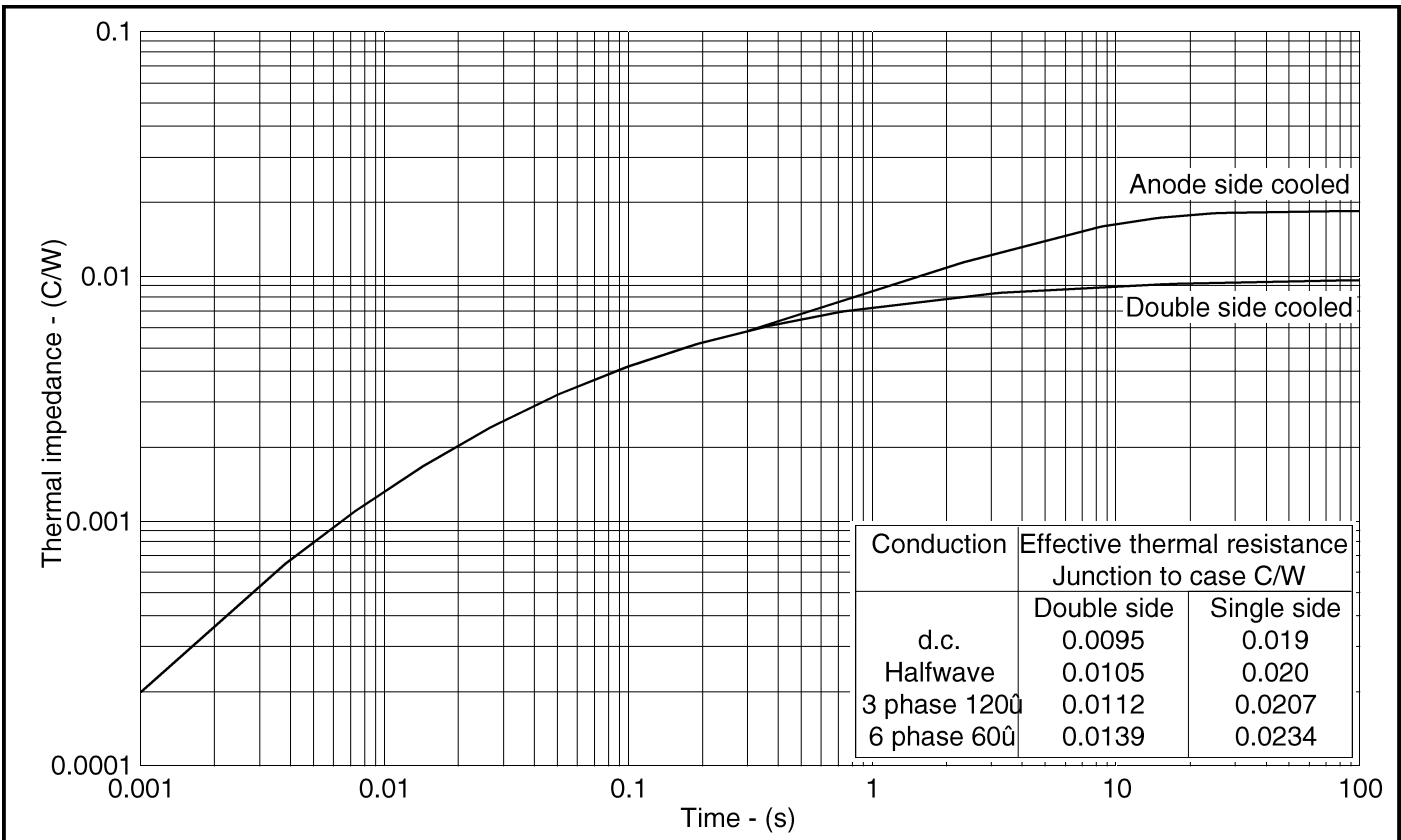

Fig. 6 Transient thermal impedance - junction to case - (C/W)

PACKAGE DETAILS

For further package information, please contact your local Customer Service Centre. All dimensions in mm, unless stated otherwise. DO NOT SCALE.

