

Resistor LED for 12 V Supply Voltage

Color	Type	Technology	Angle of Half Intensity $\pm\varphi$
Yellow	TLRE4200	AlInGaP on GaAs	22°

Description

These devices are developed for the automotive industry with special requirements as for EMC (electro magnetic compatibility) in motor vehicles with 12 V supply voltage.

They are resistant against transient conduction (high voltage spikes) and interferences by conduction and coupling.

The TLRE4200 series contains an integrated resistor for current limiting in series with the LED chip. This allows the lamp to be driven from a 12 V source without an external current limiter.

These tinted non-diffused lamps provide a high luminous intensity.

These LEDs are intended for space critical applications such as automobile instrument panels, switches and others which are driven from a 12 V source.

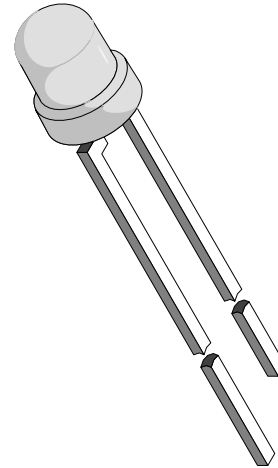

94 8488

Features

- With current limiting resistor for 12 V
- Resistant against transient high voltage spikes
- Cost effective: save space and resistor cost
- Standard \varnothing 3 mm (T-1) package
- High luminous intensity
- Luminous intensity categorized
- Yellow color categorized

Applications

Status light in cars
 OFF / ON indicator in cars
 Background illumination for switches
 Off / On indicator in switches

Absolute Maximum Ratings

$T_{amb} = 25^{\circ}\text{C}$, unless otherwise specified

TLRE4200

Parameter	Test Conditions	Symbol	Value	Unit
Reverse voltage		V_R	6	V
Forward voltage	$T_{amb} \leq 65^{\circ}\text{C}$	V_F	16	V
Power dissipation	$T_{amb} \leq 65^{\circ}\text{C}$	P_V	240	mW
Junction temperature		T_j	100	$^{\circ}\text{C}$
Storage temperature range		T_{stg}	-55 to +100	$^{\circ}\text{C}$
Soldering temperature	$t \leq 5\text{ s}$, 2 mm from body	T_{sd}	260	$^{\circ}\text{C}$
Thermal resistance junction/ambient		R_{thJA}	150	K/W

Optical and Electrical Characteristics

$T_{amb} = 25^{\circ}\text{C}$, unless otherwise specified

Yellow (TLRE4200)

Parameter	Test Conditions	Type	Symbol	Min	Typ	Max	Unit
Luminous intensity	$V_F = 12\text{ V}$		I_V	25			mcd
Dominant wavelength	$V_F = 12\text{ V}$		λ_d	581	588	594	nm
Peak wavelength	$V_F = 12\text{ V}$		λ_p		590		nm
Angle of half intensity	$V_F = 12\text{ V}$		ϕ		± 22		deg
Forward current	$V_S = 12\text{ V}$		I_F		10	12	mA
Breakdown voltage	$I_R = 10\ \mu\text{A}$		V_{BR}	6	50		V
Junction capacitance	$V_R = 0$, $f = 1\text{ MHz}$		C_j		50		pF

Typical Characteristics ($T_{amb} = 25^{\circ}\text{C}$, unless otherwise specified)

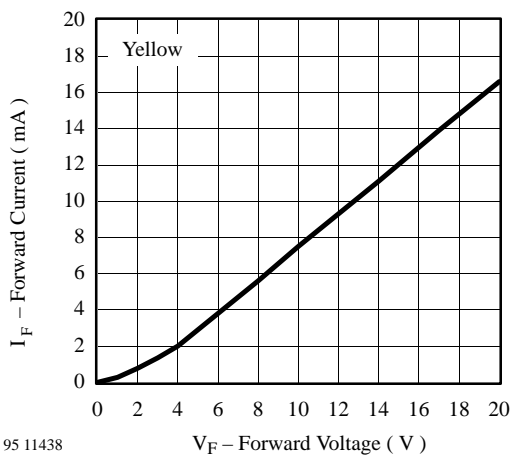

Figure 1 Forward Current vs. Forward Voltage

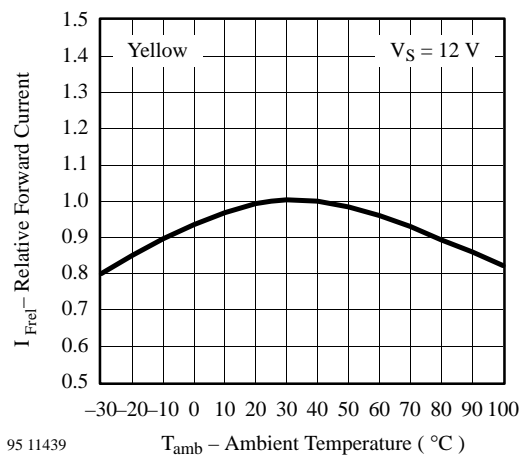
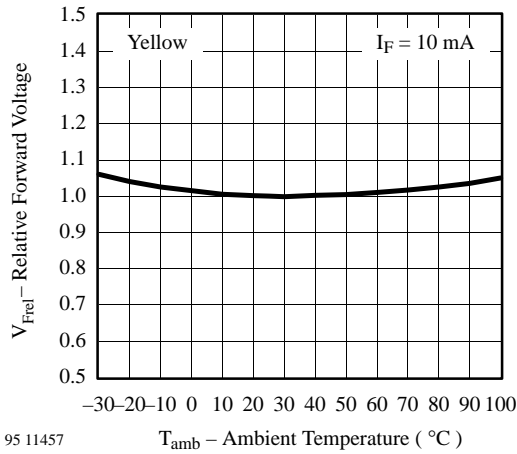
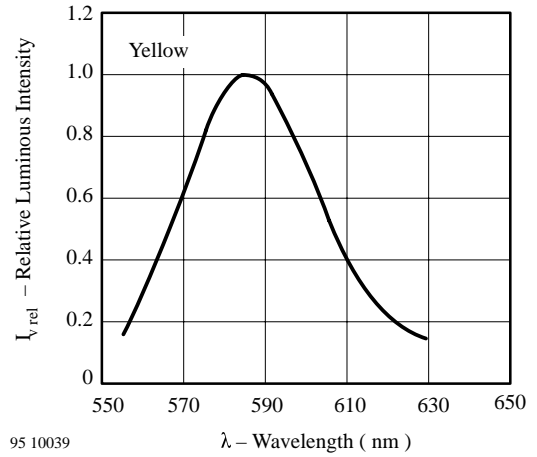

Figure 2 Relative Forward Current vs. Ambient Temperature



95 11457

Figure 3 Relative Forward Voltage vs. Ambient Temperature



95 10039

Figure 6 Relative Luminous Intensity vs. Wavelength

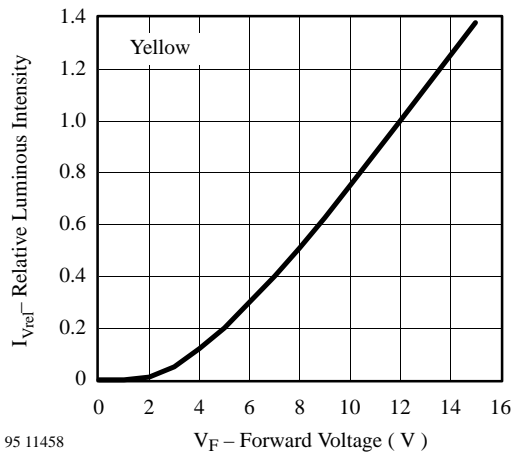

95 11458

Figure 4 Relative Luminous Intensity vs. Forward Voltage

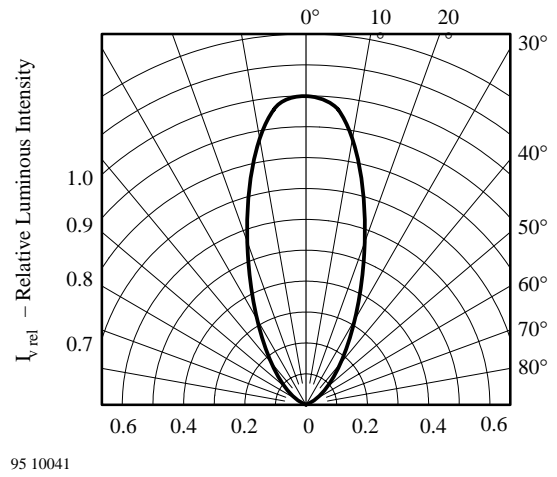

95 10041

Figure 7 Rel. Luminous Intensity vs. Angular Displacement

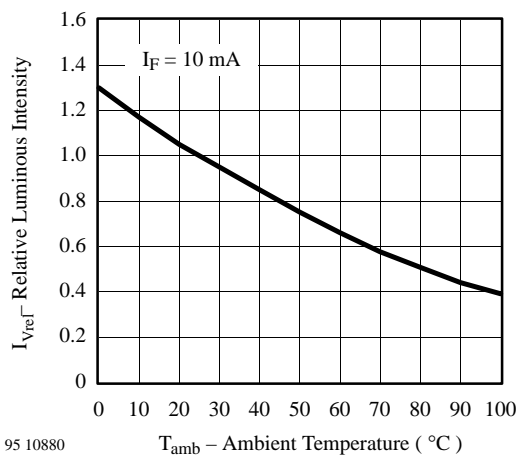

95 10880

Figure 5 Rel. Luminous Intensity vs. Ambient Temperature

Dimensions in mm

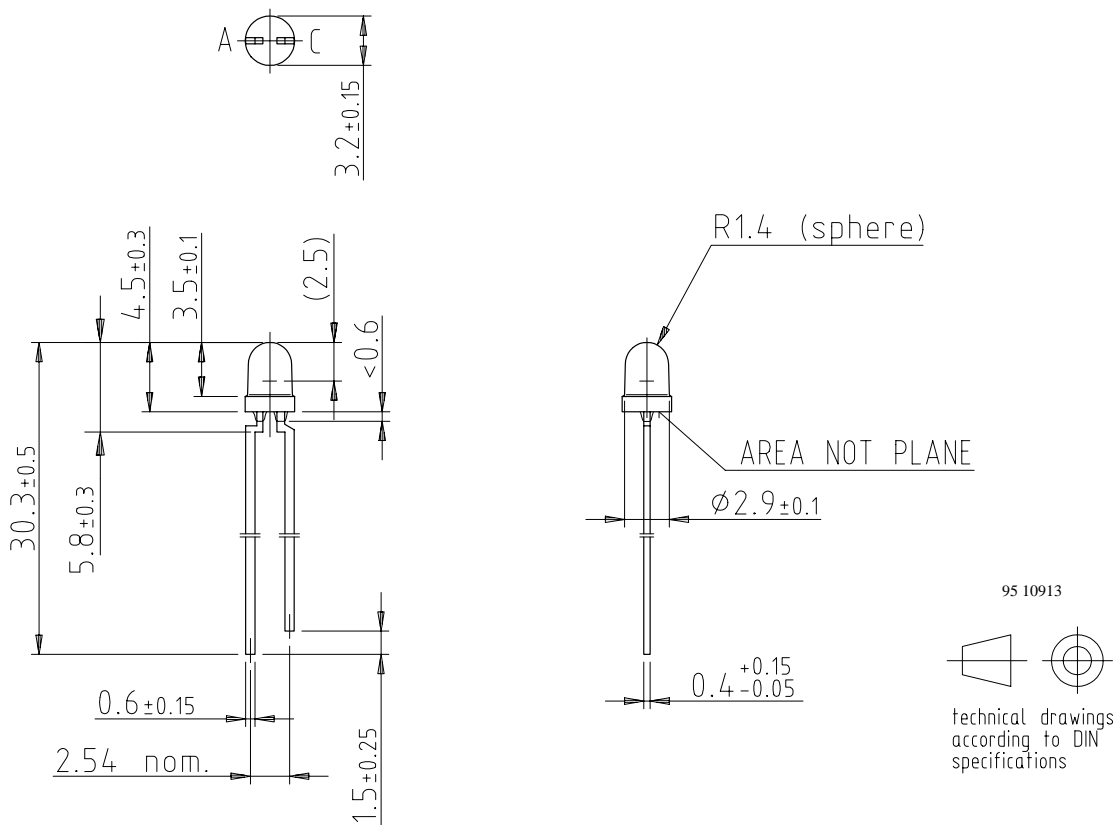



Ozone Depleting Substances Policy Statement

It is the policy of **Vishay Semiconductor GmbH** to

1. Meet all present and future national and international statutory requirements.
2. Regularly and continuously improve the performance of our products, processes, distribution and operating systems with respect to their impact on the health and safety of our employees and the public, as well as their impact on the environment.

It is particular concern to control or eliminate releases of those substances into the atmosphere which are known as ozone depleting substances (ODSs).

The Montreal Protocol (1987) and its London Amendments (1990) intend to severely restrict the use of ODSs and forbid their use within the next ten years. Various national and international initiatives are pressing for an earlier ban on these substances.

Vishay Semiconductor GmbH has been able to use its policy of continuous improvements to eliminate the use of ODSs listed in the following documents.

1. Annex A, B and list of transitional substances of the Montreal Protocol and the London Amendments respectively
2. Class I and II ozone depleting substances in the Clean Air Act Amendments of 1990 by the Environmental Protection Agency (EPA) in the USA
3. Council Decision 88/540/EEC and 91/690/EEC Annex A, B and C (transitional substances) respectively.

Vishay Semiconductor GmbH can certify that our semiconductors are not manufactured with ozone depleting substances and do not contain such substances.

We reserve the right to make changes to improve technical design and may do so without further notice.

Parameters can vary in different applications. All operating parameters must be validated for each customer application by the customer. Should the buyer use Vishay-Telefunken products for any unintended or unauthorized application, the buyer shall indemnify Vishay-Telefunken against all claims, costs, damages, and expenses, arising out of, directly or indirectly, any claim of personal damage, injury or death associated with such unintended or unauthorized use.

Vishay Semiconductor GmbH, P.O.B. 3535, D-74025 Heilbronn, Germany
Telephone: 49 (0) 7131 67 2831, Fax number: 49 (0) 7131 67 2423