

Symbol LED, 2.5 x 5 mm Flat Tinted Top-Diffused Package

Color	Type	Technology	Angle of Half Intensity $\pm\varphi$
Red	TLSH510.	GaAsP on GaP	50°
Yellow	TLSY510.	GaAsP on GaP	50°
Green	TLSG510.	GaP on GaP	50°

Description

This series was developed for use as compact surface display.

It is housed in a 2.5x5 mm rectangular molded package. This device has a flat tinted, top diffused package for uniform brightness when used in panels. The symbol LEDs are available in three bright colors: high efficiency red, yellow and green.

Features

- Choice of three bright colors
- Uniform illumination
- Luminous intensity selected into groups
- Suitable for DC and pulse operation
- Flat light emitting surface
- Direct symbol indication is possible
- Yellow and green color categorized
- Wide viewing angle

Applications

Status lights
Background illumination
Maintenance lights
Indicator of audio and visual equipment
Off / On indicator
Readout lights
Legend lights
Illumination of moving boards

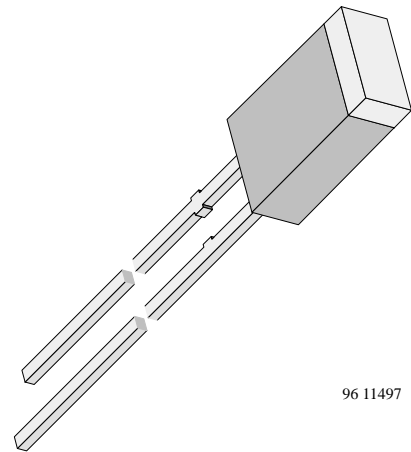

96 11497

Absolute Maximum Ratings

$T_{amb} = 25^{\circ}\text{C}$, unless otherwise specified

TL5H510., T5Y510., T5G510.,

Parameter	Test Conditions	Symbol	Value	Unit
Reverse voltage		V_R	6	V
DC forward current		I_F	30	mA
Surge forward current	$t_p \leq 10 \mu\text{s}$	I_{FSM}	1	A
Power dissipation	$T_{amb} \leq 65^{\circ}\text{C}$	P_V	100	mW
Junction temperature		T_j	100	$^{\circ}\text{C}$
Storage temperature range		T_{stg}	-55 to +100	$^{\circ}\text{C}$
Soldering temperature	$t \leq 5 \text{ s}$, 2 mm from body	T_{sd}	260	$^{\circ}\text{C}$
Thermal resistance junction/ambient		R_{thJA}	350	K/W

Optical and Electrical Characteristics

$T_{amb} = 25^{\circ}\text{C}$, unless otherwise specified

Red (TL5H510.)

Parameter	Test Conditions	Type	Symbol	Min	Typ	Max	Unit
Luminous intensity	$I_F = 10 \text{ mA}$, $I_{Vmin}/I_{Vmax} \geq 0.5$	TL5H5100	I_V	0.63	1.5		mcd
		TL5H5101	I_V	1	2		mcd
Dominant wavelength	$I_F = 10 \text{ mA}$		λ_d		640		nm
Peak wavelength	$I_F = 10 \text{ mA}$		λ_p		650		nm
Angle of half intensity	$I_F = 10 \text{ mA}$		ϕ		± 50		deg
Forward voltage	$I_F = 20 \text{ mA}$		V_F		2	3	V
Reverse voltage	$I_R = 10 \mu\text{A}$		V_R	6	15		V
Junction capacitance	$V_R = 0$, $f = 1 \text{ MHz}$		C_j		50		pF

Yellow (T5Y510.)

Parameter	Test Conditions	Type	Symbol	Min	Typ	Max	Unit
Luminous intensity	$I_F = 10 \text{ mA}$, $I_{Vmin}/I_{Vmax} \geq 0.5$	T5Y5100	I_V	0.4	1		mcd
		T5Y5101	I_V	1	3		mcd
Dominant wavelength	$I_F = 10 \text{ mA}$		λ_d	581		594	nm
Peak wavelength	$I_F = 10 \text{ mA}$		λ_p		585		nm
Angle of half intensity	$I_F = 10 \text{ mA}$		ϕ		± 50		deg
Forward voltage	$I_F = 20 \text{ mA}$		V_F		2.4	3	V
Reverse voltage	$I_R = 10 \mu\text{A}$		V_R	6	15		V
Junction capacitance	$V_R = 0$, $f = 1 \text{ MHz}$		C_j		50		pF

Green (TLSG510.)

Parameter	Test Conditions	Type	Symbol	Min	Typ	Max	Unit
Luminous intensity	$I_F = 10 \text{ mA}$, $I_{V\text{min}}/I_{V\text{max}} \geq 0.5$	TLSG5100	I_V	0.4	1		mcd
		TLSG5101	I_V	1	2		mcd
Dominant wavelength	$I_F = 10 \text{ mA}$		λ_d	562		575	nm
Peak wavelength	$I_F = 10 \text{ mA}$		λ_p		565		nm
Angle of half intensity	$I_F = 10 \text{ mA}$		ϕ		± 50		deg
Forward voltage	$I_F = 20 \text{ mA}$		V_F		2.4	3	V
Reverse voltage	$I_R = 10 \mu\text{A}$		V_R	6	15		V
Junction capacitance	$V_R = 0$, $f = 1 \text{ MHz}$		C_j		50		pF

Typical Characteristics ($T_{\text{amb}} = 25^\circ\text{C}$, unless otherwise specified)

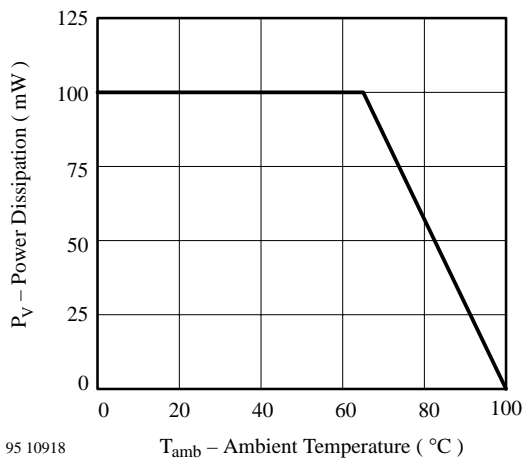

Figure 1 Power Dissipation vs. Ambient Temperature

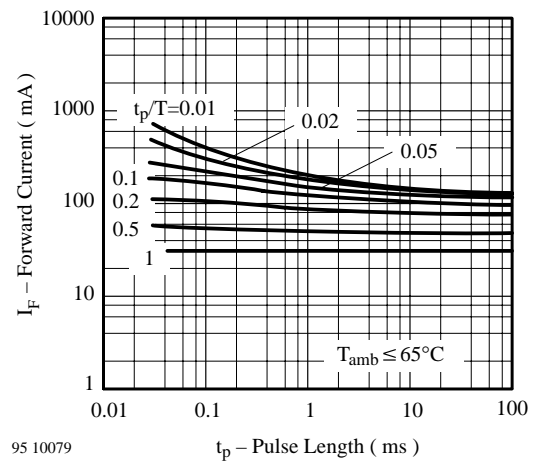

Figure 3 Forward Current vs. Pulse Length

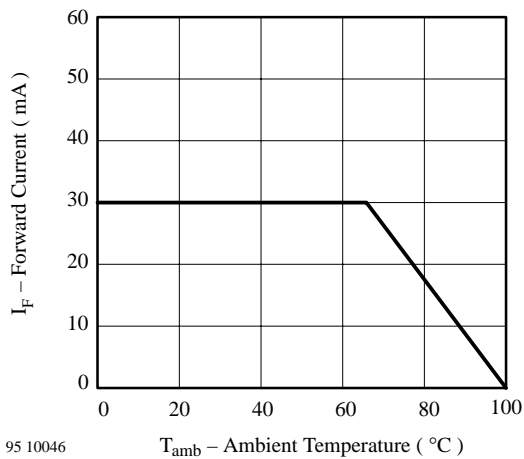

Figure 2 Forward Current vs. Ambient Temperature

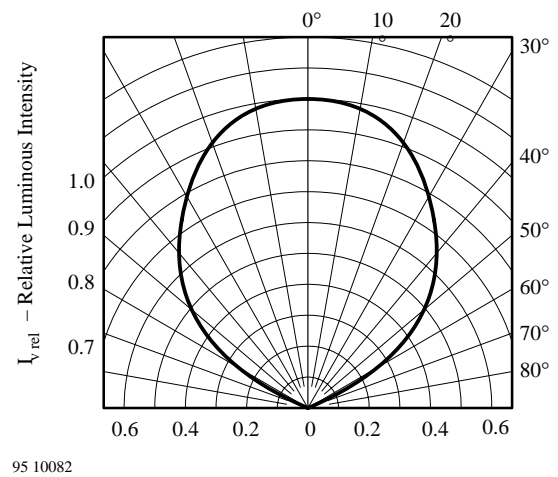
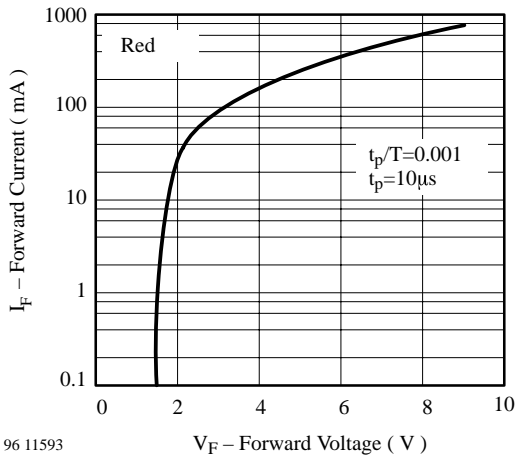
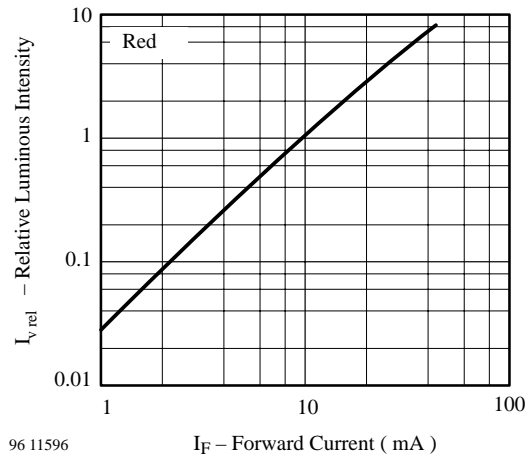

Figure 4 Rel. Luminous Intensity vs. Angular Displacement



96 11593

Figure 5 Forward Current vs. Forward Voltage



96 11596

Figure 8 Rel. Luminous Intensity vs. Forward Current

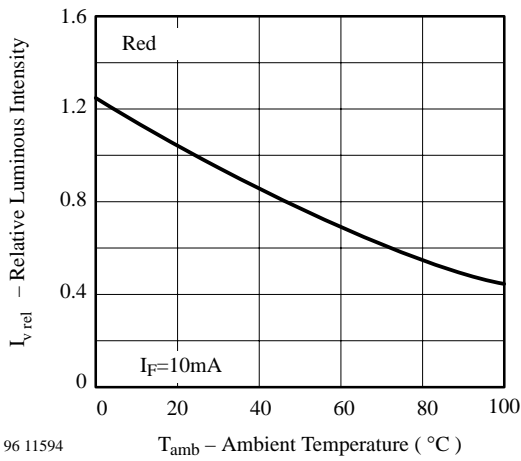

96 11594

Figure 6 Rel. Luminous Intensity vs. Ambient Temperature

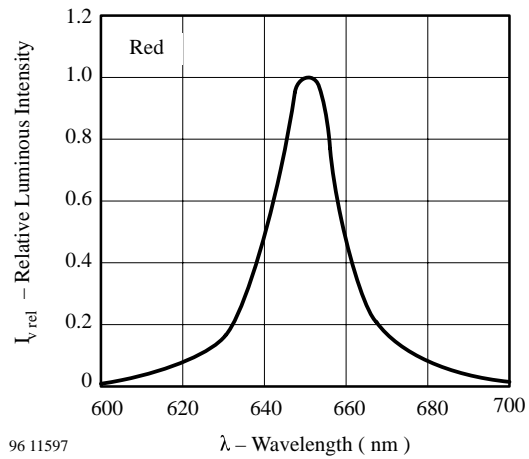

96 11597

Figure 9 Rel. Luminous Intensity vs. Wavelength

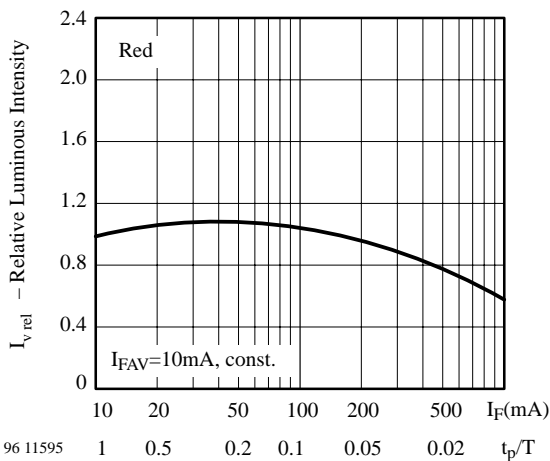

96 11595

Figure 7 Rel. Lumin. Intensity vs. Forw. Current / Duty Cycle

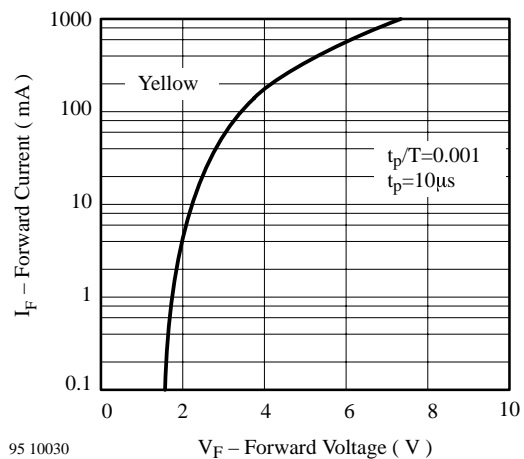

95 10030

Figure 10 Forward Current vs. Forward Voltage

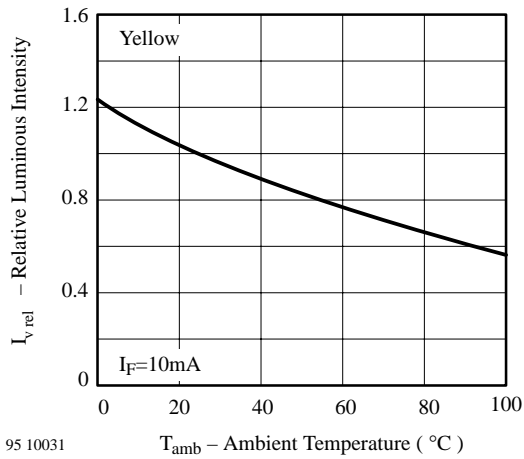

95 10031

Figure 11 Rel. Luminous Intensity vs. Ambient Temperature

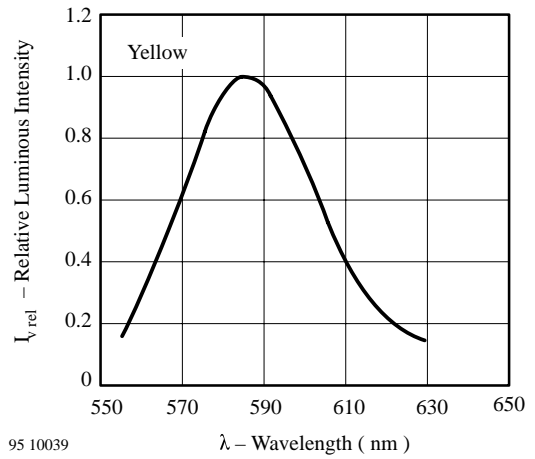

95 10039

Figure 14 Relative Luminous Intensity vs. Wavelength

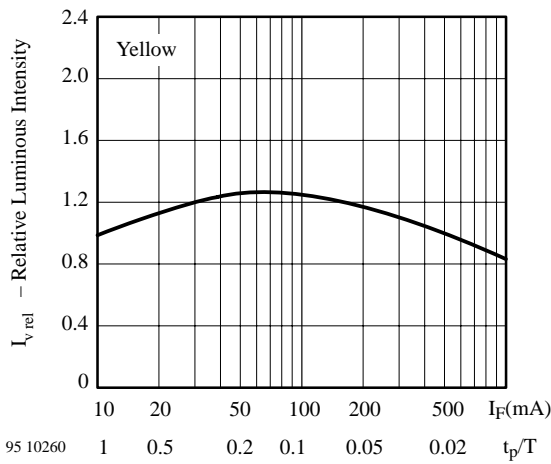

95 10260

Figure 12 Rel. Lumin. Intensity vs. Forw. Current/Duty Cycle

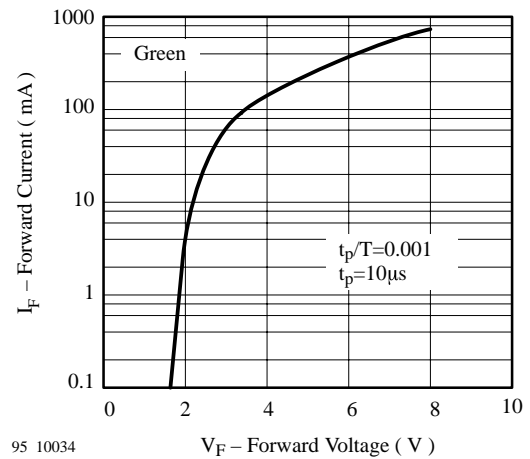

95 10034

Figure 15 Rel. Luminous Intensity vs. Ambient Temperature

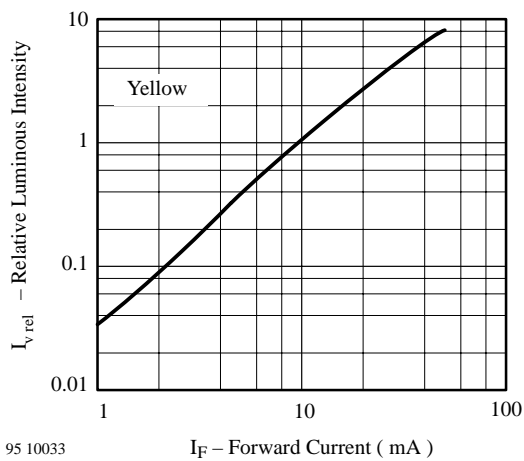

95 10033

Figure 13 Relative Luminous Intensity vs. Forward Current

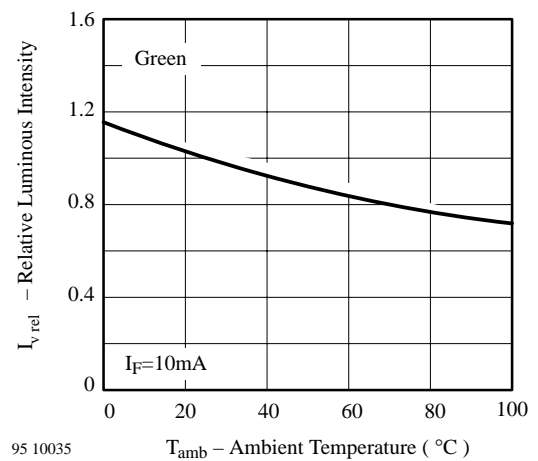

95 10035

Figure 16 Rel. Luminous Intensity vs. Ambient Temperature

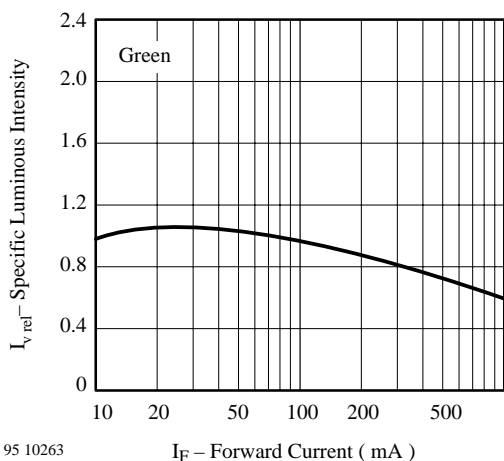

Figure 17 Specific Luminous Intensity vs. Forward Current

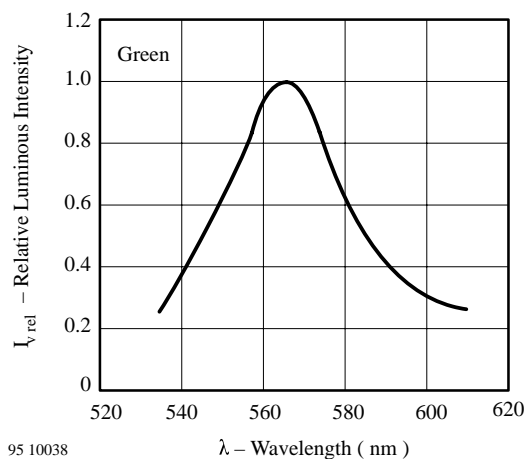

Figure 19 Relative Luminous Intensity vs. Wavelength

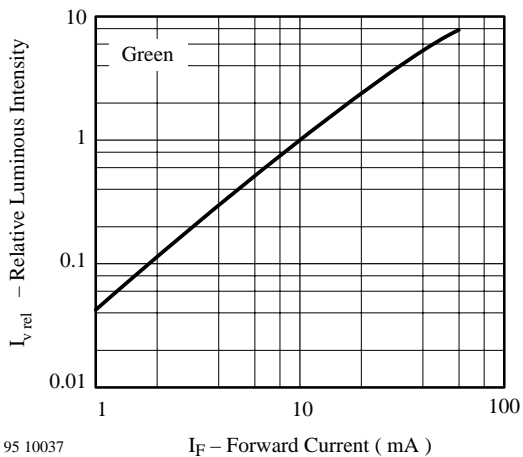
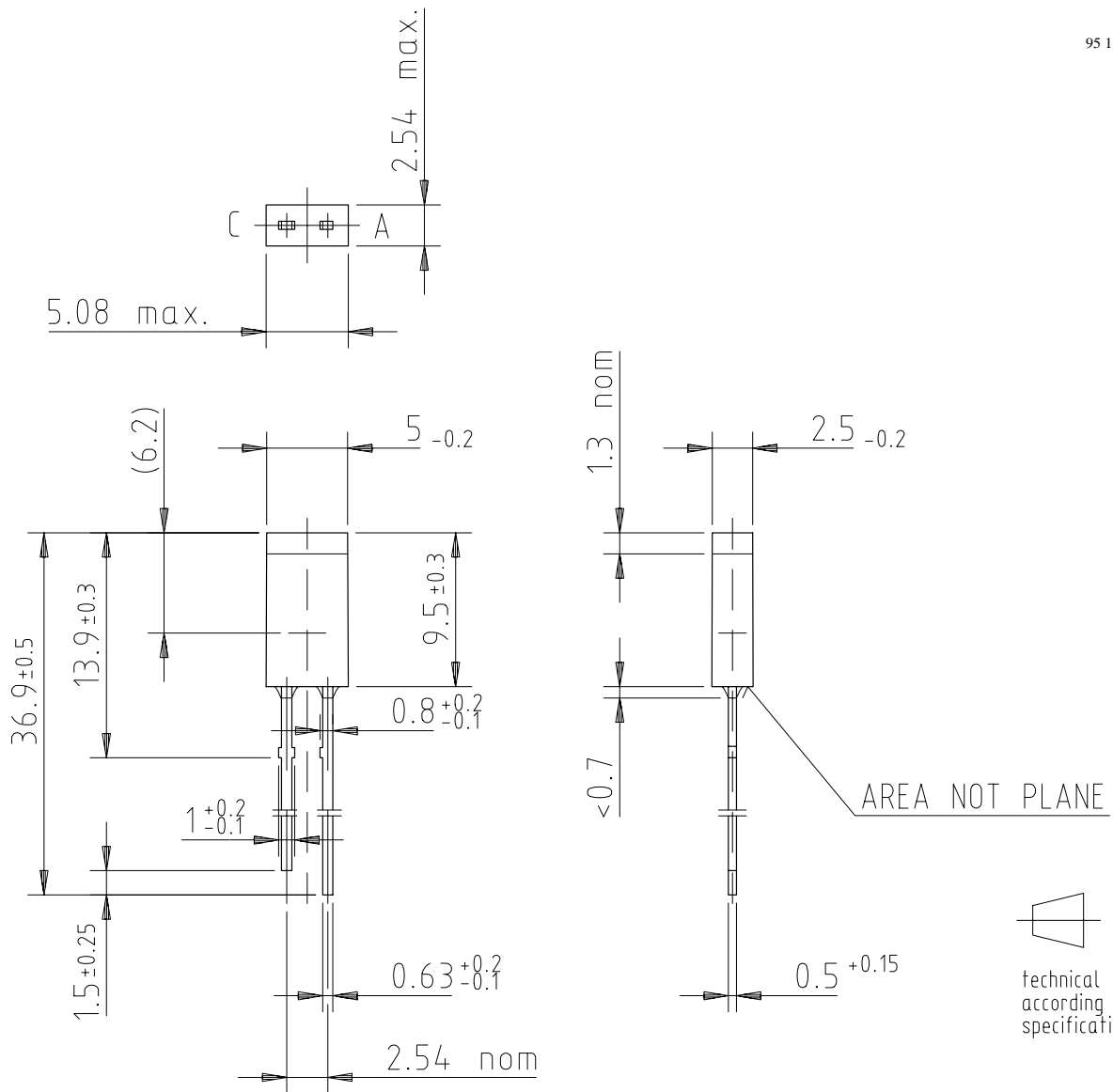

Figure 18 Relative Luminous Intensity vs. Forward Current

Dimensions in mm

95 11326



Ozone Depleting Substances Policy Statement

It is the policy of **Vishay Semiconductor GmbH** to

1. Meet all present and future national and international statutory requirements.
2. Regularly and continuously improve the performance of our products, processes, distribution and operating systems with respect to their impact on the health and safety of our employees and the public, as well as their impact on the environment.

It is particular concern to control or eliminate releases of those substances into the atmosphere which are known as ozone depleting substances (ODSs).

The Montreal Protocol (1987) and its London Amendments (1990) intend to severely restrict the use of ODSs and forbid their use within the next ten years. Various national and international initiatives are pressing for an earlier ban on these substances.

Vishay Semiconductor GmbH has been able to use its policy of continuous improvements to eliminate the use of ODSs listed in the following documents.

1. Annex A, B and list of transitional substances of the Montreal Protocol and the London Amendments respectively
2. Class I and II ozone depleting substances in the Clean Air Act Amendments of 1990 by the Environmental Protection Agency (EPA) in the USA
3. Council Decision 88/540/EEC and 91/690/EEC Annex A, B and C (transitional substances) respectively.

Vishay Semiconductor GmbH can certify that our semiconductors are not manufactured with ozone depleting substances and do not contain such substances.

We reserve the right to make changes to improve technical design and may do so without further notice.

Parameters can vary in different applications. All operating parameters must be validated for each customer application by the customer. Should the buyer use Vishay-Telefunken products for any unintended or unauthorized application, the buyer shall indemnify Vishay-Telefunken against all claims, costs, damages, and expenses, arising out of, directly or indirectly, any claim of personal damage, injury or death associated with such unintended or unauthorized use.

Vishay Semiconductor GmbH, P.O.B. 3535, D-74025 Heilbronn, Germany
Telephone: 49 (0) 7131 67 2831, Fax number: 49 (0) 7131 67 2423