

Silicon NPN Phototransistor

Description

TEMT1000 is a high speed and high sensitive silicon NPN epitaxial planar phototransistor in SMT package with dome lens. Due to its integrated Daylight filter the device is sensitive for IR radiation only. High on axis sensitivity is provided by a viewing angle of $\pm 15^\circ$.

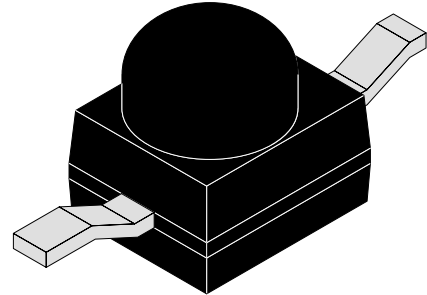

15 970

Features

- Fast response times
- High photo sensitivity
- Angle of half sensitivity $\varphi = \pm 15^\circ$
- Daylight filter matched for near IR radiation
- SMD with terminals Z-bend

Applications

Detector in electronic control and drive circuits
IR Detector for Daylight application

Absolute Maximum Ratings

$T_{amb} = 25^\circ\text{C}$

| Parameter | Test Conditions | Symbol | Value | Unit |
|-----------------------------|--|-----------|-----------|------------------|
| Collector Emitter Voltage | | V_{CEO} | 70 | V |
| Emitter Collector Voltage | | V_{ECO} | 5 | V |
| Collector Current | | I_C | 50 | mA |
| Peak Collector Current | $t_p/T = 0.5, t_p \leq 10 \text{ ms}$ | I_{CM} | 100 | mA |
| Total Power Dissipation | $T_{amb} \leq 55^\circ\text{C}$ | P_{tot} | 100 | mW |
| Junction Temperature | | T_j | 100 | $^\circ\text{C}$ |
| Storage Temperature Range | | T_{stg} | -40...+85 | $^\circ\text{C}$ |
| Operating Temperature Range | | T_{amb} | -40...+85 | $^\circ\text{C}$ |
| Soldering Temperature | $t \leq 3 \text{ s}, 2 \text{ mm from case}$ | T_{sd} | 260 | $^\circ\text{C}$ |

Basic Characteristics

$T_{amb} = 25^{\circ}\text{C}$

| Parameter | Test Conditions | Symbol | Min | Typ | Max | Unit |
|--------------------------------------|---|-----------------|-----|-----------|-----|---------------|
| Collector Emitter Breakdown Voltage | $I_C = 1\text{ mA}$ | $V_{(BR)CE\ O}$ | 70 | | | V |
| Collector Dark Current | $V_{CE} = 20\text{ V}, E = 0$ | I_{CEO} | | 1 | 200 | nA |
| Collector Emitter Capacitance | $V_{CE} = 5\text{ V}, f = 1\text{ MHz}, E=0$ | C_{CEO} | | 3 | | pF |
| Angle of Half Sensitivity | | ϕ | | ± 15 | | deg |
| Wavelength of Peak Sensitivity | | λ_p | | 850 | | nm |
| Range of Spectral Bandwidth | | $\lambda_{0.5}$ | | 750...980 | | nm |
| Collector Emitter Saturation Voltage | $E_e = 1\text{ mW/cm}^2,$ $\lambda = 950\text{ nm}, I_C = 0.1\text{ mA}$ | V_{CEsat} | | | 0.3 | V |
| Turn-On Time | $V_S = 5\text{ V}, I_C = 5\text{ mA},$ $R_L = 100\ \Omega$ | t_{on} | | 2.0 | | μs |
| Turn-Off Time | $V_S = 5\text{ V}, I_C = 5\text{ mA},$ $R_L = 100\ \Omega$ | t_{off} | | 2.3 | | μs |
| Cut-Off Frequency | $V_S = 5\text{ V}, I_C = 5\text{ mA},$ $R_L = 100\ \Omega$ | f_c | | 180 | | kHz |

Type Dedicated Characteristics

$T_{amb} = 25^{\circ}\text{C}$

| Parameter | Test Conditions | Type | Symbol | Min | Typ | Max | Unit |
|-------------------------|---|----------|----------|-----|-----|-----|------|
| Collector Light Current | $E_e = 1\text{ mW/cm}^2,$ $\lambda = 950\text{ nm}, V_{CE} = 5\text{ V}$ | TEMT1000 | I_{ca} | 2.0 | 7.0 | | mA |

Typical Characteristics ($T_{amb} = 25^{\circ}\text{C}$ unless otherwise specified)

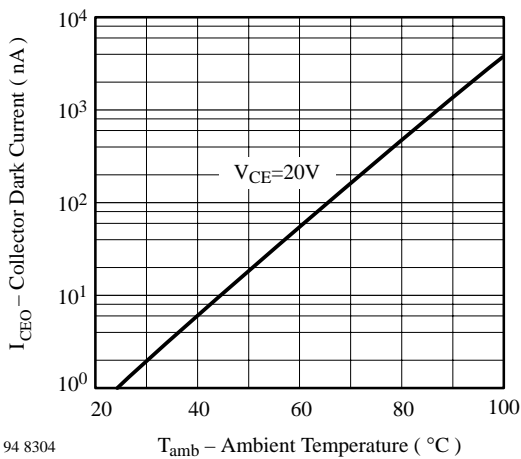

Figure 1. Collector Dark Current vs. Ambient Temperature

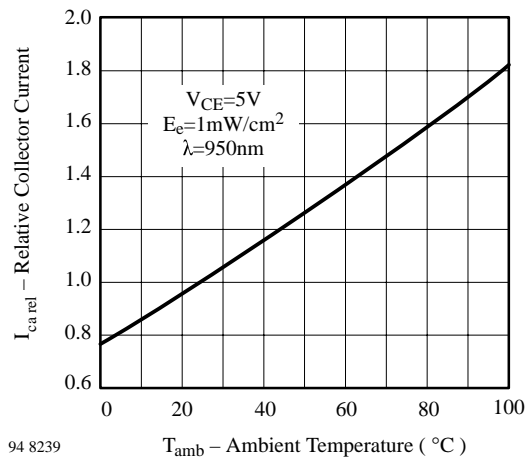

Figure 2. Relative Collector Current vs. Ambient Temperature

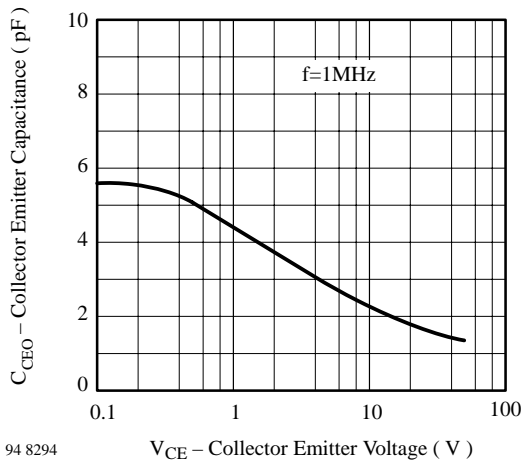

Figure 3. Collector Emitter Capacitance vs. Collector Emitter Voltage

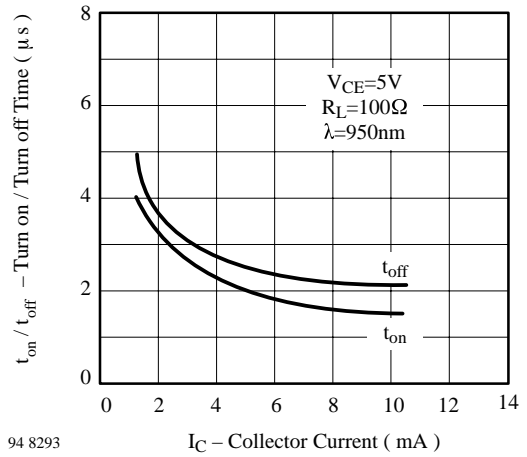

Figure 5. Turn On/Turn Off Time vs. Collector Current

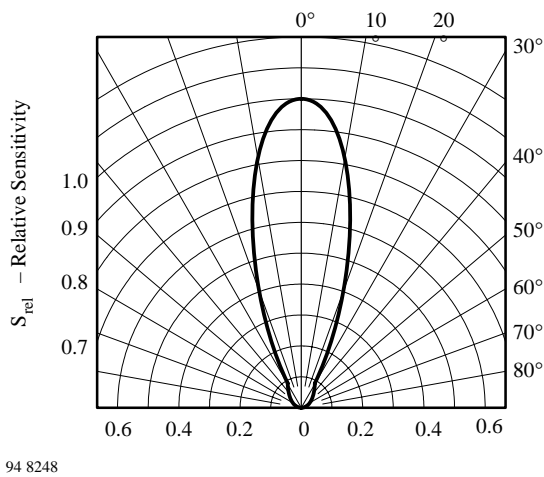
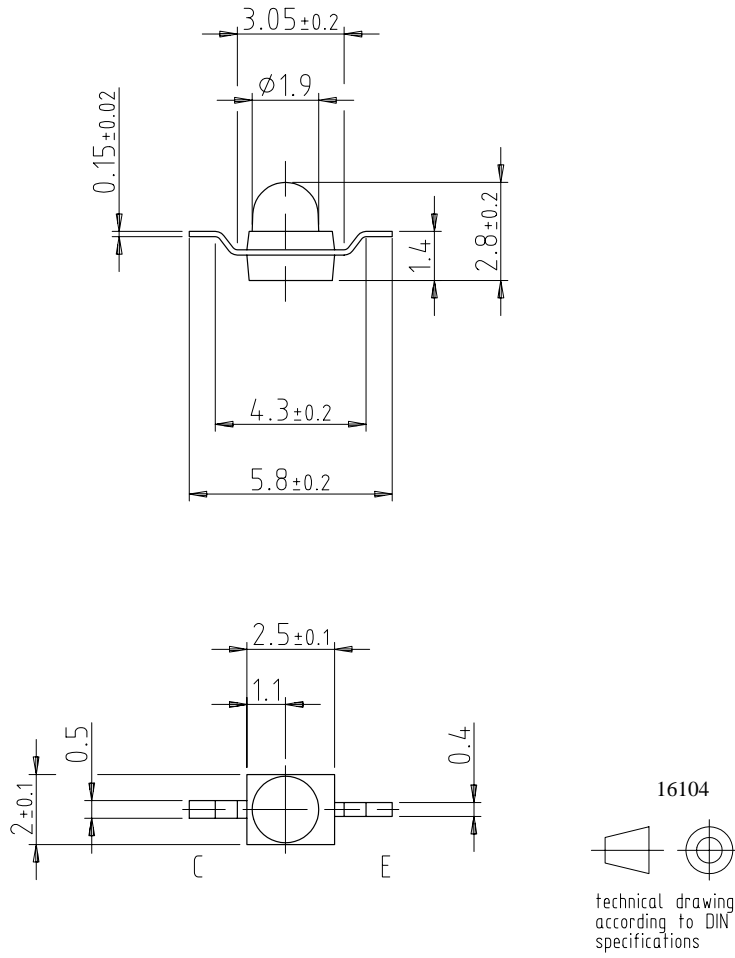

Figure 4. Relative Radiant Sensitivity vs. Angular Displacement

Dimensions in mm





Ozone Depleting Substances Policy Statement

It is the policy of **Vishay Semiconductor GmbH** to

1. Meet all present and future national and international statutory requirements.
2. Regularly and continuously improve the performance of our products, processes, distribution and operating systems with respect to their impact on the health and safety of our employees and the public, as well as their impact on the environment.

It is particular concern to control or eliminate releases of those substances into the atmosphere which are known as ozone depleting substances (ODSs).

The Montreal Protocol (1987) and its London Amendments (1990) intend to severely restrict the use of ODSs and forbid their use within the next ten years. Various national and international initiatives are pressing for an earlier ban on these substances.

Vishay Semiconductor GmbH has been able to use its policy of continuous improvements to eliminate the use of ODSs listed in the following documents.

1. Annex A, B and list of transitional substances of the Montreal Protocol and the London Amendments respectively
2. Class I and II ozone depleting substances in the Clean Air Act Amendments of 1990 by the Environmental Protection Agency (EPA) in the USA
3. Council Decision 88/540/EEC and 91/690/EEC Annex A, B and C (transitional substances) respectively.

Vishay Semiconductor GmbH can certify that our semiconductors are not manufactured with ozone depleting substances and do not contain such substances.

We reserve the right to make changes to improve technical design and may do so without further notice.

Parameters can vary in different applications. All operating parameters must be validated for each customer application by the customer. Should the buyer use Vishay-Telefunken products for any unintended or unauthorized application, the buyer shall indemnify Vishay-Telefunken against all claims, costs, damages, and expenses, arising out of, directly or indirectly, any claim of personal damage, injury or death associated with such unintended or unauthorized use.

Vishay Semiconductor GmbH, P.O.B. 3535, D-74025 Heilbronn, Germany
Telephone: 49 (0)7131 67 2831, Fax number: 49 (0)7131 67 2423