

# Schottky Barrier Rectifier

## Features

- High efficiency
- Low power losses
- Very low switching losses
- Low reverse current
- High surge capability

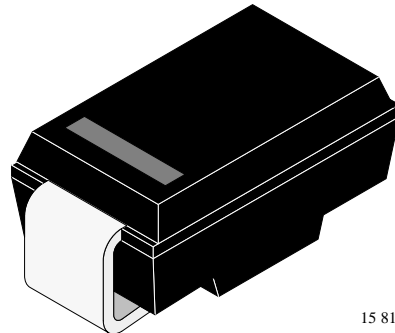

15 811

## Applications

Polarity protection  
Low voltage, high frequency rectifiers

## Absolute Maximum Ratings

$T_j = 25^\circ\text{C}$

Parameter	Test Conditions	Type	Symbol	Value	Unit
Reverse voltage =Repetitive peak reverse voltage			$V_R$ $=V_{RRM}$	90	V
Peak forward surge current	$t_p=10\text{ms}$ , half sinewave		$I_{FSM}$	30	A
Average forward current			$I_{FAV}$	1.5	A
Junction and storage temperature range			$T_j=T_{stg}$	-55...+150	$^\circ\text{C}$

## Maximum Thermal Resistance

$T_j = 25^\circ\text{C}$

Parameter	Test Conditions	Symbol	Value	Unit
Junction lead	$T_L=\text{constant}$	$R_{thJL}$	25	K/W
Junction ambient	mounted on epoxy-glass hard tissue	$R_{thJA}$	150	K/W
	mounted on epoxy-glass hard tissue, 50mm <sup>2</sup> 35μm Cu	$R_{thJA}$	125	K/W
	mounted on Al-oxid-ceramic (Al <sub>2</sub> O <sub>3</sub> ), 50mm <sup>2</sup> 35μm Cu	$R_{thJA}$	100	K/W

## Electrical Characteristics

$T_j = 25^\circ\text{C}$

Parameter	Test Conditions	Type	Symbol	Min	Typ	Max	Unit
Forward voltage	$I_F=1\text{A}$		$V_F$			900	mV
Reverse current	$V_R=V_{RRM}$		$I_R$			100	μA
	$V_R=V_{RRM}$ , $T_j=100^\circ\text{C}$		$I_R$			1	mA

**Characteristics** ( $T_j = 25^\circ\text{C}$  unless otherwise specified)

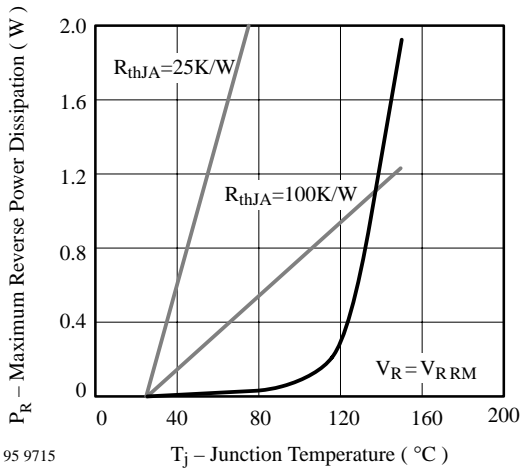

Figure 1. Max. Reverse Power Dissipation vs. Junction Temperature

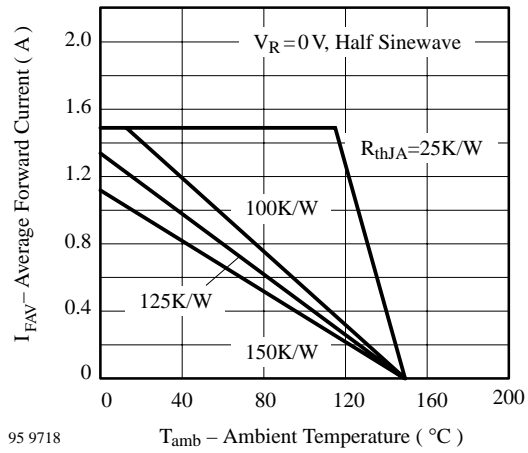

Figure 4. Max. Average Forward Current vs. Ambient Temperature

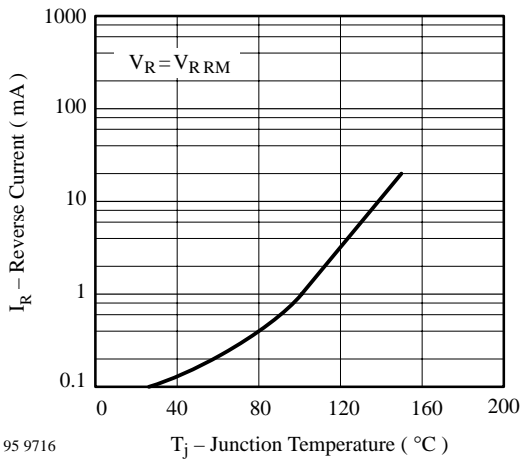

Figure 2. Max. Reverse Current vs. Junction Temperature

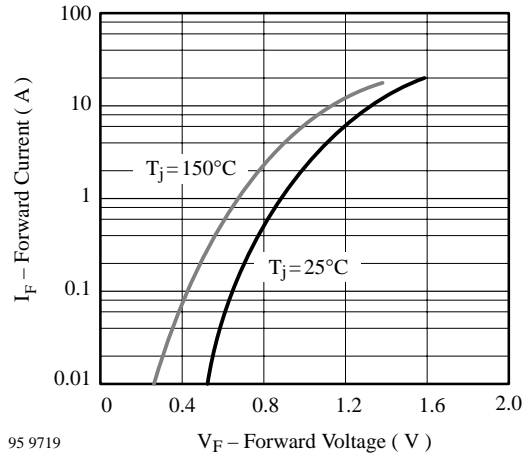

Figure 5. Max. Forward Current vs. Forward Voltage

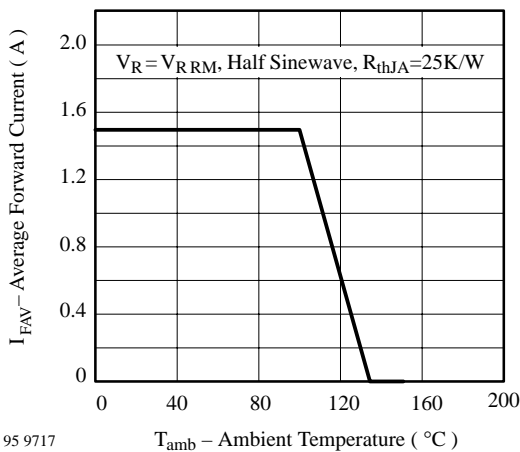
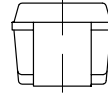
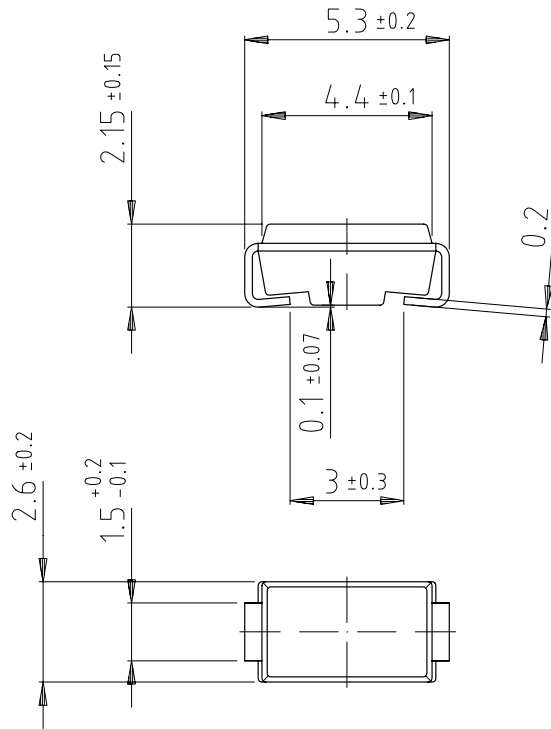
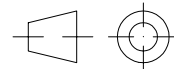

Figure 3. Max. Average Forward Current vs. Ambient Temperature

**Dimensions in mm**



Plastic case JEDEC DO 214  
 similar to SMA  
 Cathode indicated by a band



technical drawings  
 according to DIN  
 specifications

14275



### Ozone Depleting Substances Policy Statement

It is the policy of **Vishay Semiconductor GmbH** to

1. Meet all present and future national and international statutory requirements.
2. Regularly and continuously improve the performance of our products, processes, distribution and operating systems  
with respect to their impact on the health and safety of our employees and the public, as well as their impact on the environment.

It is particular concern to control or eliminate releases of those substances into the atmosphere which are known as ozone depleting substances (ODSs).

The Montreal Protocol (1987) and its London Amendments (1990) intend to severely restrict the use of ODSs and forbid their use within the next ten years. Various national and international initiatives are pressing for an earlier ban on these substances.

**Vishay Semiconductor GmbH** has been able to use its policy of continuous improvements to eliminate the use of ODSs listed in the following documents.

1. Annex A, B and list of transitional substances of the Montreal Protocol and the London Amendments respectively
2. Class I and II ozone depleting substances in the Clean Air Act Amendments of 1990 by the Environmental Protection Agency (EPA) in the USA
3. Council Decision 88/540/EEC and 91/690/EEC Annex A, B and C (transitional substances) respectively.

**Vishay Semiconductor GmbH** can certify that our semiconductors are not manufactured with ozone depleting substances and do not contain such substances.

**We reserve the right to make changes to improve technical design and may do so without further notice.**

Parameters can vary in different applications. All operating parameters must be validated for each customer application by the customer. Should the buyer use Vishay-Telefunken products for any unintended or unauthorized application, the buyer shall indemnify Vishay-Telefunken against all claims, costs, damages, and expenses, arising out of, directly or indirectly, any claim of personal damage, injury or death associated with such unintended or unauthorized use.

Vishay Semiconductor GmbH, P.O.B. 3535, D-74025 Heilbronn, Germany  
Telephone: 49 (0)7131 67 2831, Fax number: 49 (0)7131 67 2423