

Matchable Pairs – Emitter and Detector

Description

Pairs of infrared-emitting diode and phototransistor, matched in their optical and electrical features. These pairs enable a lot of applications. They can be used both for transmissive or reflective sensor functions. The peak wavelength of the emitter is $\lambda = 950 \text{ nm}$.

Applications

- Generally used for industrial processing and controlling, end of tape detector

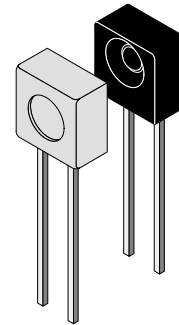

96 12316

Features

- Miniature case with lens
- Detector with optical filter, protected against ambient light
- Detector case black for easy identification of the emitter and detector
- Emitter-angle of half-intensity $\pm \varphi = 35^\circ$
- Detector-angle of half sensitivity $\pm \varphi = 35^\circ$
- Emitter and detector in sideview case
- High CTR $\geq 5\%$

Order Instruction

Ordering Code	Remarks
TCZT8012-PAER	

Absolute Maximum Ratings

Input (Emitter)

Parameter	Test Conditions	Symbol	Value	Unit
Reverse voltage		V_R	6	V
Forward current		I_F	60	mA
Forward surge current	$t_p \leq 10 \mu s$	I_{FSM}	1	A
Power dissipation	$T_{amb} \leq 25^\circ C$	P_V	100	mW
Junction temperature		T_j	100	$^\circ C$

Output (Detector)

Parameter	Test Conditions	Symbol	Value	Unit
Collector emitter voltage		V_{CEO}	70	V
Emitter collector voltage		V_{ECO}	7	V
Collector current		I_C	50	mA
Collector peak current	$t_p/T = 0.5, t_p \leq 10 ms$	I_{CM}	100	mA
Power dissipation	$T_{amb} \leq 25^\circ C$	P_V	150	mW
Junction temperature		T_j	100	$^\circ C$

Coupler

Parameter	Test Conditions	Symbol	Value	Unit
Operating temperature range		T_{amb}	-55 to +85	$^\circ C$
Storage temperature range		T_{stg}	-55 to +100	$^\circ C$
Soldering temperature	2 mm from case, $t \leq 5 s$	T_{sd}	260	$^\circ C$

Electrical Characteristics ($T_{amb} = 25^\circ C$)

Input (Emitter)

Parameter	Test Conditions	Symbol	Min.	Typ.	Max.	Unit
Forward voltage	$I_F = 50 mA$	V_F		1.25	1.6	V
Junction capacitance	$V_R = 0, f = 1 MHz$	C_j		50		pF

Output (Detector)

Parameter	Test Conditions	Symbol	Min.	Typ.	Max.	Unit
Collector emitter voltage	$I_C = 1 mA$	V_{CEO}	70			V
Emitter collector voltage	$I_C = 100 \mu A$	V_{ECO}	7			V
Collector dark current	$V_{CE} = 25 V, I_f = 0, E = 0$	I_{CEO}			100	nA

Emitter and Detector matched ¹⁾

Parameter	Test Conditions	Symbol	Min.	Typ.	Max.	Unit
Collector current	$V_{CE} = 5 V, I_F = 20 mA$	I_C	1	2		mA
I_C / I_F	$V_{CE} = 5 V, I_F = 20 mA$	CTR	0.5	1		mA
Collector emitter saturation voltage	$I_F = 20 mA, I_C = 0.1 mA$	V_{CEsat}			0.4	V
Cut-off frequency	$I_F = 10 mA, V_{CE} = 5 V, R_L = 100 \Omega$	f_C		110		kHz
Coupling capacitance	$f = 1 MHz$	C_k		0.3		pF

¹⁾ Characteristics are measurement at a separation distance of 4 mm (0.55") within a common axis of 0.5 mm (0.02") and parallel within 5°

Switching Characteristics

Parameter	Test Conditions	Symbol	Typ.	Unit
Turn-on time	$V_S = 5\text{ V}$, $I_C = 2\text{ mA}$, $R_L = 100\ \Omega$ (see figure 1)	t_{on}	10.0	μs
Turn-off time		t_{off}	8.0	μs

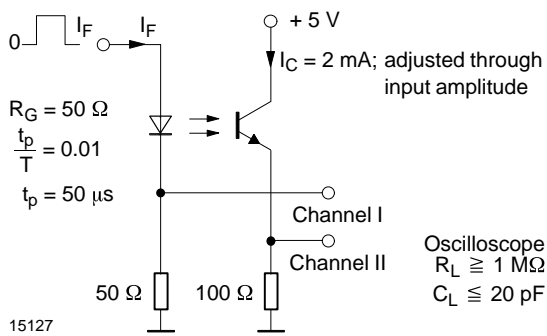

Figure 1. Test circuit

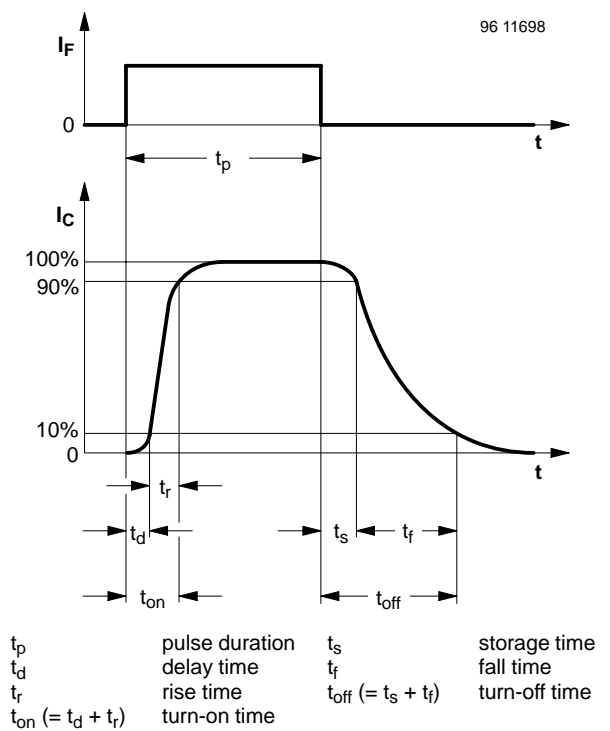

Figure 2. Switching times

Typical Characteristics ($T_{amb} = 25^{\circ}C$, unless otherwise specified)

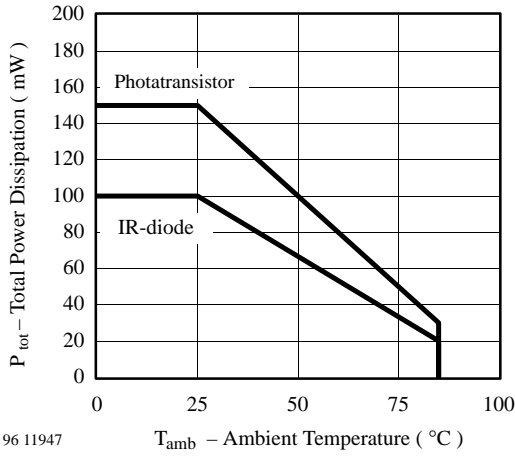

Figure 3. Total Power Dissipation vs. Ambient Temperature

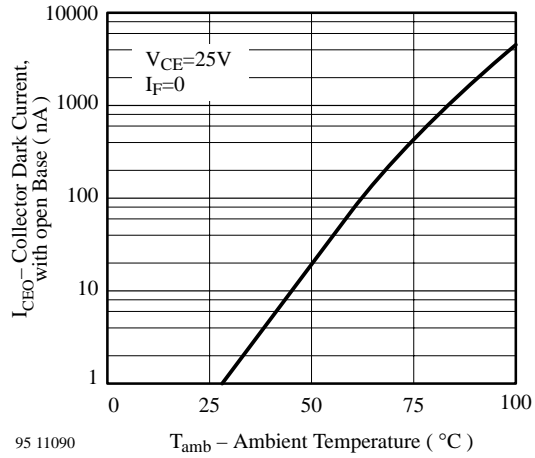

Figure 6. Collector Dark Current vs. Ambient Temperature

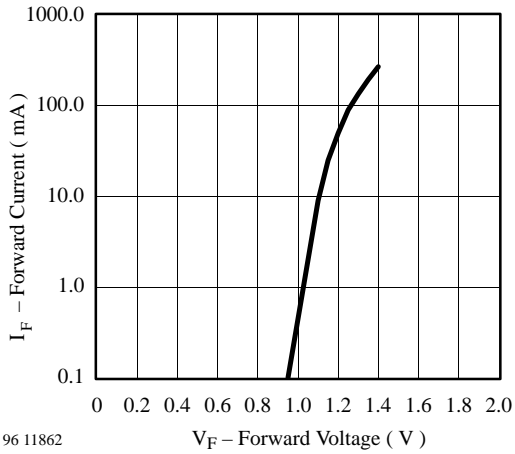

Figure 4. Forward Current vs. Forward Voltage

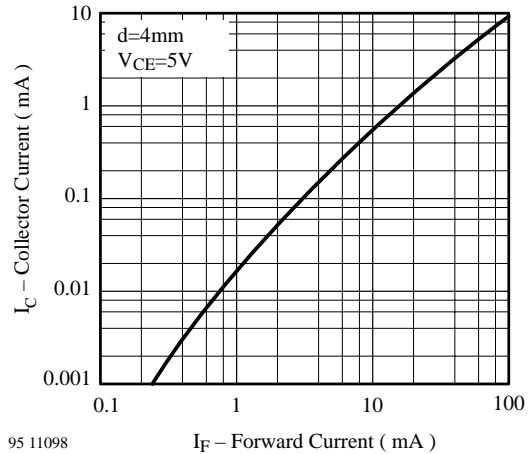

Figure 7. Collector Current vs. Forward Current

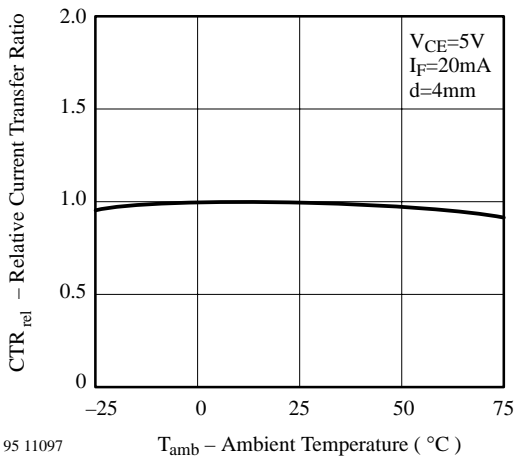

Figure 5. Relative Current Transfer Ratio vs. Ambient Temperature

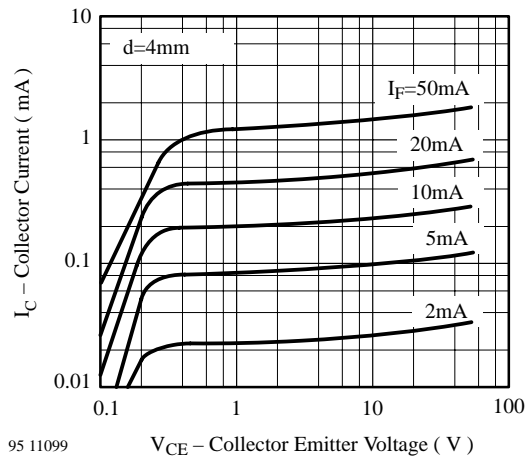

Figure 8. Collector Current vs. Collector Emitter Voltage

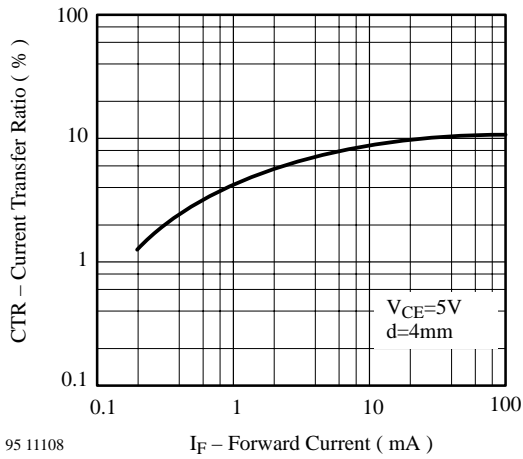

Figure 9. Current Transfer Ratio vs. Forward Current

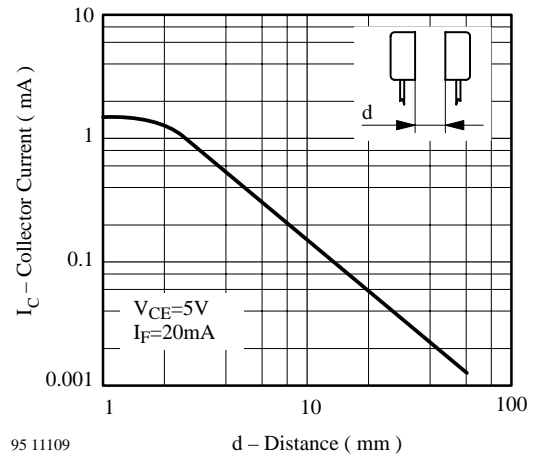

Figure 11. Collector Current vs. Distance

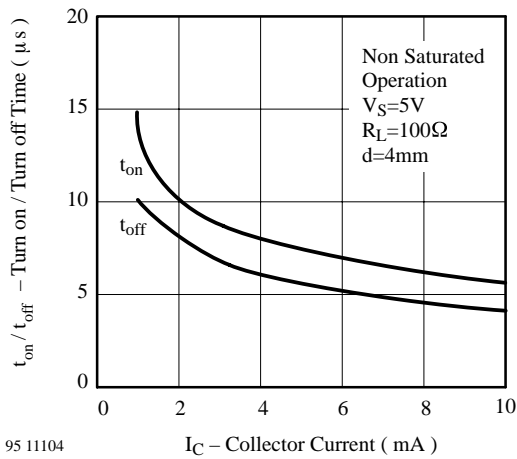

Figure 10. Turn on / off Time vs. Forward Current

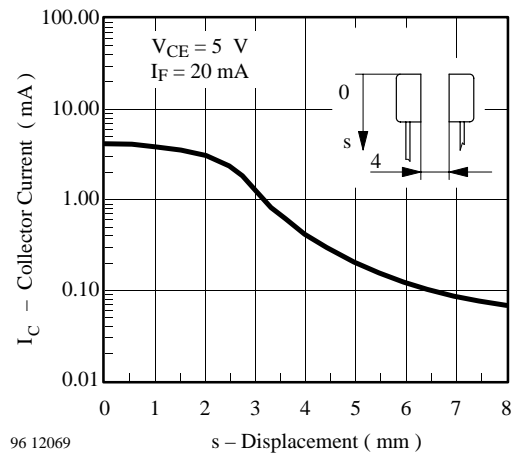

Figure 12. Collector Current vs. Displacement

TCZT8012

Vishay Telefunken



Dimensions of TCZT8012 in mm

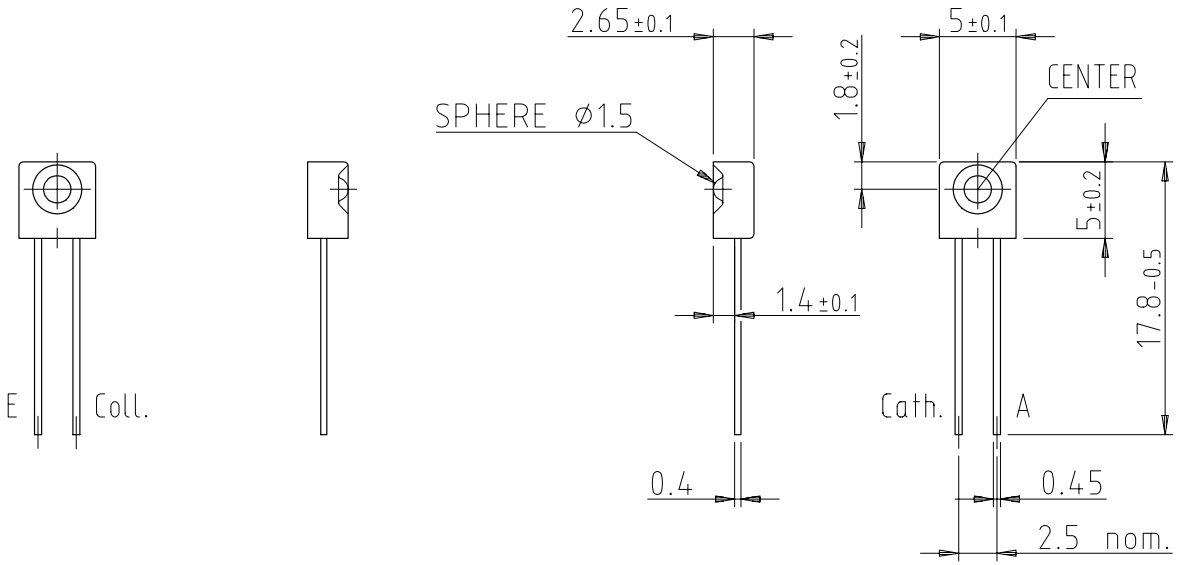

DETECTOR (BLACK)
(MISSING DIM. SEE EMITTER)

EMITTER (CLEAR)

weight: ca. 0.25g

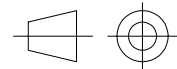

technical drawings
according to DIN
specifications

96 12105



Ozone Depleting Substances Policy Statement

It is the policy of **Vishay Semiconductor GmbH** to

1. Meet all present and future national and international statutory requirements.
2. Regularly and continuously improve the performance of our products, processes, distribution and operating systems with respect to their impact on the health and safety of our employees and the public, as well as their impact on the environment.

It is particular concern to control or eliminate releases of those substances into the atmosphere which are known as ozone depleting substances (ODSs).

The Montreal Protocol (1987) and its London Amendments (1990) intend to severely restrict the use of ODSs and forbid their use within the next ten years. Various national and international initiatives are pressing for an earlier ban on these substances.

Vishay Semiconductor GmbH has been able to use its policy of continuous improvements to eliminate the use of ODSs listed in the following documents.

1. Annex A, B and list of transitional substances of the Montreal Protocol and the London Amendments respectively
2. Class I and II ozone depleting substances in the Clean Air Act Amendments of 1990 by the Environmental Protection Agency (EPA) in the USA
3. Council Decision 88/540/EEC and 91/690/EEC Annex A, B and C (transitional substances) respectively.

Vishay Semiconductor GmbH can certify that our semiconductors are not manufactured with ozone depleting substances and do not contain such substances.

We reserve the right to make changes to improve technical design and may do so without further notice.

Parameters can vary in different applications. All operating parameters must be validated for each customer application by the customer. Should the buyer use Vishay Telefunken products for any unintended or unauthorized application, the buyer shall indemnify Vishay Telefunken against all claims, costs, damages, and expenses, arising out of, directly or indirectly, any claim of personal damage, injury or death associated with such unintended or unauthorized use.

Vishay Semiconductor GmbH, P.O.B. 3535, D-74025 Heilbronn, Germany
Telephone: 49 (0) 7131 67 2831, Fax number: 49 (0) 7131 67 2423