

Surface Mount Schottky Barrier Diodes

Features

- Low Turn-on Voltage
- Fast Switching
- PN Junction Guard Ring for Transient and ESD Protection

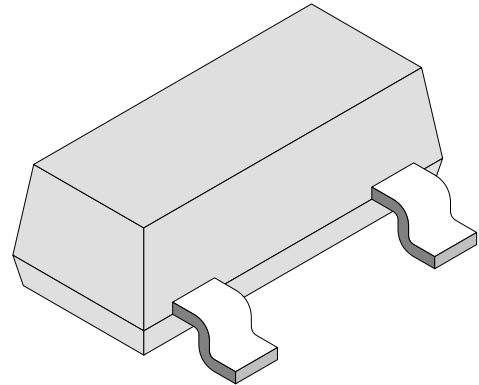

94 8550

Absolute Maximum Ratings

$T_j = 25^\circ\text{C}$

Parameter	Test Conditions	Symbol	Value	Unit
Repetitive peak reverse voltage =Working peak reverse voltage =DC Blocking voltage		V_{RRM} $=V_{RWM}$ $=V_R$	30	V
Peak forward surge current	$t_p < 1\text{s}$, on fiberglass substrate	I_{FSM}	600	mA
Repetitive peak forward current	on fiberglass substrate	I_{FRM}	300	mA
Average forward current		I_{FAV}	100	mA
Forward current	on fiberglass substrate	I_F	200	mA
Power dissipation	on fiberglass substrate	P_d	200	mW
Junction and storage temperature range		$T_j = T_{stg}$	-55...+125	$^\circ\text{C}$

Maximum Thermal Resistance

$T_j = 25^\circ\text{C}$

Parameter	Test Conditions	Symbol	Value	Unit
Junction ambient		R_{thJA}	500	K/W

Electrical Characteristics

$T_j = 25^\circ\text{C}$

Parameter	Test Conditions	Symbol	Min	Typ	Max	Unit
Forward voltage	$I_F=0.1\text{mA}$, $t_p<300\mu\text{s}$, duty cycle $<2\%$	V_F			240	mV
	$I_F=1\text{mA}$, $t_p<300\mu\text{s}$, duty cycle $<2\%$	V_F			320	mV
	$I_F=10\text{mA}$, $t_p<300\mu\text{s}$, duty cycle $<2\%$	V_F			400	mV
	$I_F=30\text{mA}$, $t_p<300\mu\text{s}$, duty cycle $<2\%$	V_F			500	mV
	$I_F=100\text{mA}$, $t_p<300\mu\text{s}$, duty cycle $<2\%$	V_F			1000	mV
Reverse current	$V_R=25\text{V}$, $t_p<300\mu\text{s}$, duty cycle $<2\%$	I_R			2	μA
Breakdown voltage	$I_R=100\mu\text{A}$	$V_{(BR)}$	30			V
Diode capacitance	$V_R=1\text{V}$, $f=1\text{MHz}$	C_D			10	pF
Reverse recovery time	$I_F=10\text{mA}$ through $I_R=10\text{mA}$ to $I_R=1\text{mA}$, $R_L=100\Omega$	t_{rr}			5	ns

Dimensions in mm

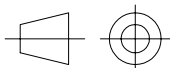
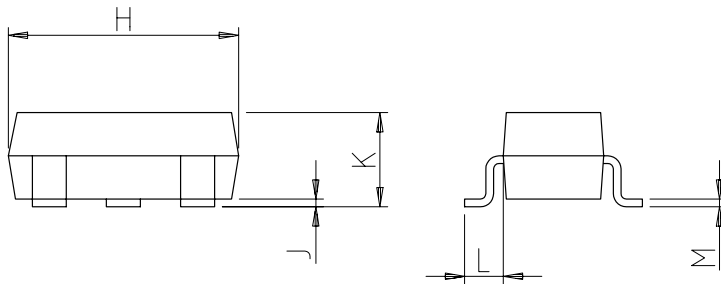

technical drawings
according to DIN
specifications

14384

SOT-23		
Dim	Min	Max
A	0.37	0.50
B	1.19	1.40
C	2.10	2.50
D	0.89	1.05
E	0.45	0.61
G	1.78	2.05
H	2.79	3.05
J	0.013	0.15
K	0.89	1.10
L	0.45	0.61
M	0.076	0.130
All Dimensions in mm		

Case: SOT23, molded plastic

Terminals: Solderable per MIL-STD-202, Method 208

Polarity: see diagrams below

Mounting position: any

Approx. weight: 0.008 grams

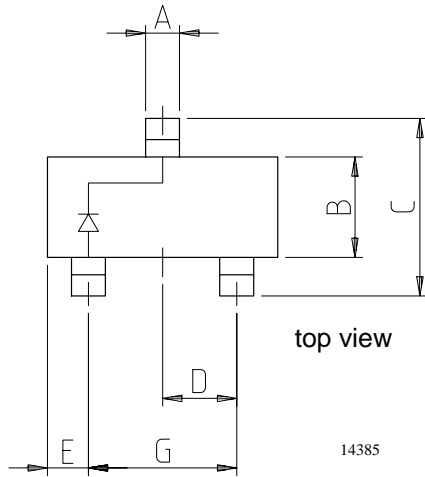

BAT54

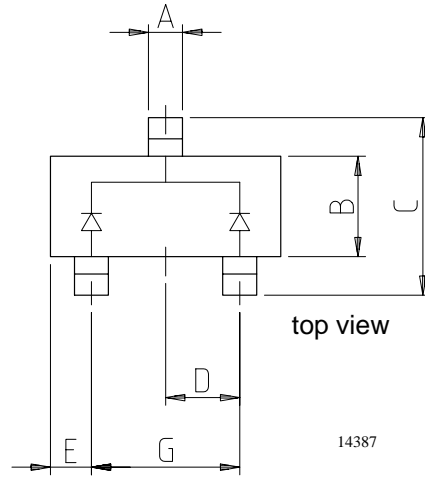

BAT54C, common cathode

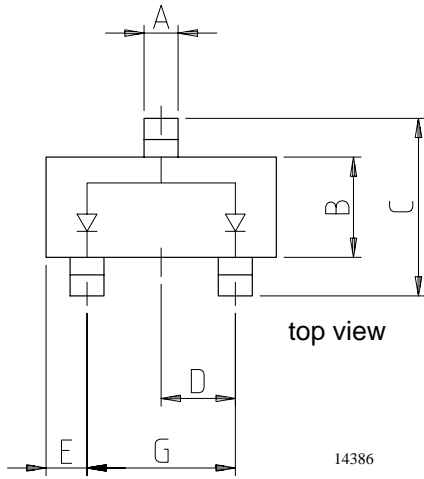

BAT54A, common anode

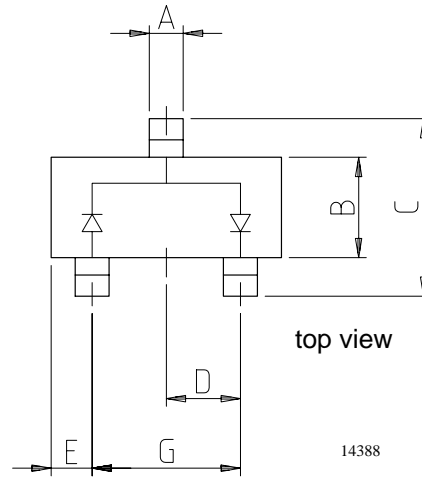

BAT54S, connected in series



Ozone Depleting Substances Policy Statement

It is the policy of **Vishay Semiconductor GmbH** to

1. Meet all present and future national and international statutory requirements.
2. Regularly and continuously improve the performance of our products, processes, distribution and operating systems
with respect to their impact on the health and safety of our employees and the public, as well as their impact on the environment.

It is particular concern to control or eliminate releases of those substances into the atmosphere which are known as ozone depleting substances (ODSs).

The Montreal Protocol (1987) and its London Amendments (1990) intend to severely restrict the use of ODSs and forbid their use within the next ten years. Various national and international initiatives are pressing for an earlier ban on these substances.

Vishay Semiconductor GmbH has been able to use its policy of continuous improvements to eliminate the use of ODSs listed in the following documents.

1. Annex A, B and list of transitional substances of the Montreal Protocol and the London Amendments respectively
2. Class I and II ozone depleting substances in the Clean Air Act Amendments of 1990 by the Environmental Protection Agency (EPA) in the USA
3. Council Decision 88/540/EEC and 91/690/EEC Annex A, B and C (transitional substances) respectively.

Vishay Semiconductor GmbH can certify that our semiconductors are not manufactured with ozone depleting substances and do not contain such substances.

We reserve the right to make changes to improve technical design and may do so without further notice.

Parameters can vary in different applications. All operating parameters must be validated for each customer application by the customer. Should the buyer use Vishay-Telefunken products for any unintended or unauthorized application, the buyer shall indemnify Vishay-Telefunken against all claims, costs, damages, and expenses, arising out of, directly or indirectly, any claim of personal damage, injury or death associated with such unintended or unauthorized use.

Vishay Semiconductor GmbH, P.O.B. 3535, D-74025 Heilbronn, Germany
Telephone: 49 (0) 7131 67 2831, Fax number: 49 (0) 7131 67 2423