

N-Channel Dual Gate MOS-Fieldeffect Tetrode, Depletion Mode

 Electrostatic sensitive device.
Observe precautions for handling.

Applications

Input- and mixer stages especially UHF-tuners.

Features

- Integrated gate protection diodes
- High cross modulation performance
- Low noise figure
- High AGC-range
- Low feedback capacitance
- Low input capacitance

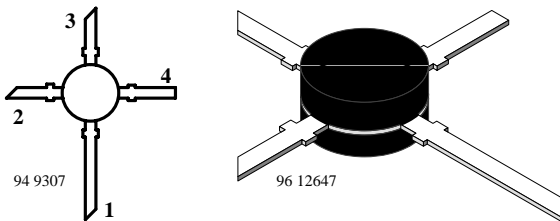

BF966S Marking: BF966S
Plastic case (TO 50)
1=Drain, 2=Source, 3=Gate 1, 4=Gate 2

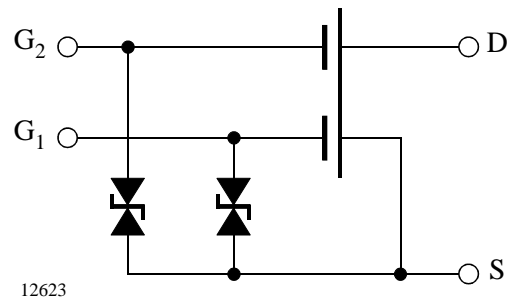

Absolute Maximum Ratings

 $T_{amb} = 25^{\circ}\text{C}$, unless otherwise specified

| Parameter | Test Conditions | Type | Symbol | Value | Unit |
|-------------------------------------|-----------------------------------|------|-------------------|-------------|--------------------|
| Drain - source voltage | | | V_{DS} | 20 | V |
| Drain current | | | I_D | 30 | mA |
| Gate 1/Gate 2 - source peak current | | | $\pm I_{G1/G2SM}$ | 10 | mA |
| Total power dissipation | $T_{amb} \leq 60^{\circ}\text{C}$ | | P_{tot} | 200 | mW |
| Channel temperature | | | T_{Ch} | 150 | $^{\circ}\text{C}$ |
| Storage temperature range | | | T_{stg} | -55 to +150 | $^{\circ}\text{C}$ |

Maximum Thermal Resistance

 $T_{amb} = 25^{\circ}\text{C}$, unless otherwise specified

| Parameter | Test Conditions | Symbol | Value | Unit |
|-----------------|---|-------------|-------|------|
| Channel ambient | on glass fibre printed board (40 x 25 x 1.5) mm ³ plated with 35 μm Cu | R_{thChA} | 450 | K/W |

Electrical DC Characteristics

$T_{amb} = 25^{\circ}\text{C}$, unless otherwise specified

| Parameter | Test Conditions | Type | Symbol | Min | Typ | Max | Unit |
|-----------------------------------|--|---------|--------------------|-----|-----|------|------|
| Drain - source breakdown voltage | $I_D = 10 \mu\text{A}$, $-V_{G1S} = -V_{G2S} = 4 \text{ V}$ | | $V_{(BR)DS}$ | 20 | | | V |
| Gate 1 - source breakdown voltage | $\pm I_{G1S} = 10 \text{ mA}$, $V_{G2S} = V_{DS} = 0$ | | $\pm V_{(BR)G1SS}$ | 8 | | 14 | V |
| Gate 2 - source breakdown voltage | $\pm I_{G2S} = 10 \text{ mA}$, $V_{G1S} = V_{DS} = 0$ | | $\pm V_{(BR)G2SS}$ | 8 | | 14 | V |
| Gate 1 - source leakage current | $\pm V_{G1S} = 5 \text{ V}$, $V_{G2S} = V_{DS} = 0$ | | $\pm I_{G1SS}$ | | | 50 | nA |
| Gate 2 - source leakage current | $\pm V_{G2S} = 5 \text{ V}$, $V_{G1S} = V_{DS} = 0$ | | $\pm I_{G2SS}$ | | | 50 | nA |
| Drain current | $V_{DS} = 15 \text{ V}$, $V_{G1S} = 0$, $V_{G2S} = 4 \text{ V}$ | BF966S | I_{DSS} | 4 | | 18 | mA |
| | | BF966SA | I_{DSS} | 4 | | 10.5 | mA |
| | | BF966SB | I_{DSS} | 9.5 | | 18 | mA |
| Gate 1 - source cut-off voltage | $V_{DS} = 15 \text{ V}$, $V_{G2S} = 4 \text{ V}$, $I_D = 20 \mu\text{A}$ | | $-V_{G1S(OFF)}$ | | | 2.5 | V |
| Gate 2 - source cut-off voltage | $V_{DS} = 15 \text{ V}$, $V_{G1S} = 0$, $I_D = 20 \mu\text{A}$ | | $-V_{G2S(OFF)}$ | | | 2.0 | V |

Electrical AC Characteristics

$V_{DS} = 15 \text{ V}$, $I_D = 10 \text{ mA}$, $V_{G2S} = 4 \text{ V}$, $f = 1 \text{ MHz}$, $T_{amb} = 25^{\circ}\text{C}$, unless otherwise specified

| Parameter | Test Conditions | Symbol | Min | Typ | Max | Unit |
|--------------------------|---|-----------------|-----|------|-----|------|
| Forward transadmittance | | $ y_{21s} $ | 15 | 18.5 | | mS |
| Gate 1 input capacitance | | C_{issg1} | | 2.2 | 2.6 | pF |
| Gate 2 input capacitance | $V_{G1S} = 0$, $V_{G2S} = 4 \text{ V}$ | C_{issg2} | | 1.1 | | pF |
| Feedback capacitance | | C_{rss} | | 25 | 35 | fF |
| Output capacitance | | C_{oss} | | 0.8 | 1.2 | pF |
| Power gain | $G_S = 2 \text{ mS}$, $G_L = 0.5 \text{ mS}$, $f = 200 \text{ MHz}$ | G_{ps} | | 25 | | dB |
| | $G_S = 3,3 \text{ mS}$, $G_L = 1 \text{ mS}$, $f = 800 \text{ MHz}$ | G_{ps} | | 18 | | dB |
| AGC range | $V_{G2S} = 4 \text{ to } -2 \text{ V}$, $f = 800 \text{ MHz}$ | ΔG_{ps} | 40 | | | dB |
| Noise figure | $G_S = 2 \text{ mS}$, $G_L = 0.5 \text{ mS}$, $f = 200 \text{ MHz}$ | F | | 1.0 | | dB |
| | $G_S = 3,3 \text{ mS}$, $G_L = 1 \text{ mS}$, $f = 800 \text{ MHz}$ | F | | 1.8 | | dB |

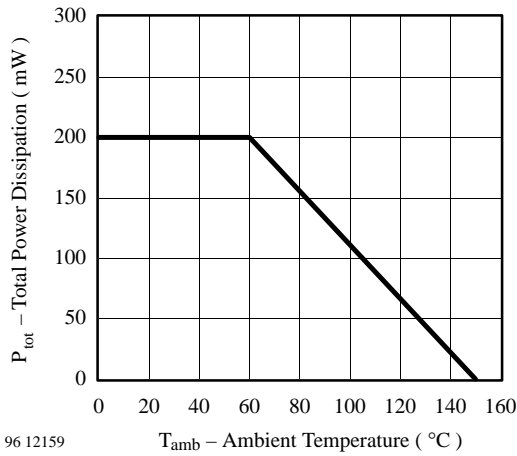
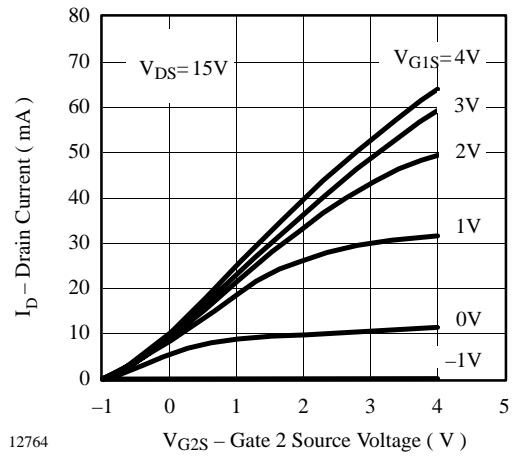
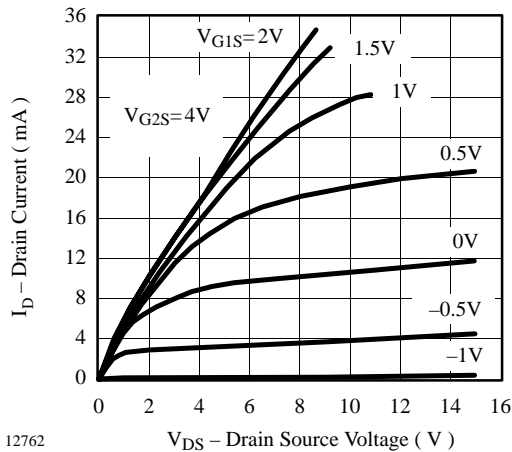
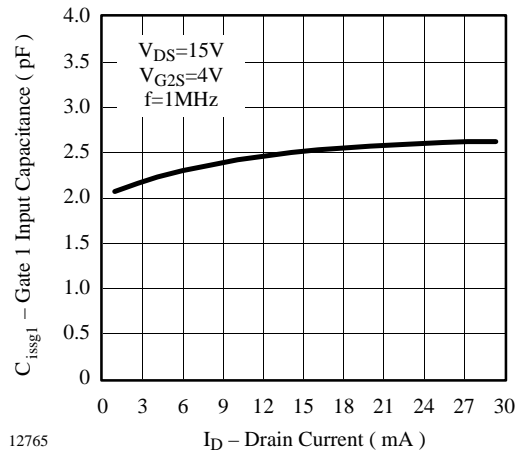
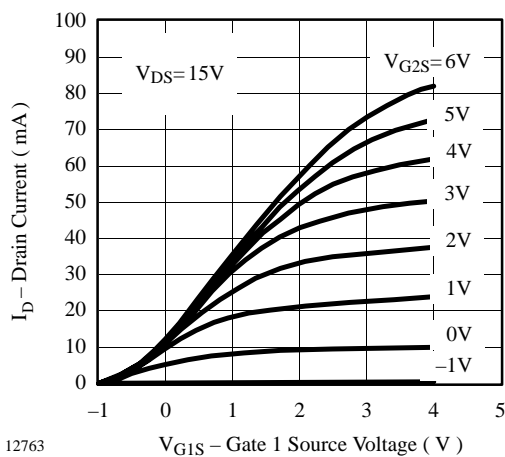
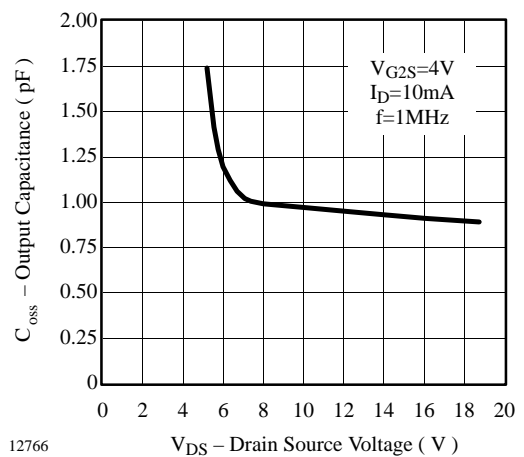
Typical Characteristics ($T_{amb} = 25^{\circ}\text{C}$ unless otherwise specified)

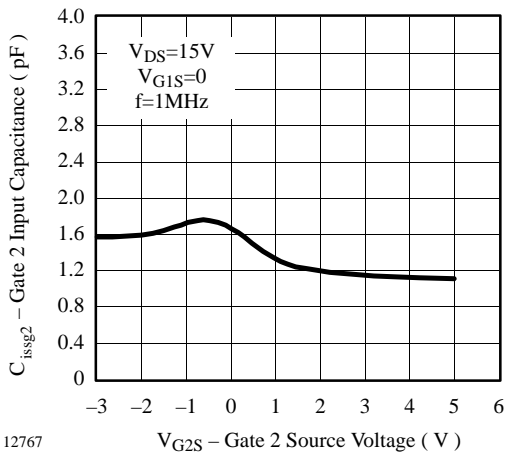
Figure 1. Total Power Dissipation vs. Ambient Temperature

Figure 4. Drain Current vs. Gate 2 Source Voltage

Figure 2. Drain Current vs. Drain Source Voltage

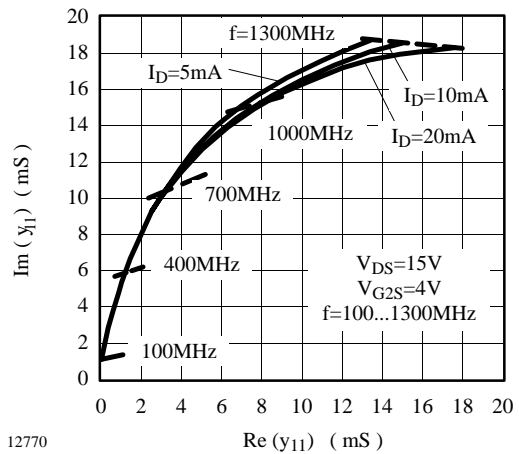
Figure 5. Gate 1 Input Capacitance vs. Drain Current

Figure 3. Drain Current vs. Gate 1 Source Voltage

Figure 6. Output Capacitance vs. Drain Source Voltage



12767

Figure 7. Gate 2 Input Capacitance vs. Gate 2 Source Voltage



12770

Figure 10. Short Circuit Input Admittance

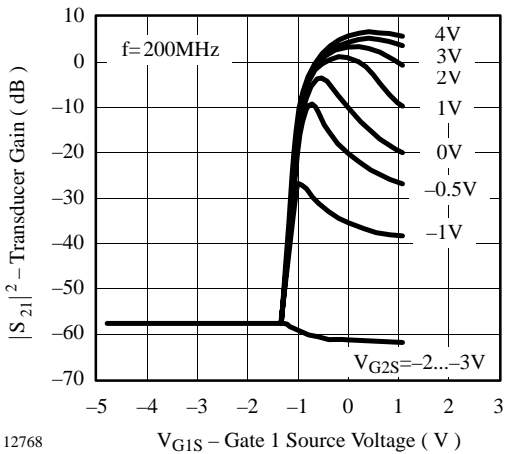

12768

Figure 8. Transducer Gain vs. Gate 1 Source Voltage

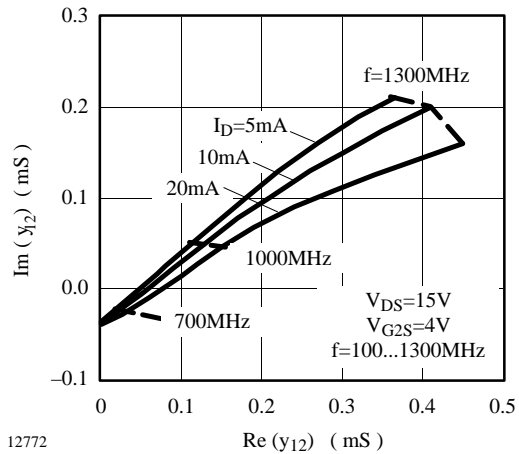

12772

Figure 11. Short Circuit Reverse Transfer Admittance

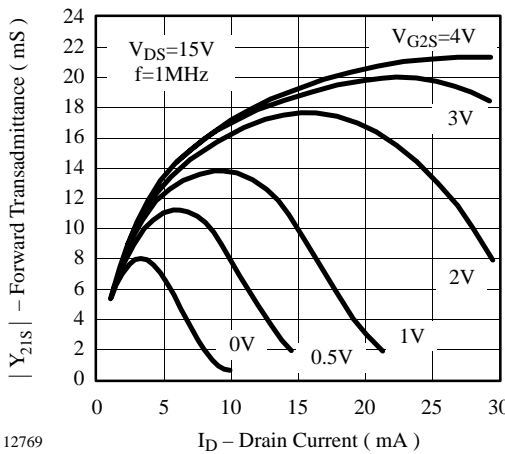

12769

Figure 9. Forward Transadmittance vs. Drain Current

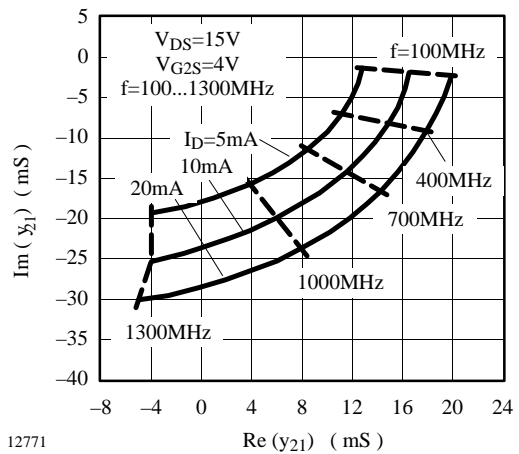

12771

Figure 12. Short Circuit Forward Transfer Admittance

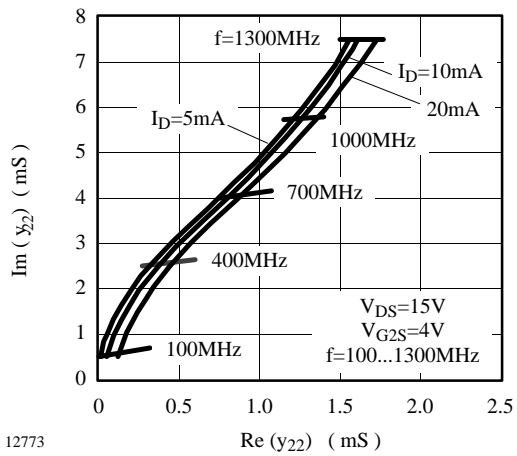

12773

Figure 13. Short Circuit Output Admittance

$V_{DS} = 15 \text{ V}$, $I_D = 5 \text{ to } 20 \text{ mA}$, $V_{G2S} = 4 \text{ V}$, $Z_0 = 50 \Omega$

S_{11}

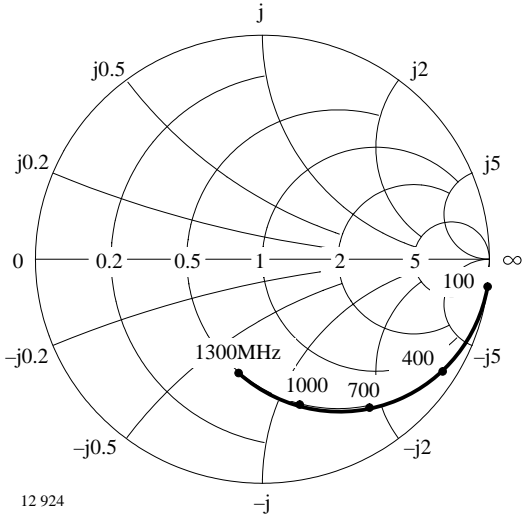

Figure 14. Input reflection coefficient

S_{12}

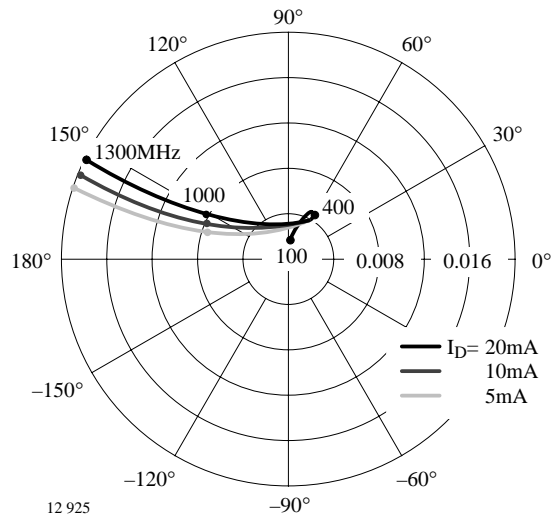

Figure 16. Reverse transmission coefficient

S_{21}

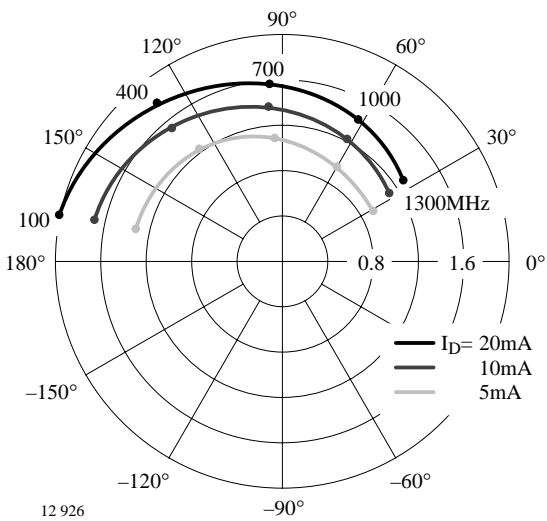

Figure 15. Forward transmission coefficient

S_{22}

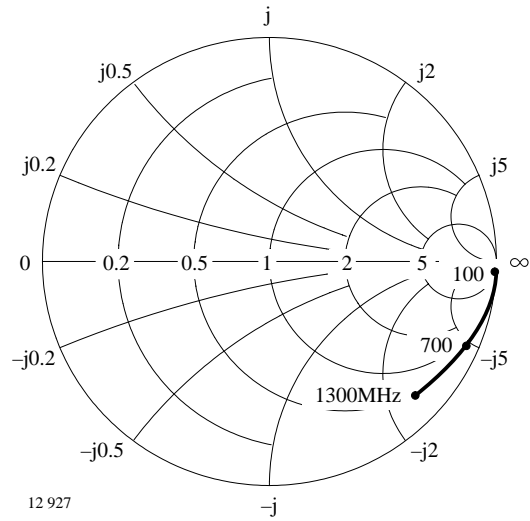
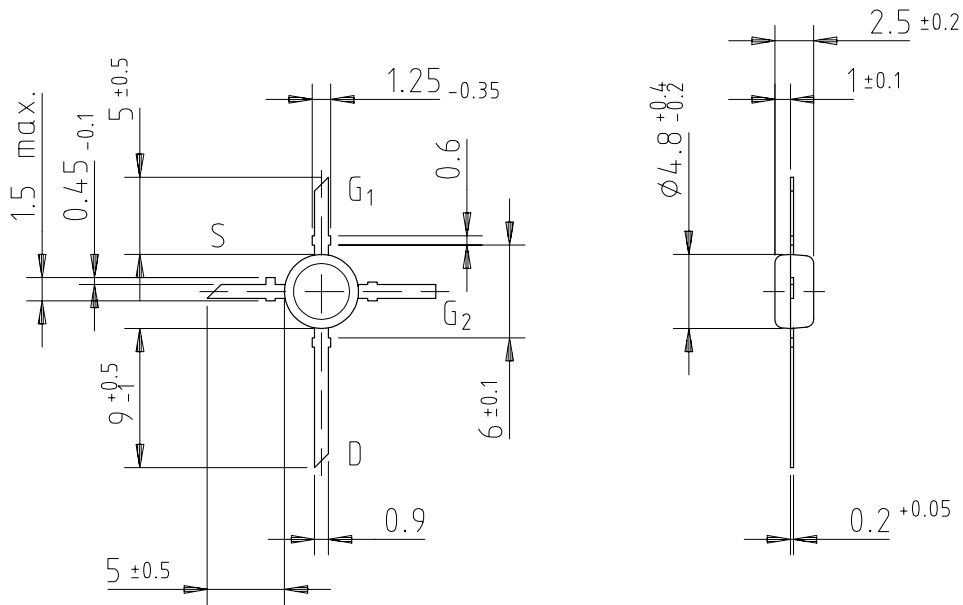
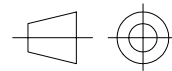

Figure 17. Output reflection coefficient

Dimensions in mm



96 12242



technical drawings
according to DIN
specifications

Ozone Depleting Substances Policy Statement

It is the policy of **Vishay Semiconductor GmbH** to

1. Meet all present and future national and international statutory requirements.
2. Regularly and continuously improve the performance of our products, processes, distribution and operating systems with respect to their impact on the health and safety of our employees and the public, as well as their impact on the environment.

It is particular concern to control or eliminate releases of those substances into the atmosphere which are known as ozone depleting substances (ODSs).

The Montreal Protocol (1987) and its London Amendments (1990) intend to severely restrict the use of ODSs and forbid their use within the next ten years. Various national and international initiatives are pressing for an earlier ban on these substances.

Vishay Semiconductor GmbH has been able to use its policy of continuous improvements to eliminate the use of ODSs listed in the following documents.

1. Annex A, B and list of transitional substances of the Montreal Protocol and the London Amendments respectively
2. Class I and II ozone depleting substances in the Clean Air Act Amendments of 1990 by the Environmental Protection Agency (EPA) in the USA
3. Council Decision 88/540/EEC and 91/690/EEC Annex A, B and C (transitional substances) respectively.

Vishay Semiconductor GmbH can certify that our semiconductors are not manufactured with ozone depleting substances and do not contain such substances.

We reserve the right to make changes to improve technical design and may do so without further notice.

Parameters can vary in different applications. All operating parameters must be validated for each customer application by the customer. Should the buyer use Vishay-Telefunken products for any unintended or unauthorized application, the buyer shall indemnify Vishay-Telefunken against all claims, costs, damages, and expenses, arising out of, directly or indirectly, any claim of personal damage, injury or death associated with such unintended or unauthorized use.

Vishay Semiconductor GmbH, P.O.B. 3535, D-74025 Heilbronn, Germany
Telephone: 49 (0)7131 67 2831, Fax number: 49 (0)7131 67 2423