

Silicon NPN Planar RF Transistor

Electrostatic sensitive device.
Observe precautions for handling. 

Applications

RF amplifier up to 2 GHz, especially for mobile telephone.

Features

- Small feedback capacitance
- Low noise figure
- Low cross modulation

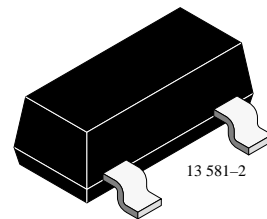
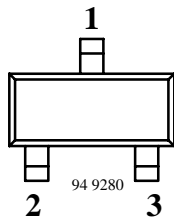

BFQ81 Marking: RA
Plastic case (SOT 23)
1 = Collector, 2 = Base, 3 = Emitter

Absolute Maximum Ratings

$T_{amb} = 25^{\circ}\text{C}$, unless otherwise specified

Parameter	Test Conditions	Symbol	Value	Unit
Collector-base voltage		V_{CBO}	25	V
Collector-emitter voltage		V_{CEO}	16	V
Emitter-base voltage		V_{EBO}	2	V
Collector current		I_C	30	mA
Total power dissipation	$T_{amb} \leq 60^{\circ}\text{C}$	P_{tot}	200	mW
Junction temperature		T_j	150	$^{\circ}\text{C}$
Storage temperature range		T_{stg}	-65 to +150	$^{\circ}\text{C}$

Maximum Thermal Resistance

$T_{amb} = 25^{\circ}\text{C}$, unless otherwise specified

Parameter	Test Conditions	Symbol	Value	Unit
Junction ambient	on glass fibre printed board (25 x 20 x 1.5) mm ³ plated with 35 μm Cu	R_{thJA}	450	K/W

Electrical DC Characteristics

$T_{amb} = 25^{\circ}\text{C}$, unless otherwise specified

Parameter	Test Conditions	Symbol	Min	Typ	Max	Unit
Collector cut-off current	$V_{CE} = 25\text{ V}$, $V_{BE} = 0$	I_{CES}			100	μA
Collector-base cut-off current	$V_{CB} = 20\text{ V}$, $I_E = 0$	I_{CBO}			100	nA
Emitter-base cut-off current	$V_{EB} = 2\text{ V}$, $I_C = 0$	I_{EBO}			10	μA
Collector-emitter breakdown voltage	$I_C = 1\text{ mA}$, $I_B = 0$	$V_{(BR)CEO}$	16			V
Collector-emitter saturation voltage	$I_C = 30\text{ mA}$, $I_B = 3\text{ mA}$	V_{CEsat}		0.2	0.5	V
DC forward current transfer ratio	$V_{CE} = 10\text{ V}$, $I_C = 5\text{ mA}$	h_{FE}	70	100	150	
	$V_{CE} = 10\text{ V}$, $I_C = 15\text{ mA}$	h_{FE}	70	100		

Electrical AC Characteristics

$T_{amb} = 25^{\circ}\text{C}$, unless otherwise specified

Parameter	Test Conditions	Symbol	Min	Typ	Max	Unit
Transition frequency	$V_{CE} = 10\text{ V}$, $I_C = 5\text{ mA}$, $f = 500\text{ MHz}$	f_T		4.2		GHz
	$V_{CE} = 10\text{ V}$, $I_C = 15\text{ mA}$, $f = 500\text{ MHz}$	f_T		5.8		GHz
Collector-base capacitance	$V_{CB} = 10\text{ V}$, $f = 1\text{ MHz}$	C_{cb}		0.35		pF
Collector-emitter capacitance	$V_{CE} = 10\text{ V}$, $f = 1\text{ MHz}$	C_{ce}		0.2		pF
Emitter-base capacitance	$V_{EB} = 0.5\text{ V}$, $f = 1\text{ MHz}$	C_{eb}		1.1		pF
Noise figure	$V_{CE} = 10\text{ V}$, $I_C = 5\text{ mA}$, $Z_S = 50\ \Omega$, $f = 800\text{ MHz}$	F		1.4		dB
	$V_{CE} = 10\text{ V}$, $I_C = 5\text{ mA}$, $Z_S = Z_{Sopt}$, $f = 2\text{ GHz}$	F		2.5		dB
Power gain	$V_{CE} = 10\text{ V}$, $I_C = 5\text{ mA}$, $Z_S = 50\ \Omega$, $Z_L = Z_{Lopt}$, $f = 800\text{ MHz}$	G_{pe}		15		dB
Linear output voltage – two tone intermodulation test	$V_{CE} = 10\text{ V}$, $I_C = 25\text{ mA}$, $d_{IM} = 60\text{ dB}$, $f_1 = 806\text{ MHz}$, $f_2 = 810\text{ MHz}$, $Z_S = Z_L = 50\ \Omega$	$V_1 = V_2$		160		mV
Third order intercept point	$V_{CE} = 10\text{ V}$, $I_C = 25\text{ mA}$, $f = 800\text{ MHz}$	IP_3		27		dBm



Common Emitter S-Parameters

$Z_0 = 50 \Omega$, $T_{amb} = 25^\circ C$, unless otherwise specified

V_{CE}/V	I_C/mA	f/MHz	S11		S21		S12		S22	
			LIN MAG	ANG	LIN MAG	ANG	LIN MAG	ANG	LIN MAG	ANG
				deg		deg		deg		deg
1	2	100	0.868	-29.7	6.78	157.2	0.045	72.3	0.939	-14.2
		300	0.681	-77.6	5.08	125.2	0.098	50.7	0.720	-30.3
		500	0.565	-109.5	3.77	106.3	0.120	42.0	0.576	-35.3
		800	0.491	-142.9	2.67	87.8	0.136	39.4	0.477	-37.3
		1000	0.478	-157.7	2.25	79.1	0.144	40.4	0.447	-38.7
		1200	0.472	-171.0	1.94	71.1	0.152	42.6	0.424	-40.8
		1500	0.480	173.1	1.64	60.8	0.168	46.6	0.399	-45.0
		1800	0.491	159.5	1.42	51.7	0.189	50.6	0.381	-50.4
		2000	0.506	151.7	1.32	46.8	0.208	52.6	0.368	-54.5
		2200	0.523	144.4	1.23	42.1	0.228	53.8	0.355	-59.0
		2500	0.554	133.5	1.13	35.3	0.262	54.3	0.340	-67.3
		2800	0.573	123.9	1.04	29.4	0.294	53.7	0.316	-76.1
3000	0.600	117.4	0.97	26.3	0.315	53.0	0.305	-81.9		
3	2	100	0.882	-24.8	6.74	160.3	0.032	74.9	0.958	-10.0
		300	0.709	-66.7	5.32	130.7	0.073	55.2	0.798	-22.2
		500	0.577	-97.2	4.09	111.8	0.092	46.8	0.680	-26.0
		800	0.477	-130.9	2.96	93.2	0.106	44.4	0.593	-27.9
		1000	0.450	-147.3	2.50	84.6	0.113	46.0	0.569	-29.2
		1200	0.432	-162.0	2.16	76.5	0.120	48.6	0.551	-30.9
		1500	0.433	179.7	1.83	66.4	0.134	53.8	0.531	-34.4
		1800	0.445	164.6	1.58	57.5	0.153	58.9	0.519	-38.5
		2000	0.459	156.0	1.45	52.6	0.169	61.4	0.511	-41.8
		2200	0.471	147.7	1.36	48.1	0.188	63.3	0.502	-45.2
		2500	0.501	136.4	1.24	41.2	0.220	64.8	0.495	-51.5
		2800	0.521	126.5	1.14	35.1	0.252	65.0	0.478	-58.3
	3000	0.543	119.1	1.07	32.2	0.275	64.5	0.471	-63.1	
	5	100	0.741	-38.2	13.66	150.6	0.028	70.6	0.890	-17.2
		300	0.497	-91.6	8.67	116.8	0.056	56.0	0.619	-28.6
		500	0.386	-122.9	5.90	100.7	0.072	55.6	0.504	-27.5
		800	0.332	-153.1	3.94	86.1	0.095	59.4	0.451	-25.3
		1000	0.324	-166.2	3.26	79.4	0.112	61.5	0.439	-25.4
		1200	0.323	-178.8	2.77	72.9	0.130	62.6	0.433	-26.6
		1500	0.333	167.3	2.30	64.6	0.156	63.8	0.422	-29.7
		1800	0.352	155.1	1.98	56.8	0.186	63.9	0.413	-33.7
		2000	0.367	147.8	1.82	52.5	0.206	63.4	0.406	-36.6
		2200	0.381	140.3	1.69	48.5	0.227	62.8	0.398	-39.8
		2500	0.414	131.2	1.54	42.3	0.256	61.4	0.389	-45.7
2800		0.434	123.0	1.41	36.4	0.284	59.8	0.372	-52.0	
3000	0.459	116.9	1.32	33.2	0.303	58.8	0.364	-56.7		



V _{CE} /V	I _C /mA	f/MHz	S11		S21		S12		S22	
			LIN MAG	ANG	LIN MAG	ANG	LIN MAG	ANG	LIN MAG	ANG
				deg		deg		deg		deg
6	2	100	0.887	-23.2	6.76	161.2	0.026	76.4	0.966	-8.3
		300	0.725	-62.5	5.41	132.7	0.061	57.4	0.830	-18.6
		500	0.585	-92.0	4.23	114.0	0.078	49.3	0.728	-22.0
		800	0.473	-125.6	3.08	95.5	0.091	46.9	0.652	-23.7
		1000	0.437	-142.0	2.62	86.9	0.097	48.8	0.630	-24.9
		1200	0.416	-157.2	2.26	78.9	0.103	52.2	0.616	-26.6
		1500	0.410	-177.0	1.91	68.9	0.115	57.8	0.598	-30.0
		1800	0.416	167.2	1.64	59.9	0.133	63.7	0.589	-33.6
		2000	0.428	157.9	1.51	55.0	0.149	66.5	0.585	-36.6
		2200	0.446	149.4	1.41	50.8	0.167	68.9	0.580	-39.6
		2500	0.468	137.2	1.29	43.8	0.197	70.5	0.576	-45.2
		2800	0.492	127.1	1.18	37.6	0.228	71.0	0.562	-51.3
	3000	0.514	119.9	1.10	34.2	0.251	70.7	0.555	-55.4	
	5	100	0.758	-34.7	13.78	152.3	0.023	72.3	0.911	-14.1
		300	0.504	-84.6	9.02	118.9	0.048	57.9	0.675	-23.5
		500	0.378	-114.5	6.20	102.5	0.062	57.5	0.575	-22.6
		800	0.304	-146.3	4.17	87.9	0.083	61.7	0.527	-21.1
		1000	0.293	-160.6	3.44	81.2	0.097	63.8	0.518	-21.6
		1200	0.288	-173.5	2.93	74.8	0.112	65.5	0.513	-22.8
		1500	0.293	170.7	2.44	66.7	0.136	67.0	0.505	-25.9
		1800	0.310	157.4	2.08	59.1	0.163	67.9	0.498	-29.6
		2000	0.328	150.0	1.91	54.8	0.182	67.7	0.494	-32.4
		2200	0.341	142.7	1.79	50.7	0.201	67.4	0.488	-35.2
		2500	0.372	133.4	1.63	44.4	0.229	66.4	0.481	-40.6
		2800	0.397	124.4	1.49	38.3	0.257	64.9	0.463	-46.1
	3000	0.425	118.0	1.39	34.8	0.274	63.9	0.454	-49.6	
	10	100	0.594	-49.3	21.23	142.2	0.020	69.0	0.827	-19.7
		300	0.340	-105.4	11.25	108.9	0.040	63.8	0.558	-23.8
		500	0.262	-134.7	7.21	95.5	0.057	66.7	0.487	-19.8
		800	0.232	-163.7	4.71	83.8	0.084	69.8	0.466	-17.4
		1000	0.226	-174.6	3.85	78.1	0.102	70.8	0.467	-18.0
		1200	0.231	173.7	3.25	72.6	0.121	70.6	0.465	-19.6
		1500	0.243	161.8	2.70	65.3	0.148	69.9	0.461	-23.0
		1800	0.261	150.9	2.31	58.3	0.177	69.1	0.455	-26.8
		2000	0.282	145.1	2.11	54.5	0.197	67.9	0.450	-29.7
		2200	0.296	138.2	1.97	50.7	0.218	66.8	0.442	-32.5
2500		0.326	130.8	1.79	44.8	0.246	64.8	0.434	-37.9	
2800		0.357	122.7	1.64	38.7	0.271	62.7	0.414	-43.0	
3000	0.381	116.8	1.52	35.4	0.287	61.2	0.403	-46.2		



V _{CE} /V	I _C /mA	f/MHz	S11		S21		S12		S22	
			LIN MAG	ANG	LIN MAG	ANG	LIN MAG	ANG	LIN MAG	ANG
				deg		deg		deg		deg
6	20	100	0.415	-68.7	27.88	131.7	0.017	68.66	0.728	-23.6
		300	0.245	-130.0	12.36	101.8	0.036	70.64	0.482	-20.7
		500	0.211	-156.3	7.69	90.9	0.055	73.69	0.445	-15.7
		800	0.203	-179.2	4.93	80.9	0.084	74.84	0.440	-13.9
		1000	0.204	172.3	4.03	75.9	0.105	74.36	0.445	-15.0
		1200	0.209	164.0	3.40	70.8	0.125	73.34	0.447	-17.0
		1500	0.228	154.3	2.81	64.0	0.154	71.71	0.444	-20.8
		1800	0.249	145.7	2.39	57.5	0.184	70.16	0.438	-24.8
		2000	0.266	141.1	2.20	53.7	0.204	68.50	0.432	-27.8
		2200	0.283	136.0	2.04	50.2	0.224	66.99	0.425	-30.7
		2500	0.313	128.2	1.86	44.3	0.253	64.48	0.414	-36.3
		2800	0.344	122.0	1.70	38.3	0.279	61.81	0.390	-41.5
3000	0.381	116.6	1.59	34.2	0.295	59.61	0.374	-44.3		
10	2	100	0.897	-22.3	6.81	161.7	0.023	76.6	0.970	-7.4
		300	0.732	-60.6	5.50	133.6	0.055	58.4	0.849	-16.7
		500	0.589	-89.4	4.31	114.9	0.070	50.3	0.753	-19.7
		800	0.465	-122.9	3.16	96.5	0.081	48.8	0.686	-21.4
		1000	0.430	-139.4	2.67	88.0	0.087	50.9	0.667	-22.7
		1200	0.403	-155.1	2.31	79.9	0.093	54.6	0.654	-24.2
		1500	0.396	-175.1	1.95	70.1	0.105	60.8	0.641	-27.2
		1800	0.398	168.9	1.68	61.3	0.122	66.9	0.634	-30.8
		2000	0.411	159.6	1.55	56.5	0.137	70.0	0.630	-33.5
		2200	0.426	150.5	1.45	52.0	0.155	72.5	0.628	-36.6
		2500	0.454	137.9	1.32	44.9	0.184	74.4	0.626	-41.9
		2800	0.480	128.4	1.21	38.6	0.215	74.8	0.611	-47.7
	3000	0.507	121.3	1.13	34.5	0.237	73.9	0.598	-51.7	
	5	100	0.774	-33.0	13.72	153.0	0.021	72.8	0.921	-12.4
		300	0.515	-80.6	9.14	120.0	0.044	59.0	0.709	-20.6
		500	0.379	-110.1	6.31	103.3	0.056	58.2	0.617	-19.9
		800	0.298	-141.4	4.24	88.7	0.075	62.7	0.577	-18.9
		1000	0.278	-156.2	3.51	82.1	0.088	65.4	0.569	-19.5
		1200	0.269	-170.2	2.98	75.7	0.102	67.3	0.564	-20.8
		1500	0.275	173.1	2.48	67.7	0.123	69.2	0.559	-23.8
		1800	0.288	159.7	2.12	60.1	0.148	70.5	0.554	-27.4
		2000	0.306	151.4	1.95	55.9	0.166	70.7	0.551	-30.0
		2200	0.322	143.9	1.82	51.9	0.184	70.7	0.547	-32.6
		2500	0.349	134.8	1.65	45.6	0.211	70.0	0.541	-37.9
2800		0.377	126.0	1.52	39.3	0.239	68.7	0.524	-43.2	
3000	0.408	119.5	1.42	35.2	0.257	67.4	0.512	-46.5		

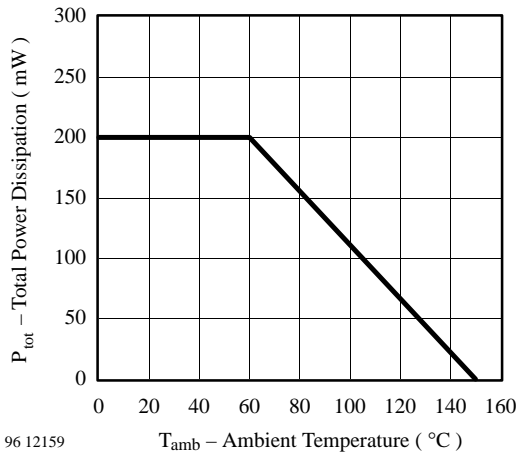
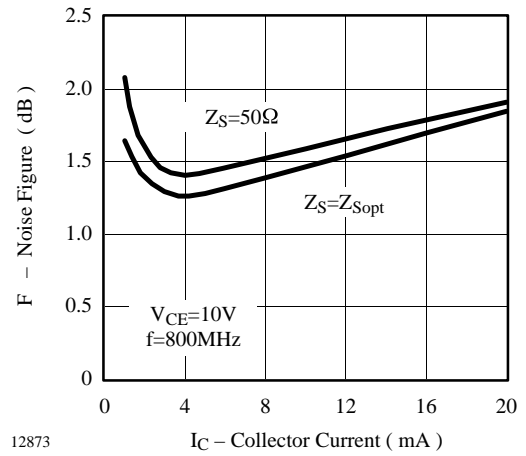
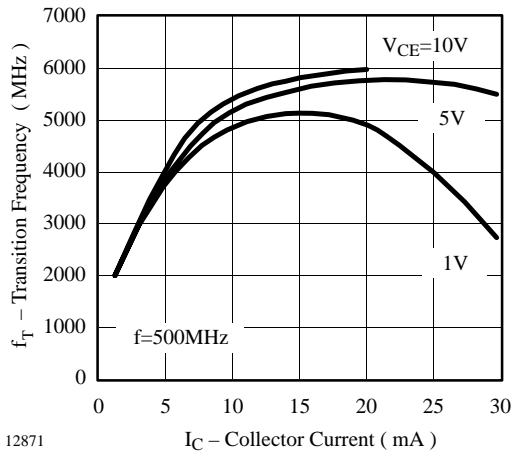
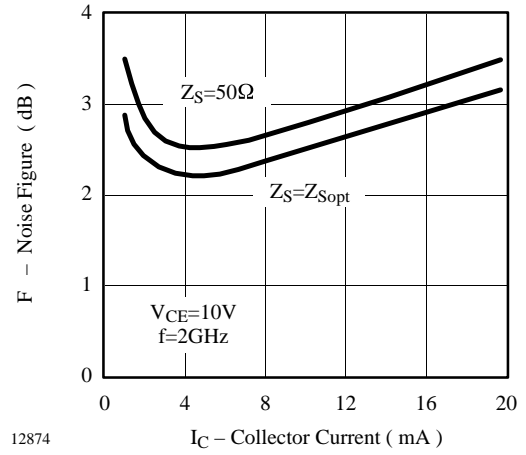
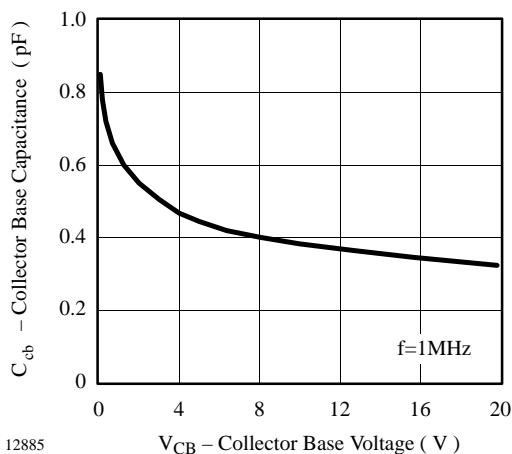

V _{CE} /V	I _C /mA	f/MHz	S11		S21		S12		S22	
			LIN MAG	ANG	LIN MAG	ANG	LIN MAG	ANG	LIN MAG	ANG
				deg		deg		deg		deg
10	10	100	0.625	-45.8	21.09	143.5	0.018	70.0	0.851	-16.9
		300	0.349	-99.0	11.39	109.9	0.037	63.8	0.605	-20.5
		500	0.259	-127.9	7.34	96.4	0.052	67.2	0.541	-17.1
		800	0.215	-157.9	4.79	84.5	0.075	70.7	0.523	-15.7
		1000	0.208	-170.0	3.92	79.0	0.092	71.8	0.524	-16.5
		1200	0.209	176.9	3.32	73.5	0.109	72.0	0.523	-18.0
		1500	0.222	163.8	2.75	66.3	0.134	71.9	0.520	-21.2
		1800	0.241	152.4	2.34	59.4	0.161	71.6	0.517	-24.9
		2000	0.256	145.9	2.15	55.5	0.180	70.7	0.514	-27.7
		2200	0.275	139.7	2.01	51.9	0.198	69.6	0.508	-30.6
		2500	0.304	131.6	1.82	45.8	0.225	68.4	0.502	-35.6
		2800	0.332	123.7	1.68	39.5	0.252	66.3	0.481	-40.7
	3000	0.364	118.7	1.56	65.7	0.268	64.6	0.467	-43.8	
	20	100	0.465	-63.2	27.66	133.0	0.015	68.1	0.762	-20.1
		300	0.249	-121.5	12.49	102.6	0.033	70.3	0.541	-17.3
		500	0.201	-148.9	7.77	91.7	0.050	73.6	0.509	-13.6
		800	0.189	-174.5	4.99	81.4	0.076	75.2	0.506	-12.7
		1000	0.188	175.6	4.07	76.6	0.094	75.3	0.511	-13.9
		1200	0.189	166.4	3.44	71.5	0.112	74.7	0.511	-15.9
		1500	0.206	155.9	2.84	65.0	0.138	73.7	0.510	-19.4
		1800	0.226	147.1	2.42	58.4	0.165	72.6	0.507	-23.3
		2000	0.244	141.7	2.22	54.7	0.184	71.4	0.504	-26.2
		2200	0.264	135.4	2.07	51.0	0.203	70.3	0.499	-28.9
		2500	0.297	128.6	1.88	45.2	0.230	68.4	0.492	-34.3
2800		0.322	123.2	1.73	39.3	0.257	66.0	0.470	-39.5	
3000	0.351	118.2	1.61	35.3	0.274	64.2	0.453	-42.8		

Typical Characteristics ($T_{amb} = 25^{\circ}\text{C}$ unless otherwise specified)

Figure 1. Total Power Dissipation vs. Ambient Temperature

Figure 4. Noise Figure vs. Collector Current

Figure 2. Transition Frequency vs. Collector Current

Figure 5. Noise Figure vs. Collector Current

Figure 3. Collector Base Capacitance vs. Collector Base Voltage

$V_{CE} = 10 \text{ V}$, $I_C = 10 \text{ mA}$, $Z_0 = 50 \Omega$

S_{11}

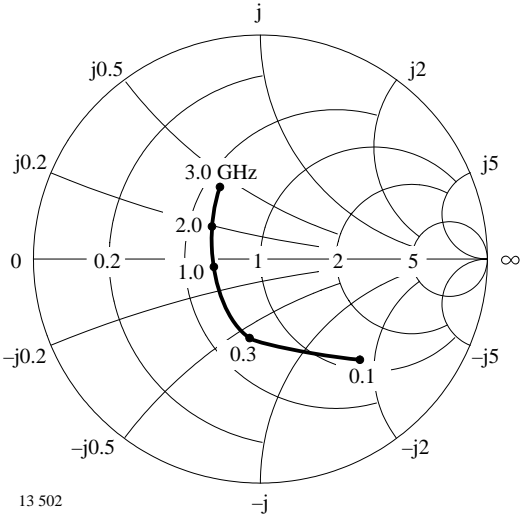

Figure 6. Input reflection coefficient

S_{12}

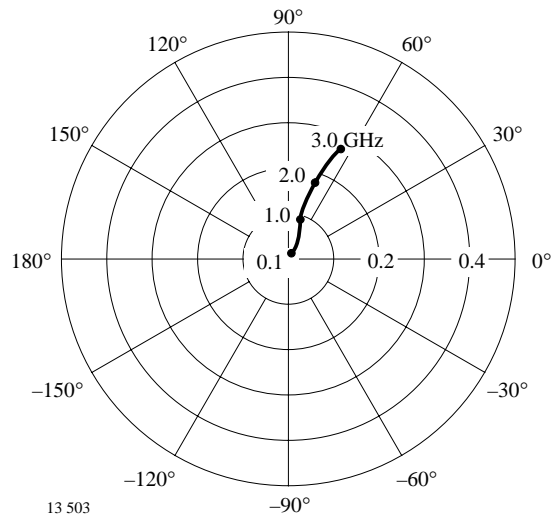

Figure 8. Reverse transmission coefficient

S_{21}

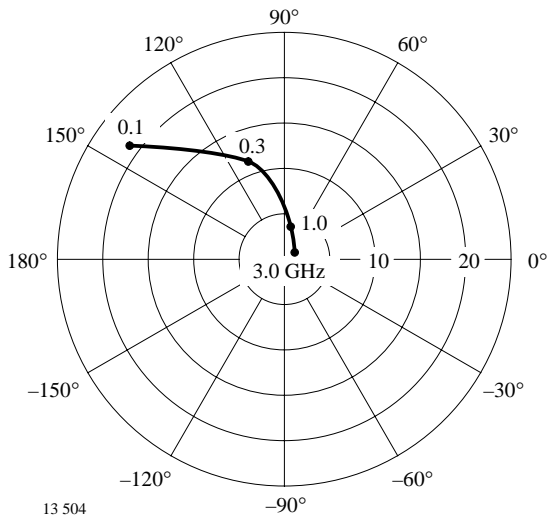

Figure 7. Forward transmission coefficient

S_{22}

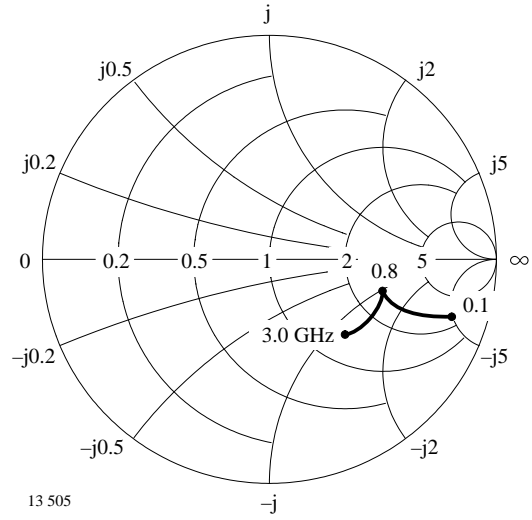
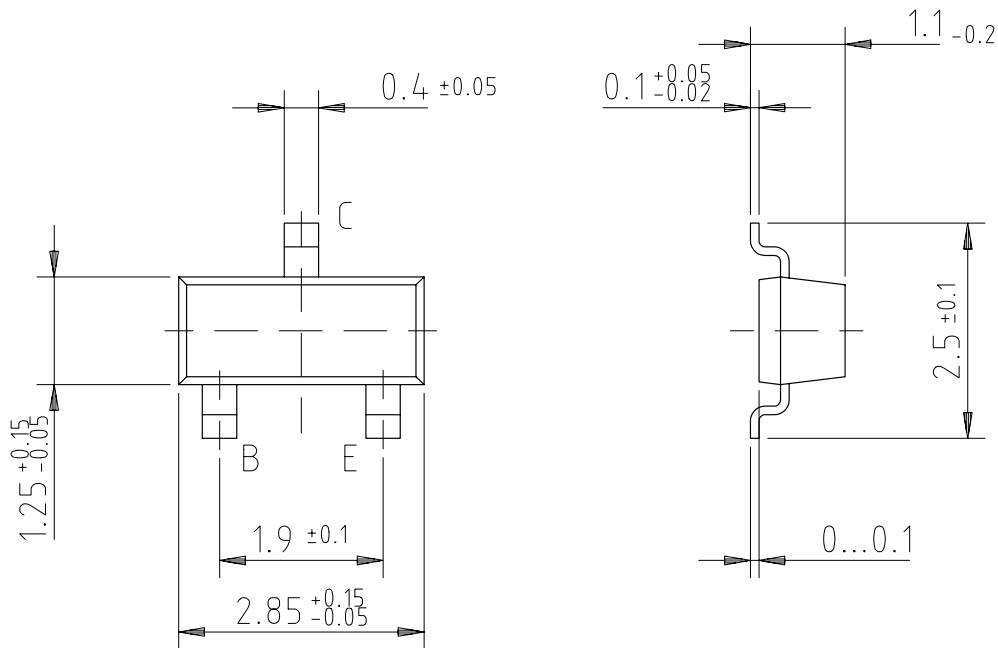
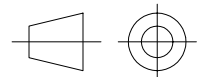

Figure 9. Output reflection coefficient

Dimensions of BFQ81 in mm



95 11346



technical drawings
according to DIN
specifications

Ozone Depleting Substances Policy Statement

It is the policy of **Vishay Semiconductor GmbH** to

1. Meet all present and future national and international statutory requirements.
2. Regularly and continuously improve the performance of our products, processes, distribution and operating systems with respect to their impact on the health and safety of our employees and the public, as well as their impact on the environment.

It is particular concern to control or eliminate releases of those substances into the atmosphere which are known as ozone depleting substances (ODSs).

The Montreal Protocol (1987) and its London Amendments (1990) intend to severely restrict the use of ODSs and forbid their use within the next ten years. Various national and international initiatives are pressing for an earlier ban on these substances.

Vishay Semiconductor GmbH has been able to use its policy of continuous improvements to eliminate the use of ODSs listed in the following documents.

1. Annex A, B and list of transitional substances of the Montreal Protocol and the London Amendments respectively
2. Class I and II ozone depleting substances in the Clean Air Act Amendments of 1990 by the Environmental Protection Agency (EPA) in the USA
3. Council Decision 88/540/EEC and 91/690/EEC Annex A, B and C (transitional substances) respectively.

Vishay Semiconductor GmbH can certify that our semiconductors are not manufactured with ozone depleting substances and do not contain such substances.

We reserve the right to make changes to improve technical design and may do so without further notice.

Parameters can vary in different applications. All operating parameters must be validated for each customer application by the customer. Should the buyer use Vishay-Telefunken products for any unintended or unauthorized application, the buyer shall indemnify Vishay-Telefunken against all claims, costs, damages, and expenses, arising out of, directly or indirectly, any claim of personal damage, injury or death associated with such unintended or unauthorized use.

Vishay Semiconductor GmbH, P.O.B. 3535, D-74025 Heilbronn, Germany
Telephone: 49 (0)7131 67 2831, Fax number: 49 (0)7131 67 2423