



TBA 810 S · TBA 810 AS

Monolithisch Integrierte Schaltung Monolithic Integrated Circuit

Anwendung: NF-Leistungsverstärker
Application: Audio power amplifier

Besondere Merkmale:

- Thermische Abschaltung
- Hoher Ausgangsstrom bis 2,5 A
- Großer Versorgungsspannungsbereich, 4 bis 20 V
- Hohe Ausgangsleistung, 7 W
- Kleine Übernahmeverzerrungen
- Kleiner Klirrfaktor
- Sehr guter Wirkungsgrad, 70%

Features:

- Thermal shut-down
- High output current, up to 2.5 A
- Wide range of supply voltage, 4 to 20 V
- High output power 7 W
- Low harmonic distortion
- Low cross over distortion
- Very high efficiency 70%

Vorläufige technische Daten · Preliminary specifications

Abmessungen in mm
Dimensions in mm

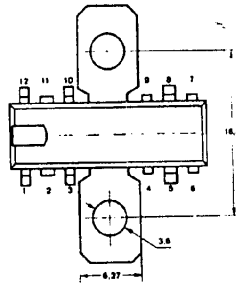
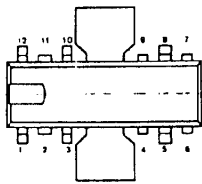
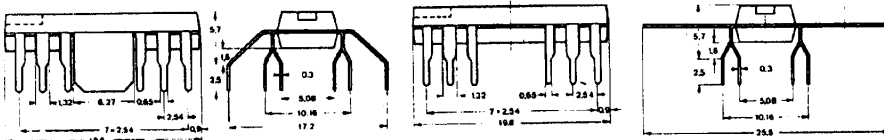

Spezialgehäuse
Kunststoff
Special case
Plastic
Gewicht · Weight
max. 1,5 g

TBA 810 S

TBA 810 AS

TBA 810 S · TBA 810 AS

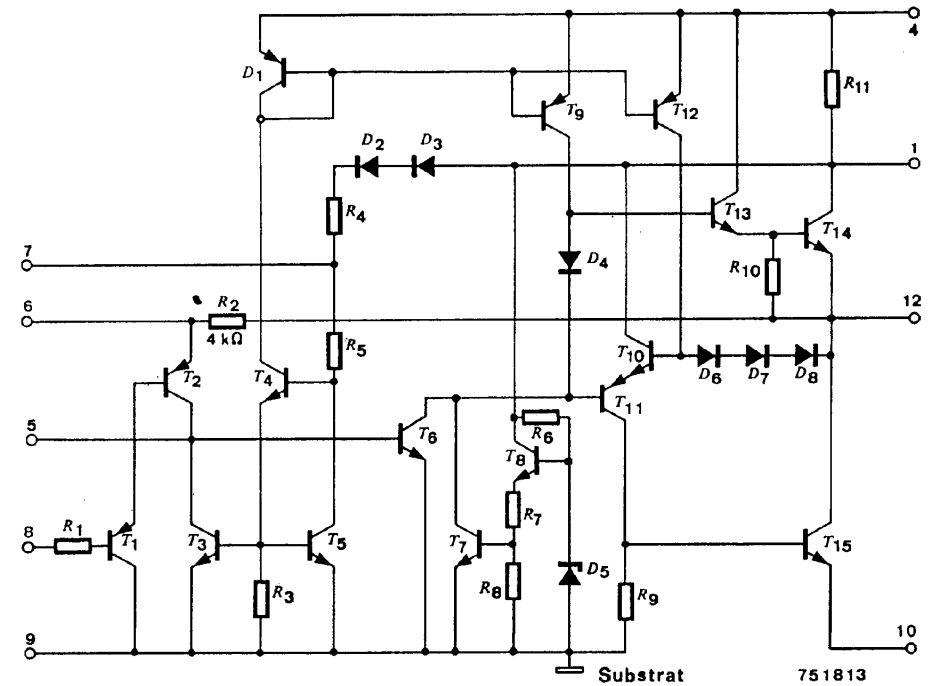

Fig. 1 Schaltung und Anschlußbelegung
Diagram and pin connections

Absolute Grenzwerte Absolute maximum ratings

Bezugspunkt Pin 9, Pin 10
Reference point

Versorgungsspannung Supply voltage	Pin 1	U_S	20	V
Ausgangsstoßstrom Surge output current	Pin 12	I_{QS}	3,5	A
Ausgangsspitzenstrom Peak output current (repetitive)	Pin 12	I_{QM}	2,5	A
Verlustleistung Power dissipation	Fig. 2, 3, 4, 5, 6			
$t_{amb} = 80^\circ\text{C}$	TBA 810 S	P_{tot}	1	W
$t_{case} = 100^\circ\text{C}$	TBA 810 AS	P_{tot}	5	W
Sperrschichttemperatur Junction temperature		t_j	+150	$^\circ\text{C}$
Lagerungstemperaturbereich Storage temperature range		t_{stg}	-40 ... +150	$^\circ\text{C}$

TBA 810 S · TBA 810 AS

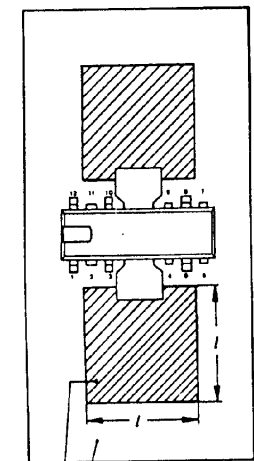
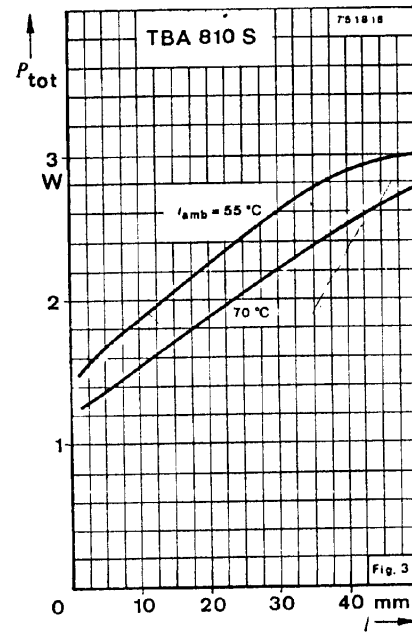
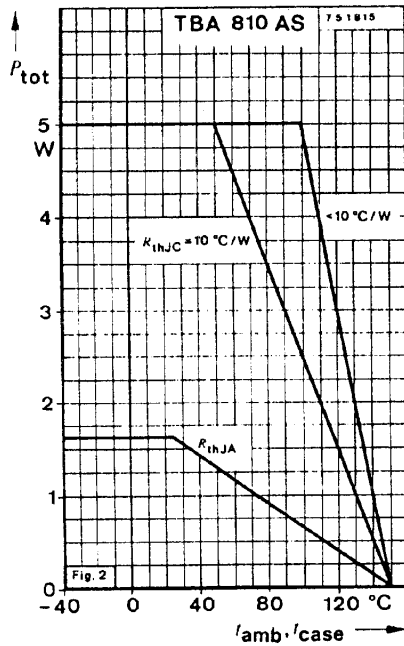

Kupferfläche 35 μm dick
Copper area 35 μm thickness

Fig. 4

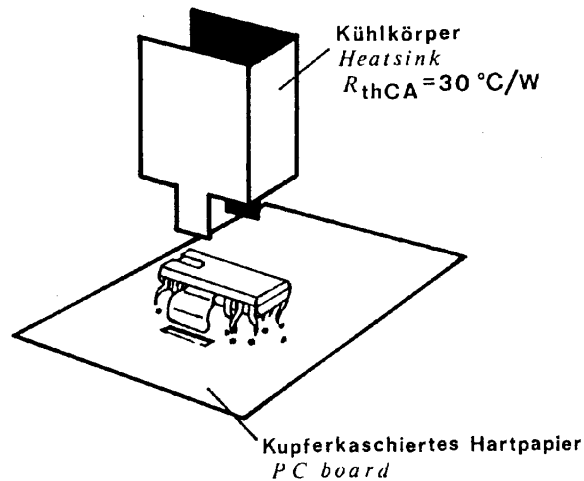

Fig. 5

TBA 810 S · TBA 810 AS

Wärmewiderstände Thermal resistances

		Min.	Typ.	Max.
Sperrschicht-Umgebung Junction ambient	TBA 810 S TBA 810 AS	R_{thJA}		70 $^\circ\text{C/W}$ 80 $^\circ\text{C/W}$
Sperrschicht-Gehäuse Fig. 3, 4, 5 Junction case	TBA 810 S TBA 810 AS	$R_{thJC}^{1)}$ $R_{thJC}^{1)}$		12 $^\circ\text{C/W}$ 10 $^\circ\text{C/W}$

Elektrische Kenngrößen Electrical characteristics

$t_{amb} = 25 \text{ }^\circ\text{C}$, $R_f = 56 \ \Omega$, Bezugspunkt: Pin 9, Pin 10 falls nicht anders angegeben
Reference point: unless otherwise specified

Versorgungsspannung Supply voltage	Pin 1	U_S	4	20	V		
Mittenspannung Quiescent output voltage $U_S = 14,4 \text{ V}$	Fig. 13	Pin 12	U_{QB}	6,4	7,2	8	V
Ruhestrom der Gesamtschaltung Quiescent drain current $U_S = 14,4 \text{ V}$	Fig. 12	Pin 1	I_{SB}	12	20	mA	
Gesamtstromaufnahme Total supply current $P_q = 6 \text{ W}$, $U_S = 14,4 \text{ V}$, $R_L = 4 \ \Omega$		Pin 1	$I_{S \text{ tot}}$	600		mA	
Thermische Abschalttemperatur Thermal shut-down temperature $P_{tot} = 2,8 \text{ W}$	Fig. 11		t_{case}	120		$^\circ\text{C}$	
Brummunterdrückung Supply voltage rejection ratio $U_S = 14,4 \text{ V}$, $R_L = 4 \ \Omega$, $f_{Br} = 100 \text{ Hz}$	Fig. 14, 15		k_{SVR}	48		dB	
Eingangsstrom Input current $U_S = 14,4 \text{ V}$		Pin 8	I_{IB}	0,4	4	μA	
Ausgangsleistung Output power $R_L = 4 \ \Omega$, $f = 1 \text{ kHz}$, $k = 10\%$	Fig. 6, 8, 9, 10, 11		P_q	7		W	
			P_q	4,6	6	W	
			P_q	2,5		W	
			P_q	1		W	
Eingangsspannung Input voltage		Pin 8	U_i		220	mV	
Eingangsspannung Input voltage $U_S = 14,4 \text{ V}$, $P_q = 6 \text{ W}$, $f = 1 \text{ kHz}$, $R_L = 4 \ \Omega$	Fig. 18	Pin 8	U_i	80		mV	
			U_i	35		mV	

¹⁾ mit Kühlfläche $R_{thCA} = 10 \text{ }^\circ\text{C/W}$
with cooling plate

TBA 810 S · TBA 810 AS

	Pin 8	R_i	Min.	Typ.	Max.	
Eingangswiderstand Input resistance				5		M Ω
Bandbreite (-3 dB) Band width	Fig. 16	B	40 ...	20000		Hz
$U_S = 14,4 \text{ V}, R_L = 4 \Omega, C_3 = 820 \text{ pF}$ $C_3 = 1500 \text{ pF}$		B	40 ...	10000		Hz
Klirrfaktor Distortion	Fig. 6, 19, 20	k		0,3		%
$U_S = 14,4 \text{ V}, R_L = 4 \Omega,$ $f = 1 \text{ kHz}, P_q = 50 \text{ mW bis/to } 3 \text{ W}$						
Spannungsverstärkungen Voltage amplifications		A_{Ug}		80		dB
$U_S = 14,4 \text{ V}, R_L = 4 \Omega, f = 1 \text{ kHz}$						
Leerlauf Open loop		A_{Uf}	34	37	40	dB
mit Gegenkopplung closed loop	Fig. 17					
Eingangsrauschspannung Input noise voltage		U_{ni}		2		μV
$U_S = 14,4 \text{ V}, B = 20 \dots 20000 \text{ Hz}$	Pin 8					
Eingangsrauschstrom Input noise current		I_{ni}		0,1		nA
$U_S = 14,4 \text{ V}, B = 20 \dots 20000 \text{ Hz}$	Pin 8					
Wirkungsgrad Efficiency	Fig. 6, 9	η		70		%
$P_q = 5 \text{ W}, U_S = 14,4 \text{ V},$ $R_L = 4 \Omega, f = 1 \text{ kHz}$						

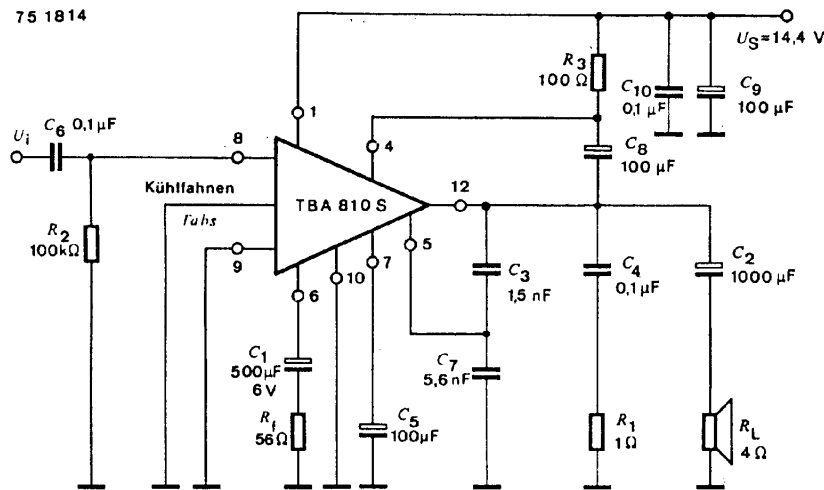
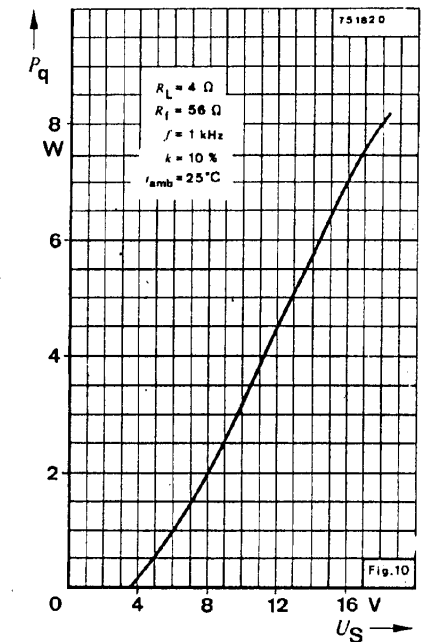
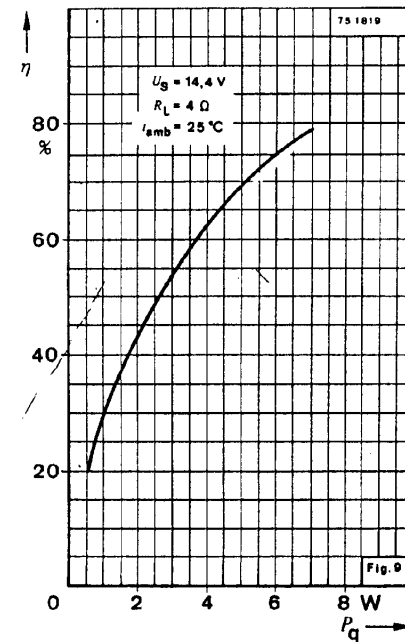
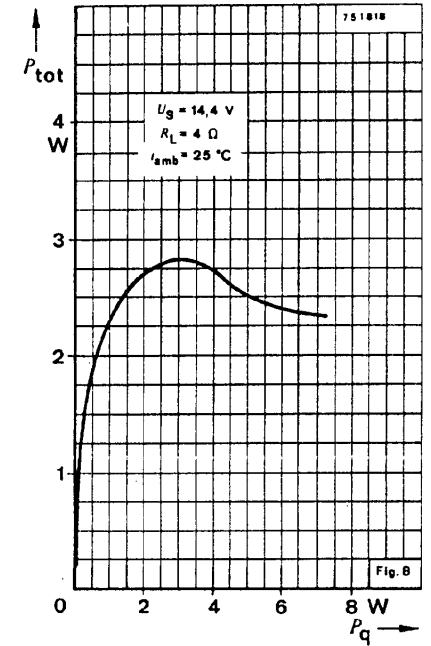
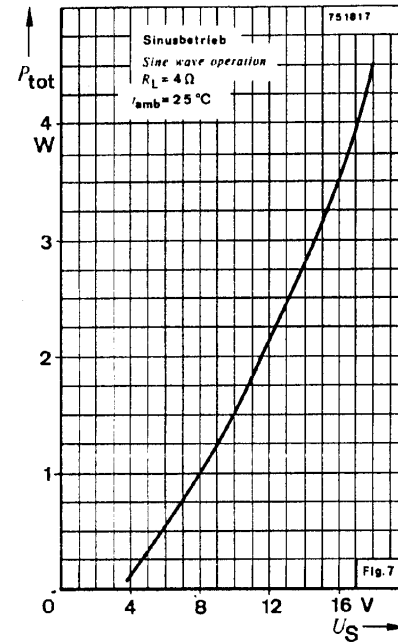
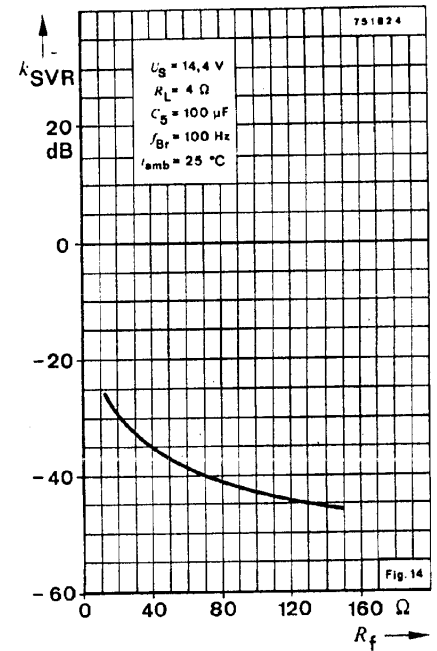
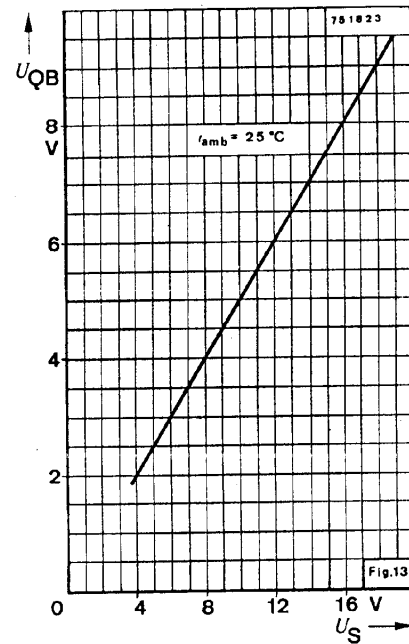
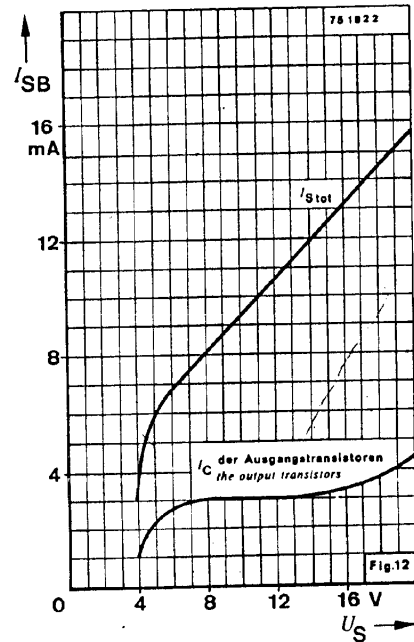
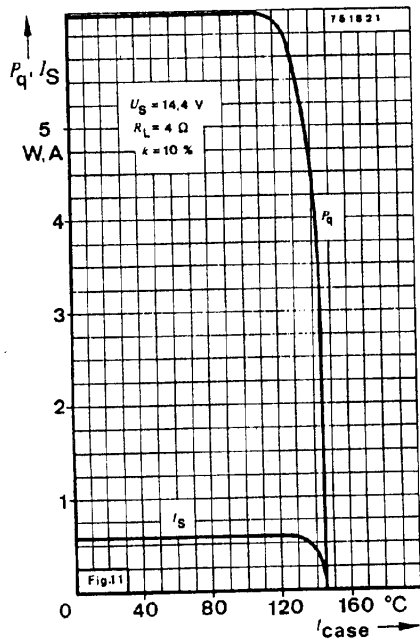

Fig. 6 Meßschaltung für: P_q, P_{tot}, k, η und Anwendungsbeispiel
Test circuit for: and application note

TBA 810 S · TBA 810 AS





Thermisches Abschalten:

Die eingebaute thermische Begrenzerschaltung ergibt folgende Vorteile:

1. Eine dauernde Überlastung des Ausgangs oder eine Erhöhung der zulässigen oberen Umgebungstemperatur kann einfach verhindert werden.
2. Die Kühlung kann gegenüber konventionellen Schaltungen mit einem kleineren Sicherheitsfaktor ausgelegt werden. Bei einer thermischen Überlastung wird der Schaltkreis nicht infolge einer zu hohen Sperrschichttemperatur zerstört, denn es wird ausschließlich P_Q (und somit P_{tot}) und I_S reduziert (siehe Fig. 11).

Thermal shut-down

The presence of a thermal limiting circuit offers the following advantages:

1. An overload on the output (even if it is permanent), or an above-limit ambient temperature can be easily supported.
2. The heat sink can have a smaller factor of safety compared with that of a conventional circuit. There is no device damage in the case of too high a junction temperature: all that happens is that P_Q (and therefor P_{tot}) and I_S are reduced (fig. 11).

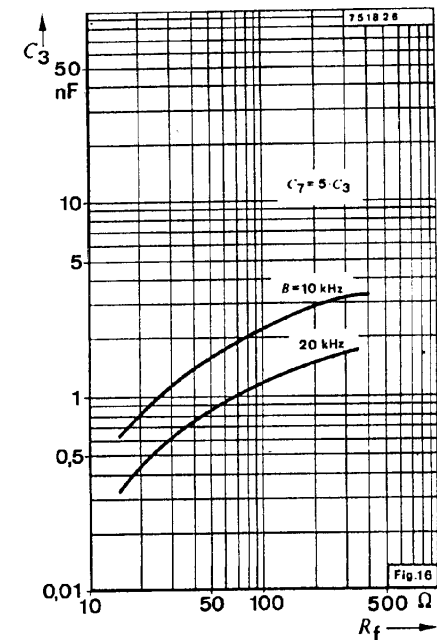
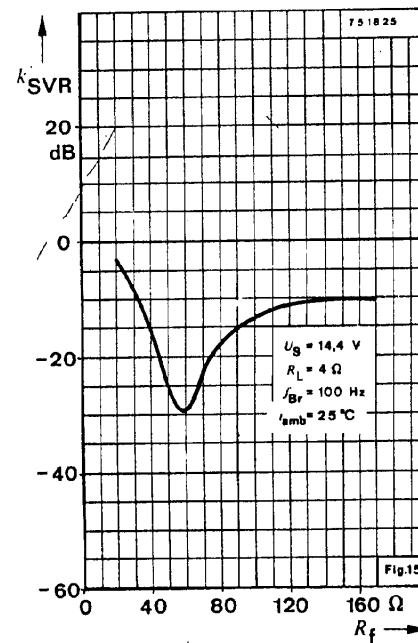

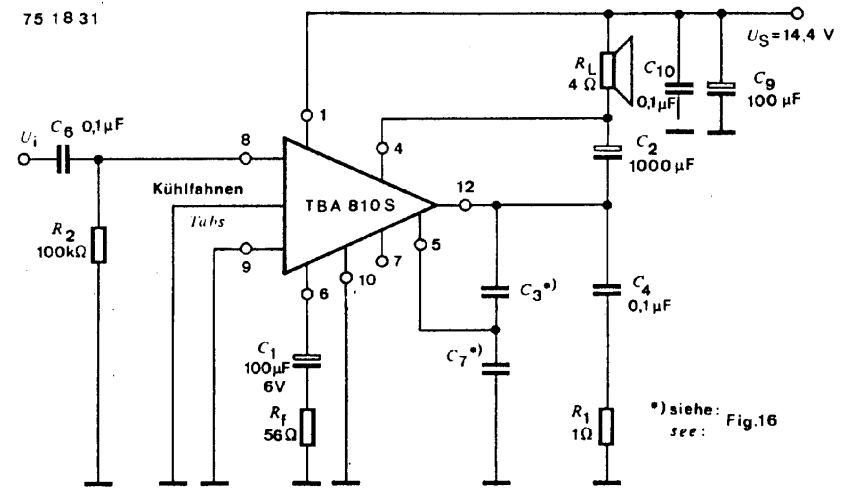
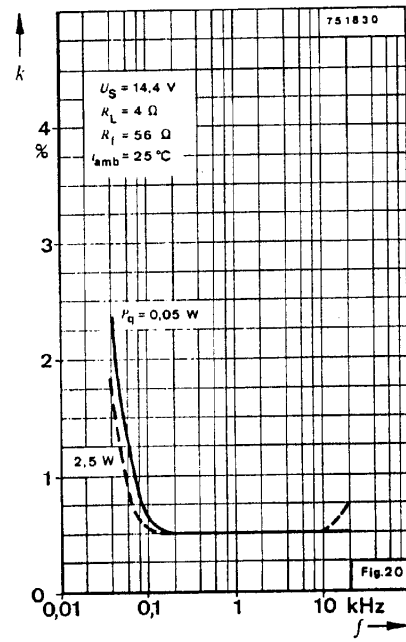
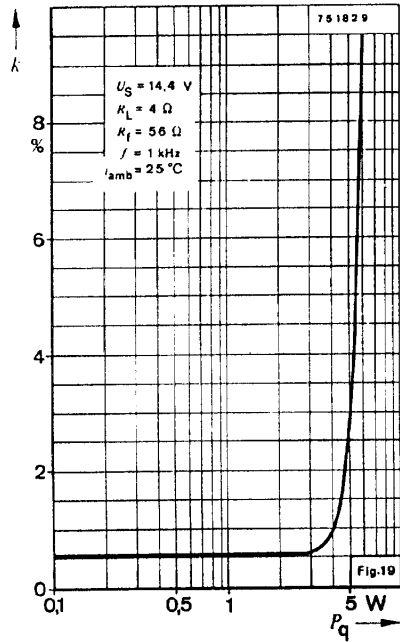
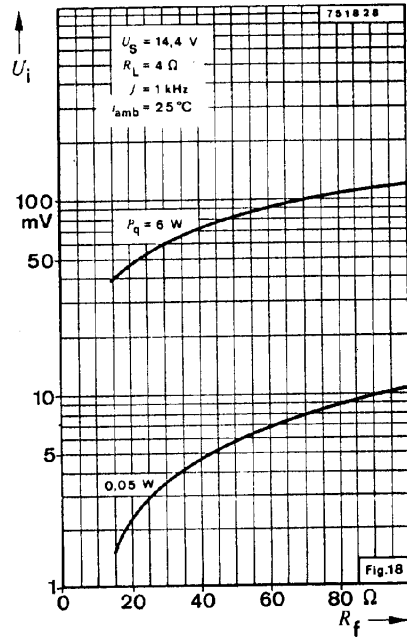
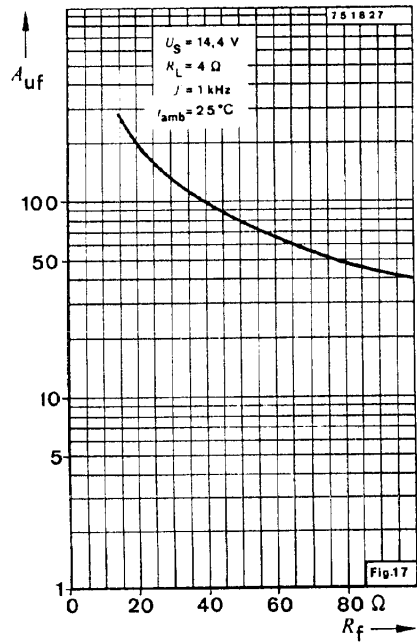

Fig. 21 Schaltungsbeispiel mit hochliegendem R_L
Circuit example with load connected to supply voltage