

TPIC1504 QUAD AND HEX POWER DMOS ARRAY

SLIS057 – OCTOBER 1996

- Low $r_{DS(on)}$:
0.25 Ω Typ (Full H-Bridge)
0.15 Ω Typ (Triple Half H-Bridge)
- Pulsed Current:
6 A Per Channel (Full H-Bridge)
8 A Per Channel (Triple Half H-Bridge)
- Matched Sense Transistor for Class A-B
Linear Operation
- Fast Commutation Speed

description

The TPIC1504 is a monolithic power DMOS array that consists of ten electrically isolated N-channel enhancement-mode power DMOS transistors, four of which are configured as a full H-bridge and six as a triple half H-bridge. The lower stage of the full H-bridge is provided with an integrated sense-FET to allow biasing of the bridge in class A-B operation.

The TPIC1504 is offered in a 24-pin wide-body surface-mount (DW) package and is characterized for operation over the case temperature range of -40°C to 125°C .

DW PACKAGE
(TOP VIEW)

OUTPUT1	1	24	GATE3A
GATE2C	2	23	GATE1A
GATE1B	3	22	GATE4A
GATE3B	4	21	V _{DD1}
GND	5	20	V _{DD3}
OUTPUT3	6	19	OUTPUT4
SOURCE	7	18	V _{DD3}
OUTPUT5	8	17	GATE5A
GND	9	16	V _{DD2}
GATE4B	10	15	GATE2A
GATE2B	11	14	SENSE
GATE5B	12	13	OUTPUT2

schematic

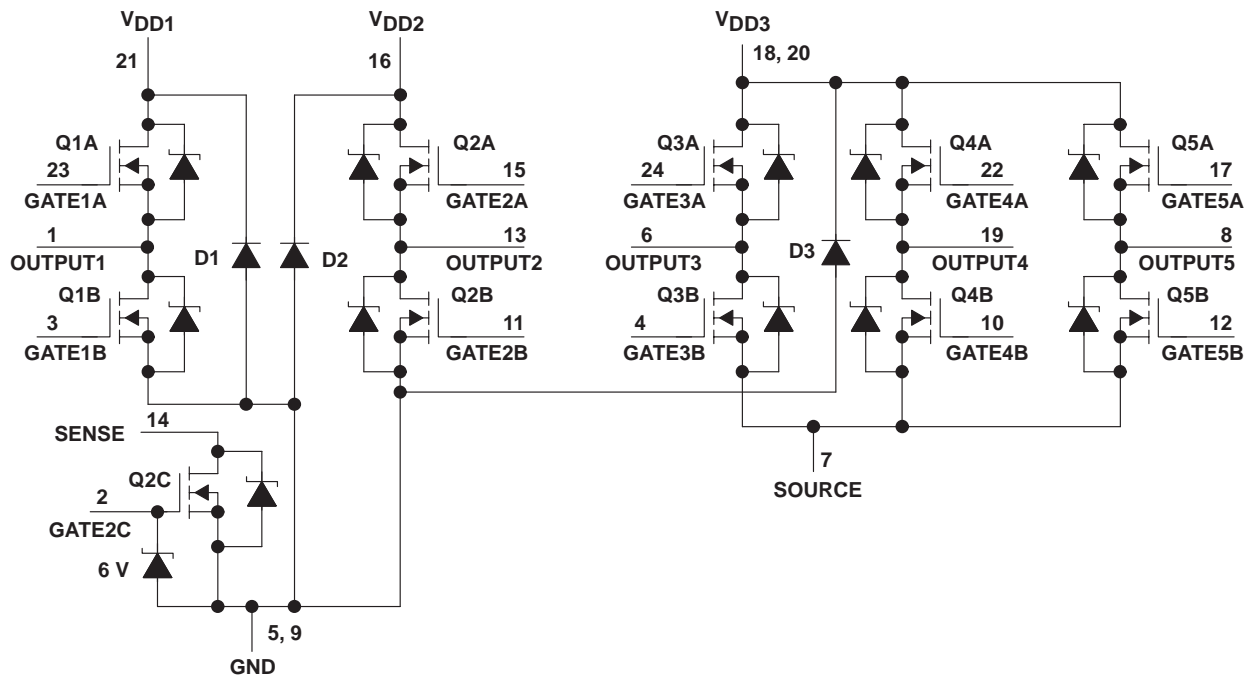

- NOTES:
- Terminals 5 and 9 must be externally connected.
 - Terminals 18 and 20 must be externally connected.
 - No output may be taken greater than 0.5 V below GND.



Please be aware that an important notice concerning availability, standard warranty, and use in critical applications of Texas Instruments semiconductor products and disclaimers thereto appears at the end of this data sheet.

PRODUCTION DATA information is current as of publication date. Products conform to specifications per the terms of Texas Instruments standard warranty. Production processing does not necessarily include testing of all parameters.

**TEXAS
INSTRUMENTS**

POST OFFICE BOX 655303 • DALLAS, TEXAS 75265

Copyright © 1996, Texas Instruments Incorporated

TPIC1504

QUAD AND HEX POWER DMOS ARRAY

SLIS057 – OCTOBER 1996

absolute maximum ratings, $T_C = 25^\circ\text{C}$ (unless otherwise noted)†

Supply-to-GND voltage	20 V
Source-to-GND voltage (Q3A, Q4A, Q5A)	20 V
Output-to-GND voltage	20 V
Sense-to-GND voltage	20 V
Gate-to-source voltage range, V_{GS} (Q1A, Q1B, Q2A, Q2B, Q3A, Q3B, Q4A, Q4B, Q5A, Q5B)	± 20 V
Gate-to-source voltage, V_{GS} (Q2C)	-0.7 V to 6 V
Continuous gate-to-source zener-diode current (Q2C)	± 10 mA
Pulsed gate-to-source zener-diode current (Q2C)	± 50 mA
Continuous drain current, each output (Q1A, Q1B, Q2A, Q2B)	1.5 A
Continuous drain current, each output (Q3A, Q3B, Q4A, Q4B, Q5A, Q5B)	2 A
Continuous drain current (Q2C)	5 mA
Continuous source-to-drain diode current (Q1A, Q1B, Q2A, Q2B)	1.5 A
Continuous source-to-drain diode current (Q3A, Q3B, Q4A, Q4B, Q5A, Q5B)	2 A
Continuous source-to-drain diode current (Q2C)	5 mA
Pulsed drain current, each output, I_{max} (Q1A, Q1B, Q2A, Q2B) (see Note 1 and Figure 24)	6 A
Pulsed drain current, each output, I_{max} (Q3A, Q3B, Q4A, Q4B, Q5A, Q5B) (see Note 1 and Figure 25)	8 A
Pulsed drain current, each output, I_{max} (Q2C) (see Note 1)	20 mA
Continuous total power dissipation, $T_C = 70^\circ\text{C}$ (see Note 2 and Figures 24 and 25)	2.86 W
Operating virtual junction temperature range, T_J	-40°C to 150°C
Operating case temperature range, T_C	-40°C to 125°C
Storage temperature range, T_{stg}	-65°C to 150°C
Lead temperature 1,6 mm (1/16 inch) from case for 10 seconds	260°C

† Stresses beyond those listed under “absolute maximum ratings” may cause permanent damage to the device. These are stress ratings only, and functional operation of the device at these or any other conditions beyond those indicated under “recommended operating conditions” is not implied. Exposure to absolute-maximum-rated conditions for extended periods may affect device reliability.

- NOTES:
1. Pulse duration = 10 ms, duty cycle = 2%
 2. Package mounted in intimate contact with infinite heatsink.



POST OFFICE BOX 655303 • DALLAS, TEXAS 75265

TPIC1504 QUAD AND HEX POWER DMOS ARRAY

SLIS057 – OCTOBER 1996

electrical characteristics, Q1A, Q1B, Q2A, Q2B, $T_C = 25^\circ\text{C}$ (unless otherwise noted)

PARAMETER		TEST CONDITIONS	MIN	TYP	MAX	UNIT
$V_{(BR)DSX}$	Drain-to-source breakdown voltage	$I_D = 250\ \mu\text{A}$, $V_{GS} = 0$	20			V
$V_{GS(th)}$	Gate-to-source threshold voltage	$I_D = 1\ \text{mA}$, See Figure 5	1.5	1.9	2.2	V
$V_{GS(th)match}$	Gate-to-source threshold voltage matching	$I_D = 1\ \text{mA}$, $V_{DS} = V_{GS}$			40	mV
$V_{(BR)}$	Reverse drain-to-GND breakdown voltage	Drain-to-GND current = $250\ \mu\text{A}$ (D1, D2)	20			V
$V_{(BR)GS}$	Gate-to-source threshold breakdown voltage, Q2C	$I_{GS} = 100\ \mu\text{A}$	6			V
$V_{(BR)SG}$	Source-to-gate breakdown voltage, Q2C	$I_{SG} = 100\ \mu\text{A}$	0.5			V
$V_{(DS)on}$	Drain-to-source on-state voltage	$I_D = 1.5\ \text{A}$, $V_{GS} = 10\ \text{V}$, See Notes 3 and 4		0.375	0.45	V
V_F	Forward on-state voltage, GND-to- V_{DD1} , GND-to- V_{DD2}	$I_D = 1.5\ \text{A}$ (D1, D2) See Notes 3 and 4		1.7		V
$V_F(SD)$	Forward on-state voltage, source-to-drain	$I_S = 1.5\ \text{A}$, $V_{GS} = 0$, See Notes 3 and 4 and Figure 19		0.85	1.2	V
I_{DSS}	Zero-gate-voltage drain current	$V_{DS} = 16\ \text{V}$, $V_{GS} = 0$	$T_C = 25^\circ\text{C}$	0.05	1	μA
			$T_C = 125^\circ\text{C}$	0.5	10	
I_{GSSF}	Forward gate current, drain short-circuited to source	$V_{GS} = 16\ \text{V}$, $V_{DS} = 0$		10	100	nA
I_{GSSR}	Reverse gate current, drain short-circuited to source	$V_{SG} = 0.5\ \text{V}$, $V_{DS} = 0$		10	100	nA
I_{lkg}	Leakage current, V_{DD1} -to-GND, V_{DD2} -to-GND, gate shorted to source	$V_{DGND} = 16\ \text{V}$	$T_C = 25^\circ\text{C}$	0.05	1	μA
			$T_C = 125^\circ\text{C}$	0.5	10	
$r_{DS(on)}$	Static drain-to-source on-state resistance	$V_{GS} = 10\ \text{V}$, $I_D = 1.5\ \text{A}$, See Notes 3 and 4 and Figure 9	$T_C = 25^\circ\text{C}$	0.25	0.3	Ω
			$T_C = 125^\circ\text{C}$	0.4	0.475	
g_{fs}	Forward transconductance	$V_{DS} = 14\ \text{V}$, $I_D = 750\ \text{mA}$, See Notes 3 and 4 and Figure 13	0.8	1.2		S
C_{iss}	Short-circuit input capacitance, common source	$V_{DS} = 14\ \text{V}$, $f = 1\ \text{MHz}$, $V_{GS} = 0$, See Figure 17		99		pF
C_{oss}	Short-circuit output capacitance, common source			81		
C_{rss}	Short-circuit reverse transfer capacitance, common source			59		
α_s	Sense-FET drain current ratio	$V_{DS} = 6\ \text{V}$, $I_{D(Q2C)} = 40\ \mu\text{A}$	100	150	200	

NOTES: 3. Technique should limit $T_J - T_C$ to 10°C maximum.

4. These parameters are measured with voltage-sensing contacts separate from the current-carrying contacts.

source-to-drain diode characteristics, Q1A, Q2A, $T_C = 25^\circ\text{C}$

PARAMETER		TEST CONDITIONS	MIN	TYP	MAX	UNIT
t_{rr}	Reverse-recovery time	$I_S = 750\ \text{mA}$, $V_{GS} = 0$, $V_{DS} = 14\ \text{V}$, See Figures 1 and 23 $di/dt = 100\ \text{A}/\mu\text{s}$,		18		ns
Q_{RR}	Total diode charge			13		nC



TPIC1504

QUAD AND HEX POWER DMOS ARRAY

SLIS057 – OCTOBER 1996

resistive-load switching characteristics, Q1A, Q1B, Q2A, Q2B, T_C = 25°C

PARAMETER	TEST CONDITIONS	MIN	TYP	MAX	UNIT
t _{d(on)} Turn-on delay time	V _{DD} = 14 V, R _L = 18.7 Ω, t _{en} = 10 ns, t _{dis} = 10 ns, See Figure 3		11		ns
t _{d(off)} Turn-off delay time			16		
t _r Rise time			3		
t _f Fall time			4		
Q _g Total gate charge	V _{DS} = 14 V, I _D = 750 mA, V _{GS} = 10 V, See Figure 4 and Figure 21		1.8	2.5	nC
Q _{gs(th)} Threshold gate-to-source charge			0.3	0.4	
Q _{gd} Gate-to-drain charge			0.5	0.6	
L _D Internal drain inductance			7		nH
L _S Internal source inductance			7		
R _g Internal gate resistance			10		

electrical characteristics, Q3A, Q3B, Q4A, Q4B, Q5A, Q5B, T_C = 25°C (unless otherwise noted)

PARAMETER	TEST CONDITIONS	MIN	TYP	MAX	UNIT
V _{(BR)DSX} Drain-to-source breakdown voltage	I _D = 250 μA, V _{GS} = 0	20			V
V _{GS(th)} Gate-to-source threshold voltage	I _D = 1 mA, V _{DS} = V _{GS} , See Figure 6	1.5	1.9	2.2	V
V _(BR) Reverse drain-to-GND breakdown voltage	Drain-to-GND current = 250 μA (D3)	20			V
V _{(DS)on} Drain-to-source on-state voltage	I _D = 2 A, V _{GS} = 10 V, See Notes 3 and 4		0.3	0.35	V
V _F Forward on-state voltage, GND-to-V _{DD3}	I _D = 2 A (D3), See Notes 3 and 4		1.5		V
V _{F(SD)} Forward on-state voltage, source-to-drain	I _S = 2 A, V _{GS} = 0, See Notes 3 and 4 and Figure 20		0.85	1.2	V
I _{DSS} Zero-gate-voltage drain current	V _{DS} = 16 V, V _{GS} = 0		0.05	1	μA
	T _C = 25°C				
	T _C = 125°C		0.5	10	
I _{GSSF} Forward gate current, drain short-circuited to source	V _{GS} = 16 V, V _{DS} = 0		10	100	nA
I _{GSSR} Reverse gate current, drain short-circuited to source	V _{SG} = 16 V, V _{DS} = 0		10	100	nA
I _{lkg} Leakage current, V _{DD3} -to-GND, gate shorted to source	V _{DGND} = 16 V		0.05	1	μA
	T _C = 25°C				
	T _C = 125°C		0.5	10	
r _{DS(on)} Static drain-to-source on-state resistance	V _{GS} = 10 V, I _D = 2 A, See Notes 3 and 4 and Figure 10		0.15	0.175	Ω
	T _C = 125°C		0.24	0.275	
g _{fs} Forward transconductance	V _{DS} = 14 V, I _D = 1 A, See Notes 3 and 4 and Figure 14	1	1.7		S
C _{iSS} Short-circuit input capacitance, common source	V _{DS} = 14 V, f = 1 MHz, V _{GS} = 0, See Figure 18		160		pF
C _{oSS} Short-circuit output capacitance, common source			220		
C _{rSS} Short-circuit reverse transfer capacitance, common source			110		

NOTES: 3: Technique should limit T_J – T_C to 10°C maximum.

4: These parameters are measured with voltage-sensing contacts separate from the current-carrying contacts.



POST OFFICE BOX 655303 • DALLAS, TEXAS 75265

TPIC1504 QUAD AND HEX POWER DMOS ARRAY

SLIS057 – OCTOBER 1996

source-to-drain diode characteristics, Q3A, Q4A, Q5A, T_C = 25°C

PARAMETER		TEST CONDITIONS	MIN	TYP	MAX	UNIT
t _{rr}	Reverse-recovery time	I _S = 1 A, V _{GS} = 0, V _{DS} = 14 V, di/dt = 100 A/μs, See Figures 2 and 23		34		ns
Q _{RR}	Total diode charge			30		nC

resistive-load switching characteristics, Q3A, Q3B, Q4A, Q4B, Q5A, Q5B, T_C = 25°C

PARAMETER		TEST CONDITIONS	MIN	TYP	MAX	UNIT
t _{d(on)}	Turn-on delay time	V _{DD} = 14 V, R _L = 14 Ω, t _{en} = 10 ns, t _{dis} = 10 ns, See Figure 3		30		ns
t _{d(off)}	Turn-off delay time			34		
t _r	Rise time			15		
t _f	Fall time			21		
Q _g	Total gate charge	V _{DS} = 14 V, I _D = 1 A, V _{GS} = 10 V, See Figure 4 and Figure 22		3.2	4.5	nC
Q _{gs(th)}	Threshold gate-to-source charge			0.5	0.6	
Q _{gd}	Gate-to-drain charge			0.9	1.1	
L _D	Internal drain inductance			7		nH
L _S	Internal source inductance			7		
R _g	Internal gate resistance			10		

thermal resistance

PARAMETER		TEST CONDITIONS	MIN	TYP	MAX	UNIT
R _{θJA}	Junction-to-ambient thermal resistance	See Notes 5 and 8		90		°C/W
R _{θJB}	Junction-to-board thermal resistance	See Notes 6 and 8		52		
R _{θJP}	Junction-to-pin thermal resistance	See Notes 7 and 8		28		

- NOTES: 5. Package mounted on a FR4 printed-circuit board with no heatsink.
6. Package mounted on a 24 in², 4-layer FR4 printed-circuit board.
7. Package mounted in intimate contact with infinite heatsink.
8. All outputs with equal power



TPIC1504 QUAD AND HEX POWER DMOS ARRAY

SLIS057 – OCTOBER 1996

PARAMETER MEASUREMENT INFORMATION

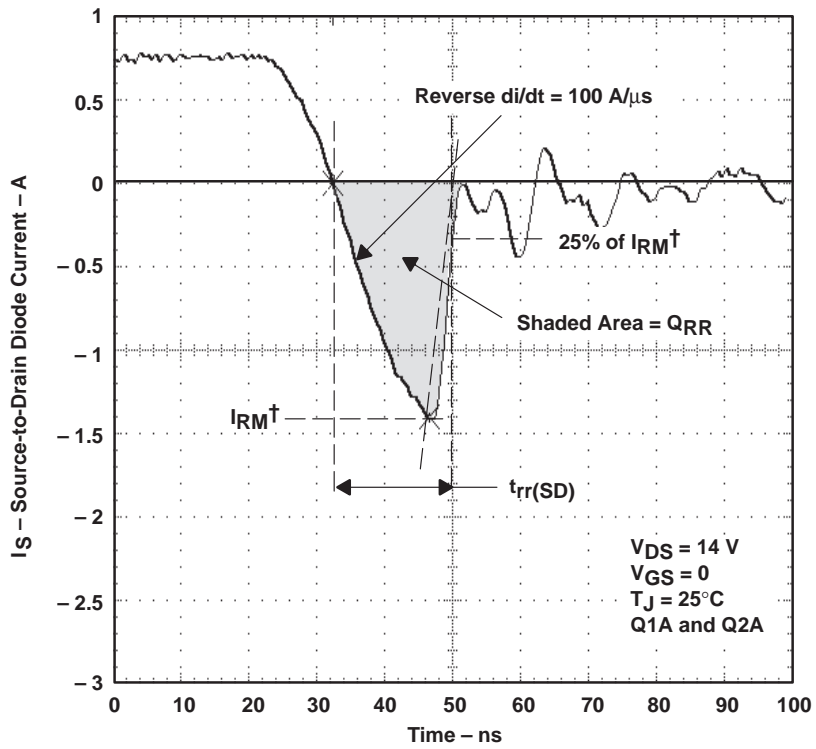

$^\dagger I_{RM}$ = maximum recovery current

Figure 1. Reverse-Recovery-Current Waveform of Source-to-Drain Diodes

PARAMETER MEASUREMENT INFORMATION

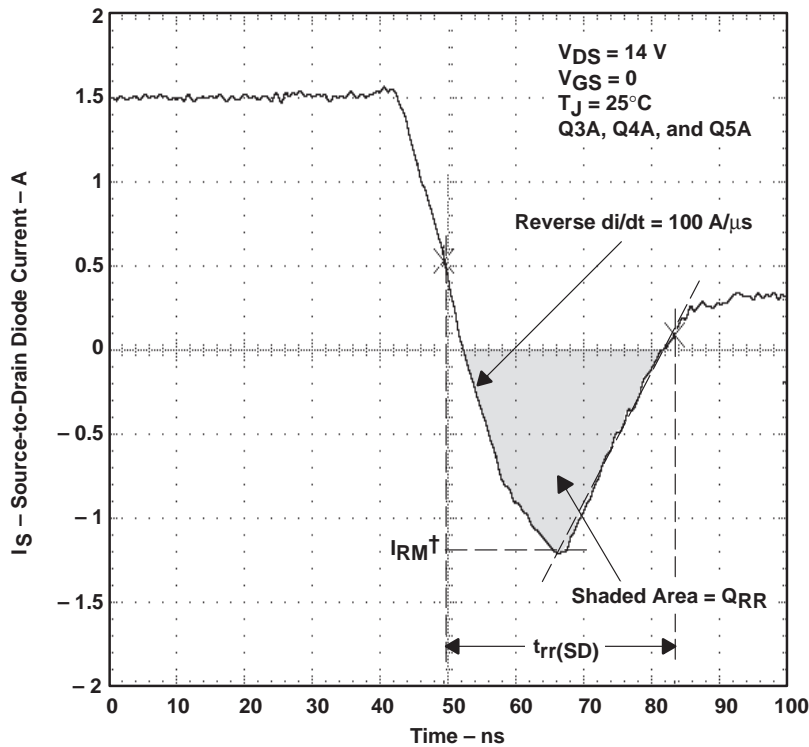

$^\dagger I_{RM}$ = maximum recovery current

Figure 2. Reverse-Recovery-Current Waveform of Source-to-Drain Diodes

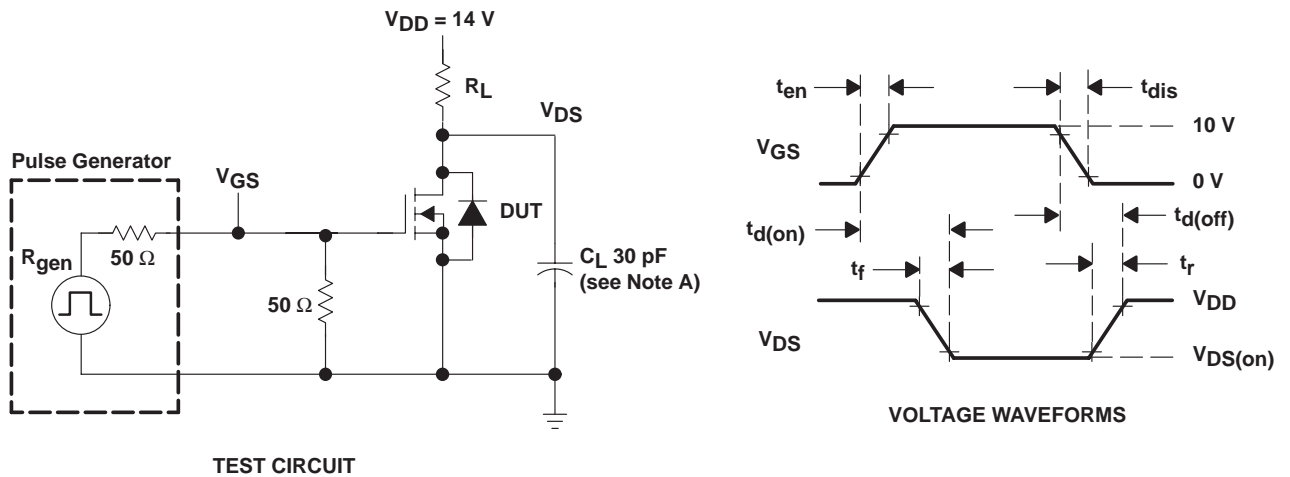

TEST CIRCUIT

NOTE A: C_L includes probe and jig capacitance.

Figure 3. Resistive-Switching Test Circuit and Voltage Waveforms

TPIC1504 QUAD AND HEX POWER DMOS ARRAY

SLIS057 – OCTOBER 1996

PARAMETER MEASUREMENT INFORMATION

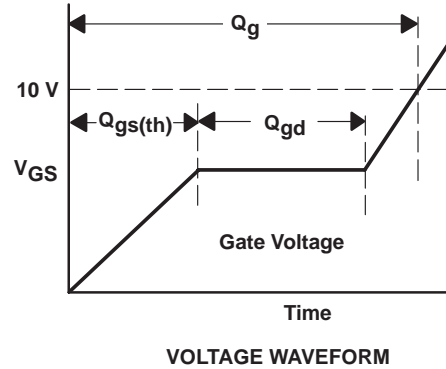
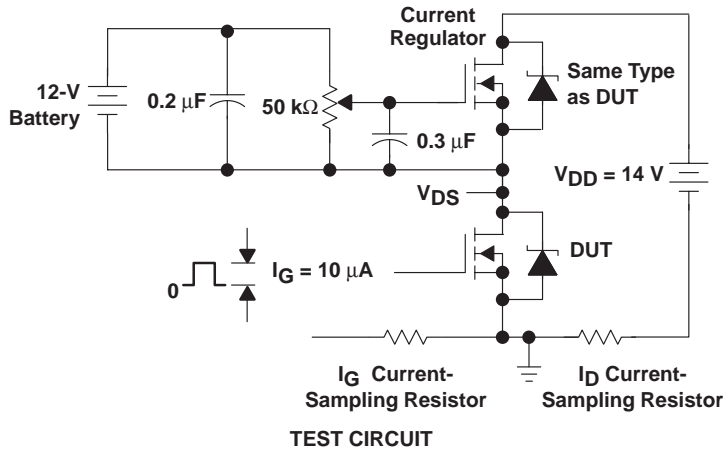
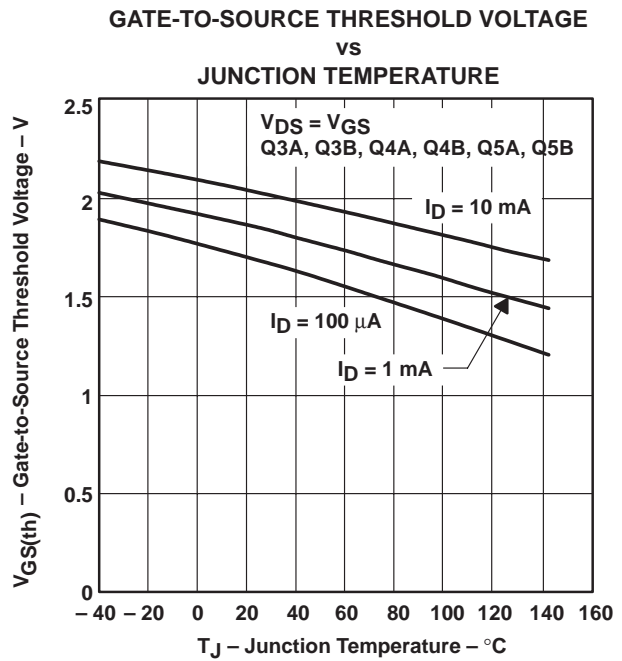
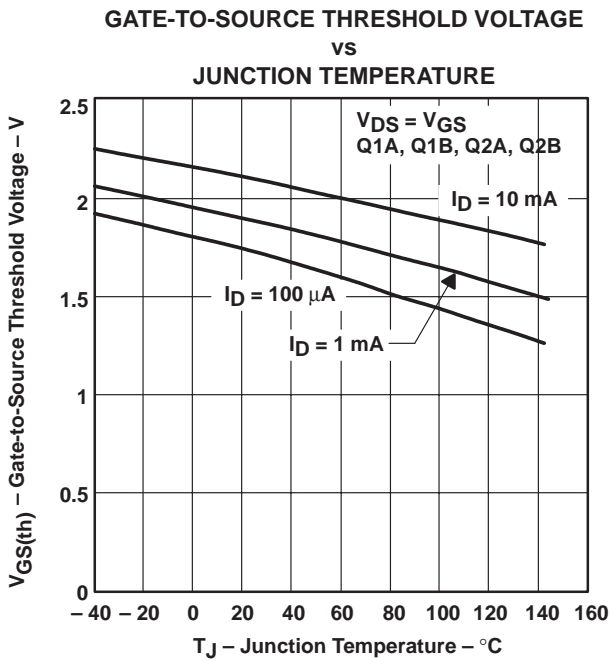

Figure 4. Gate-Charge Test Circuit and Voltage Waveform

TYPICAL CHARACTERISTICS



TYPICAL CHARACTERISTICS

STATIC DRAIN-TO-SOURCE ON-STATE RESISTANCE
 vs
 JUNCTION TEMPERATURE

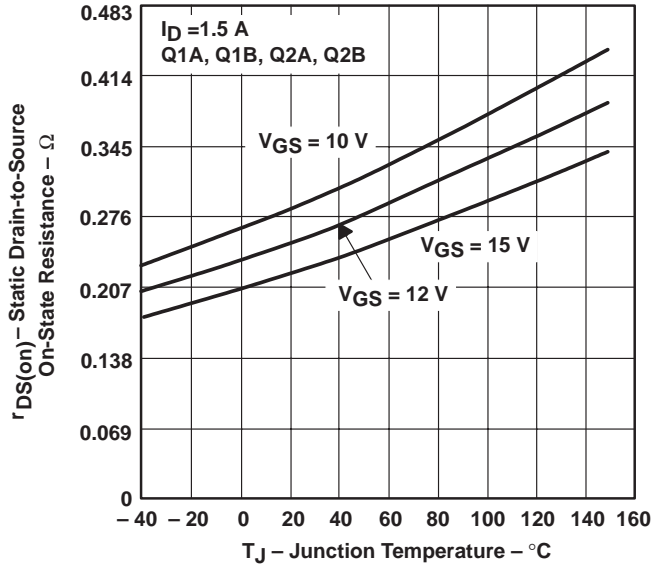

Figure 7

STATIC DRAIN-TO-SOURCE ON-STATE RESISTANCE
 vs
 JUNCTION TEMPERATURE

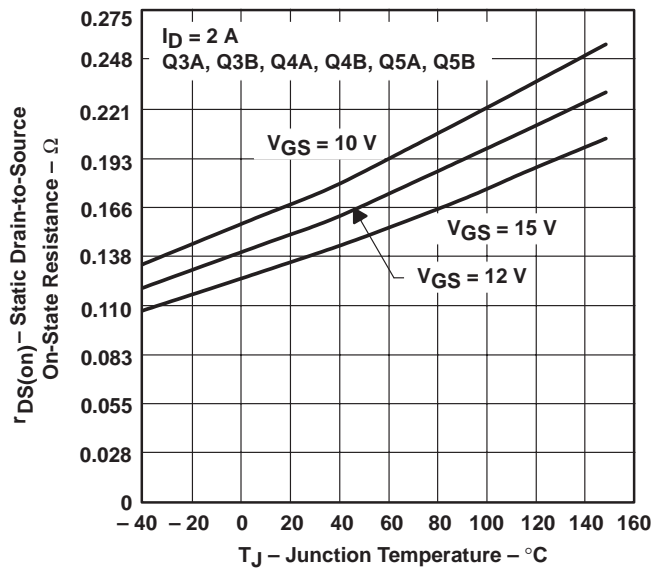

Figure 8

TPIC1504 QUAD AND HEX POWER DMOS ARRAY

SLIS057 – OCTOBER 1996

TYPICAL CHARACTERISTICS

STATIC DRAIN-TO-SOURCE ON-STATE RESISTANCE

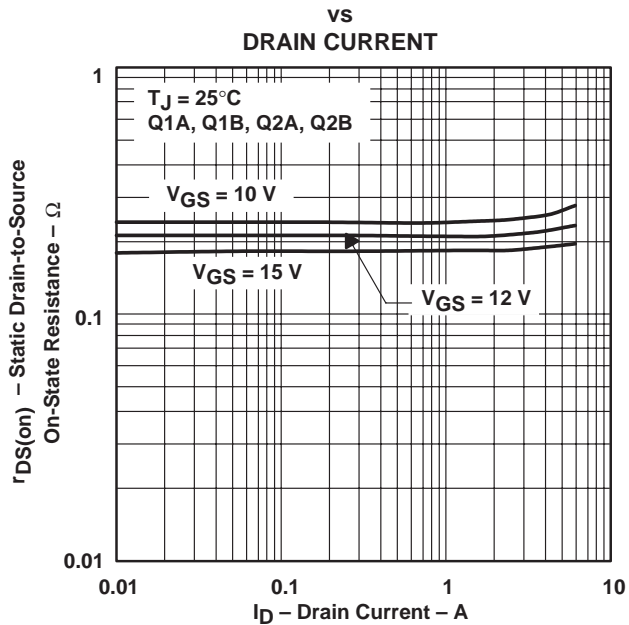

Figure 9

STATIC DRAIN-TO-SOURCE ON-STATE RESISTANCE

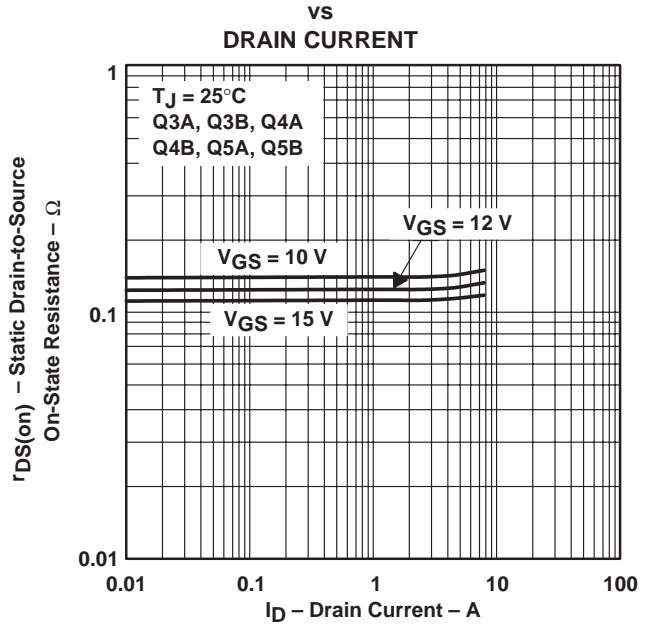

Figure 10

DRAIN CURRENT
vs
DRAIN-TO-SOURCE VOLTAGE

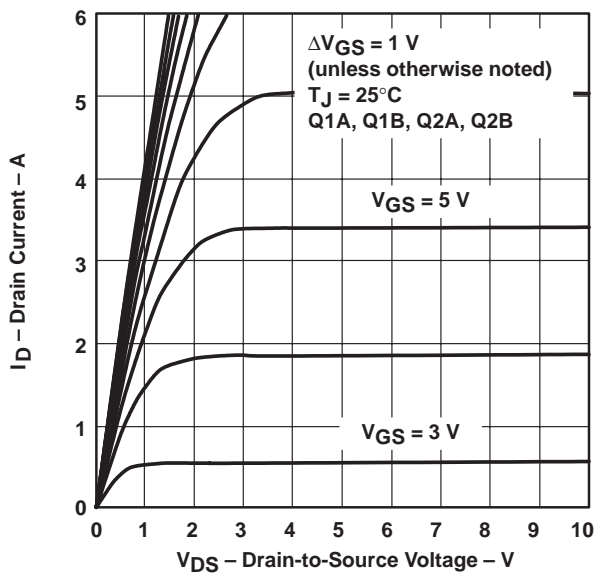

Figure 11

DRAIN CURRENT
vs
DRAIN-TO-SOURCE VOLTAGE

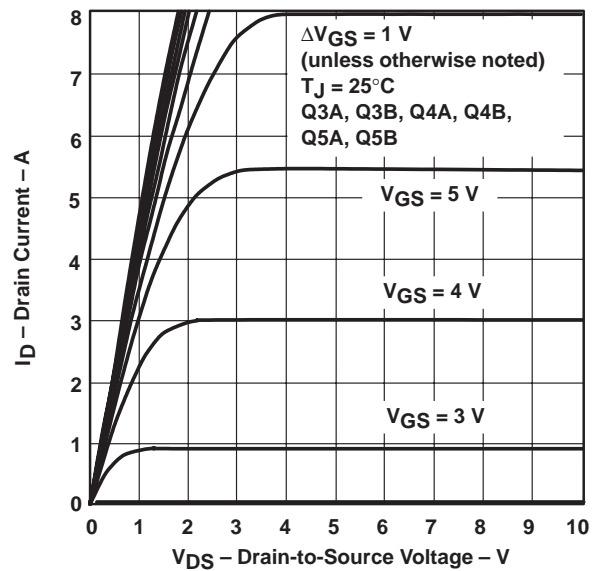

Figure 12

TYPICAL CHARACTERISTICS

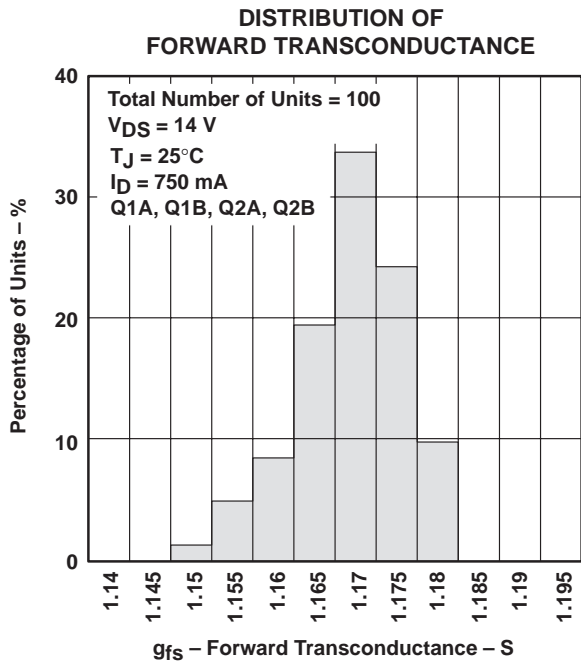

Figure 13

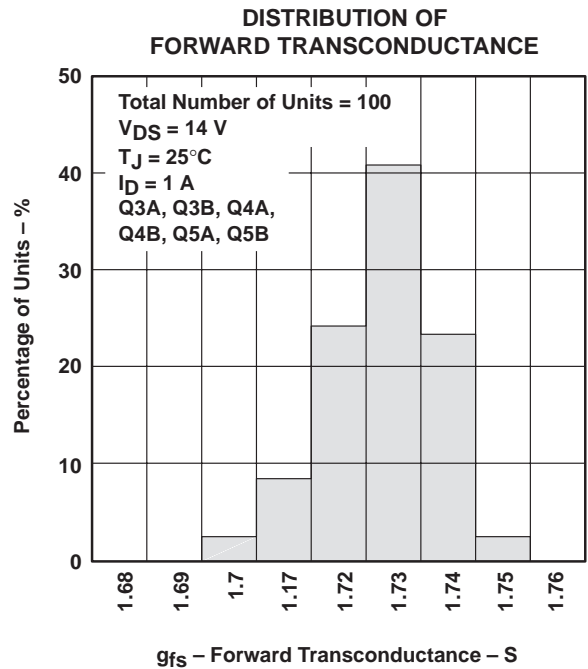

Figure 14

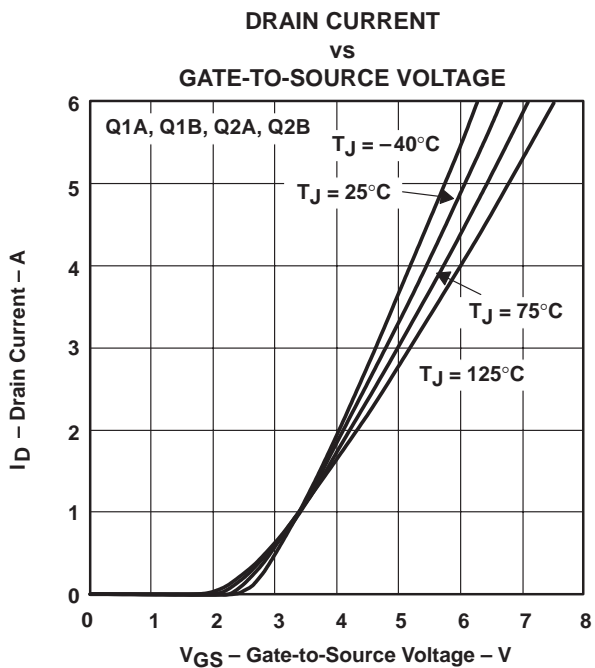

Figure 15

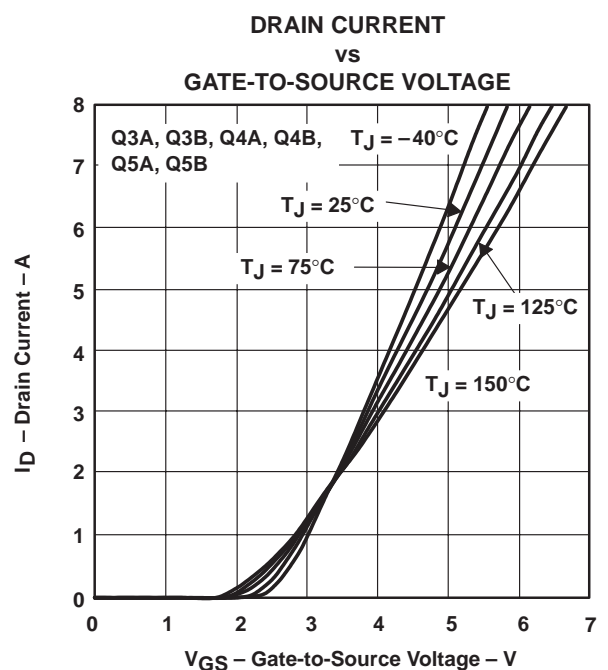

Figure 16

TPIC1504 QUAD AND HEX POWER DMOS ARRAY

SLIS057 – OCTOBER 1996

TYPICAL CHARACTERISTICS

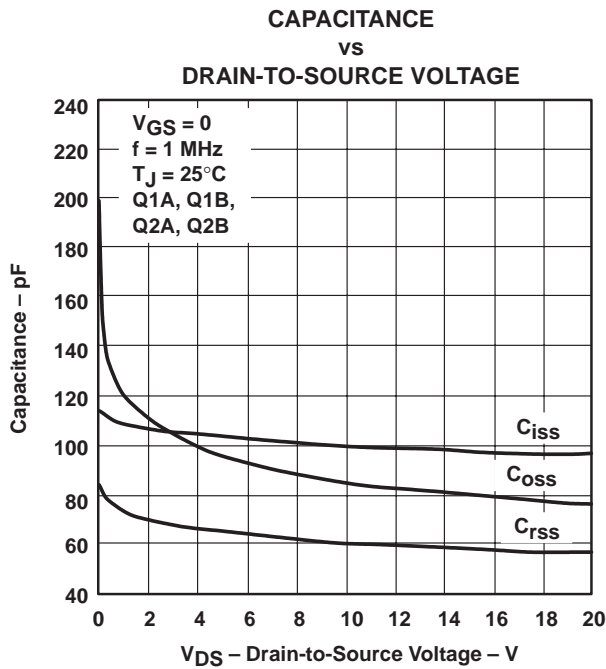

Figure 17

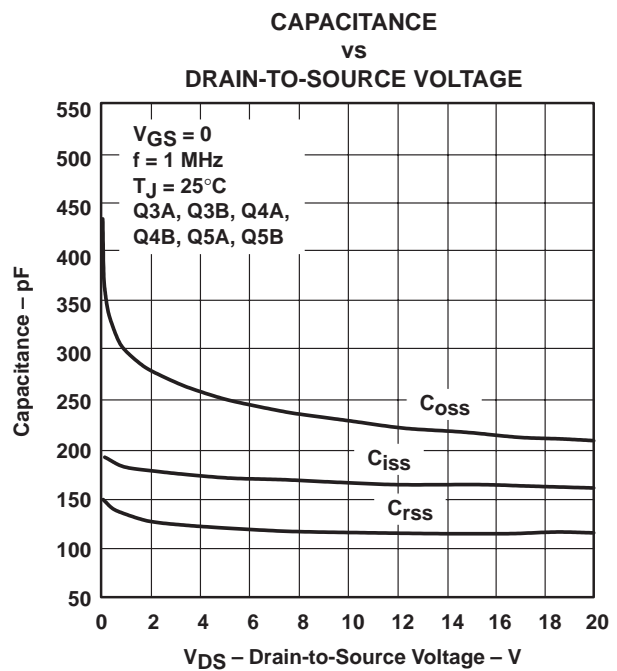

Figure 18

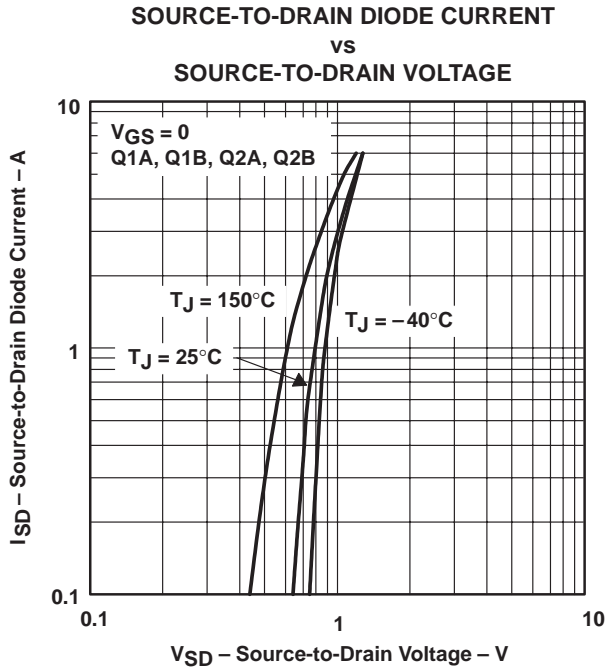

Figure 19

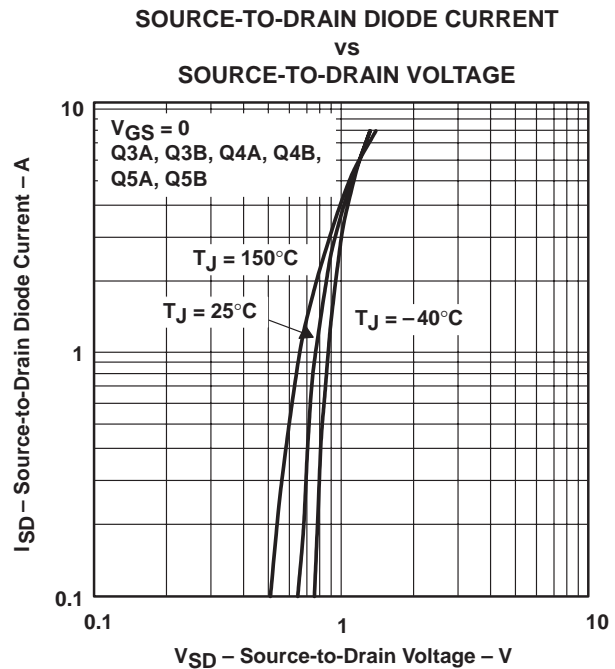
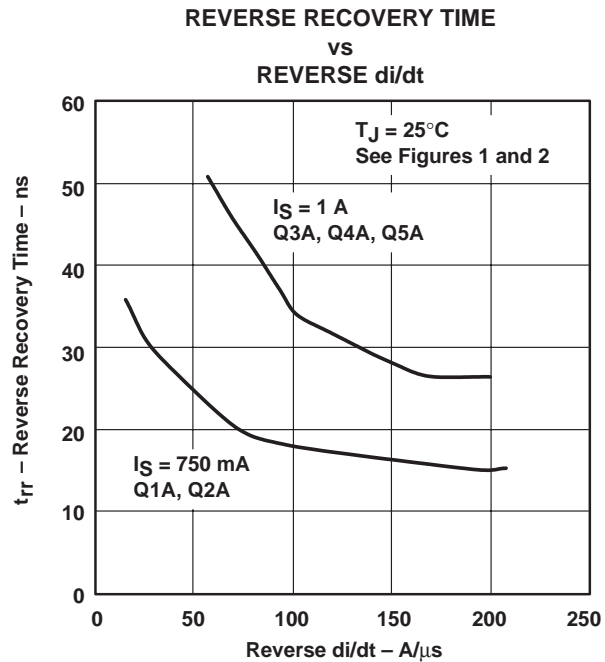
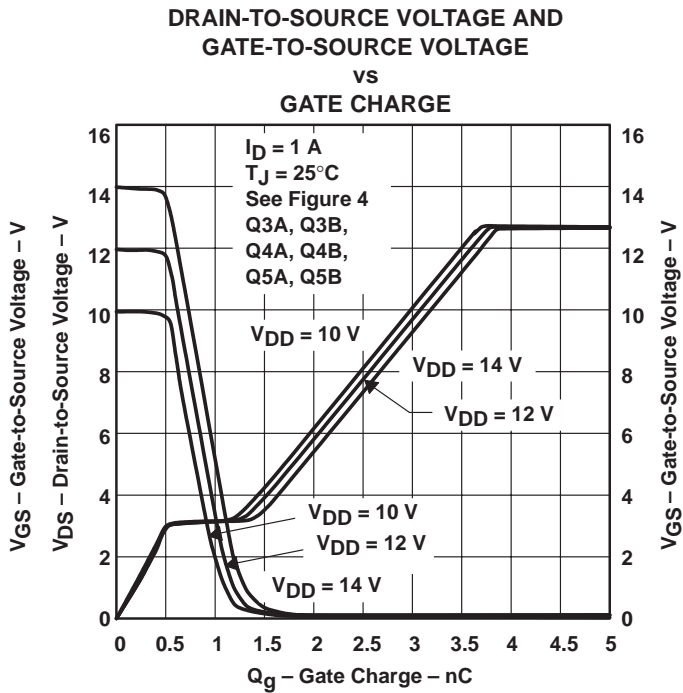
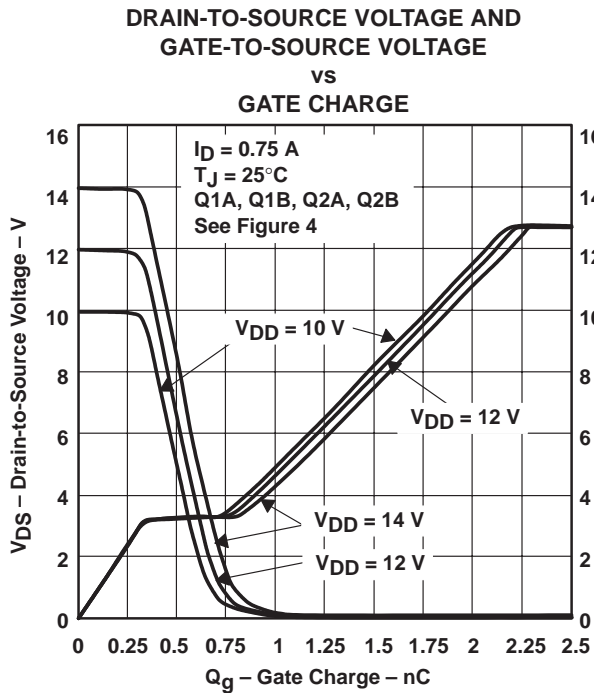

Figure 20

TYPICAL CHARACTERISTICS



TPIC1504 QUAD AND HEX POWER DMOS ARRAY

SLIS057 – OCTOBER 1996

THERMAL INFORMATION

MAXIMUM DRAIN CURRENT vs DRAIN-TO-SOURCE VOLTAGE

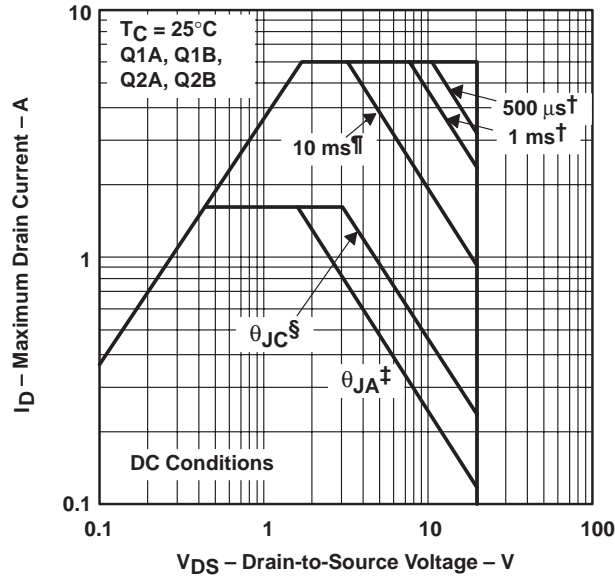

Figure 24

MAXIMUM DRAIN CURRENT vs DRAIN-TO-SOURCE VOLTAGE

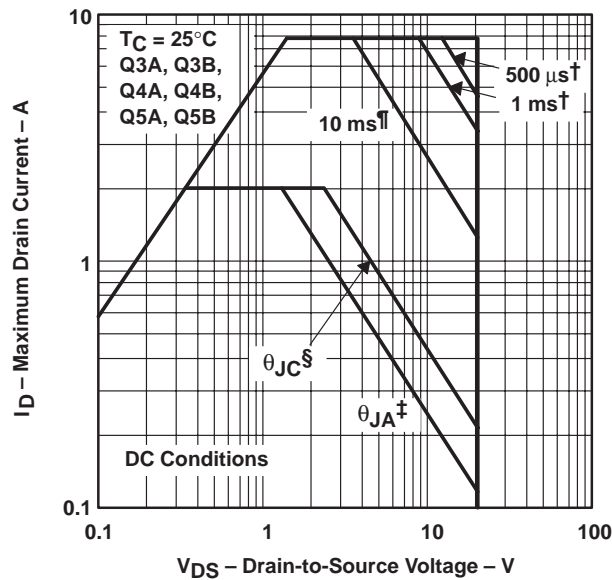

Figure 25

[†] Less than 10% duty cycle

[‡] Device mounted on a 24-in², 4-layer FR4 printed-circuit board.

[§] Device mounted in intimate contact with infinite heat sink.

[¶] Less than 2% duty cycle



POST OFFICE BOX 655303 • DALLAS, TEXAS 75265

THERMAL INFORMATION

DW PACKAGE†
 JUNCTION-TO-BOARD THERMAL RESISTANCE
 VS
 PULSE DURATION

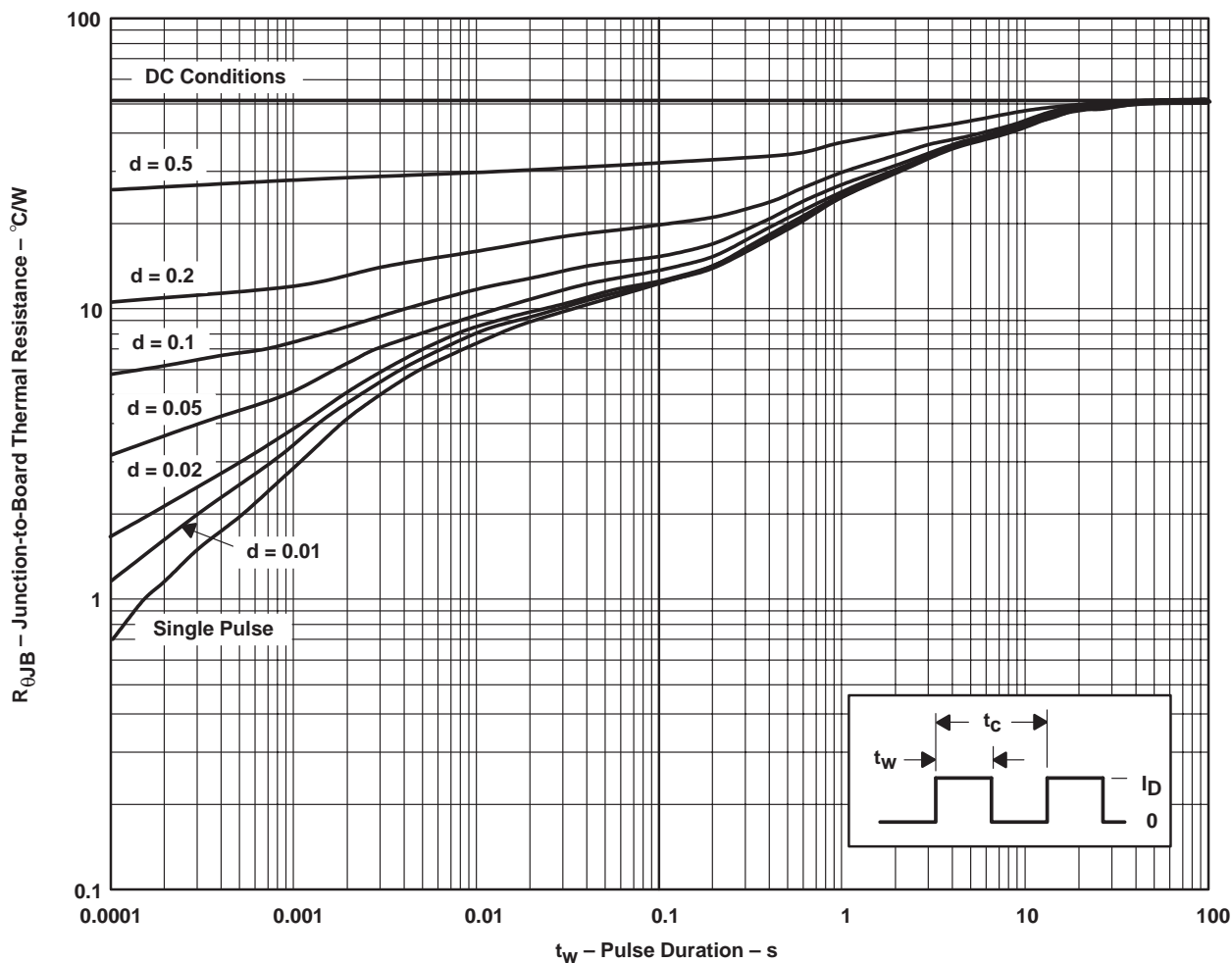

† Device is mounted on 24-in², 4-layer FR4 printed circuit board with no heat sink.

NOTE A: $Z_{\theta B}(t) = r(t) R_{\theta JB}$
 t_w = pulse duration
 t_c = cycle time
 d = duty cycle = t_w/t_c

Figure 26

IMPORTANT NOTICE

Texas Instruments and its subsidiaries (TI) reserve the right to make changes to their products or to discontinue any product or service without notice, and advise customers to obtain the latest version of relevant information to verify, before placing orders, that information being relied on is current and complete. All products are sold subject to the terms and conditions of sale supplied at the time of order acknowledgement, including those pertaining to warranty, patent infringement, and limitation of liability.

TI warrants performance of its semiconductor products to the specifications applicable at the time of sale in accordance with TI's standard warranty. Testing and other quality control techniques are utilized to the extent TI deems necessary to support this warranty. Specific testing of all parameters of each device is not necessarily performed, except those mandated by government requirements.

CERTAIN APPLICATIONS USING SEMICONDUCTOR PRODUCTS MAY INVOLVE POTENTIAL RISKS OF DEATH, PERSONAL INJURY, OR SEVERE PROPERTY OR ENVIRONMENTAL DAMAGE ("CRITICAL APPLICATIONS"). TI SEMICONDUCTOR PRODUCTS ARE NOT DESIGNED, AUTHORIZED, OR WARRANTED TO BE SUITABLE FOR USE IN LIFE-SUPPORT DEVICES OR SYSTEMS OR OTHER CRITICAL APPLICATIONS. INCLUSION OF TI PRODUCTS IN SUCH APPLICATIONS IS UNDERSTOOD TO BE FULLY AT THE CUSTOMER'S RISK.

In order to minimize risks associated with the customer's applications, adequate design and operating safeguards must be provided by the customer to minimize inherent or procedural hazards.

TI assumes no liability for applications assistance or customer product design. TI does not warrant or represent that any license, either express or implied, is granted under any patent right, copyright, mask work right, or other intellectual property right of TI covering or relating to any combination, machine, or process in which such semiconductor products or services might be or are used. TI's publication of information regarding any third party's products or services does not constitute TI's approval, warranty or endorsement thereof.