

SN75ALS193 QUADRUPLE DIFFERENTIAL LINE RECEIVER

SLLS008D – JUNE 1986 – REVISED MAY 1995

- Meets or Exceeds ANSI Standard EIA/TIA-422-B and EIA/TIA-423-A and ITU Recommendations V.10 and V.11
- Designed for Multipoint Bus Transmission on Long Bus Lines in Noisy Environments
- 3-State Outputs
- Common-Mode Input Voltage Range –7 V to 7 V
- Input Sensitivity . . . ± 200 mV
- Input Hysteresis . . . 120 mV Typ
- High Input Impedance . . . 12 k Ω Min
- Operates from Single 5-V Supply
- Low Supply Current Requirement 35 mA Max
- Improved Speed and Power Version of the AM26LS32A

SN75ALS193 . . . D, J OR N PACKAGE
(TOP VIEW)

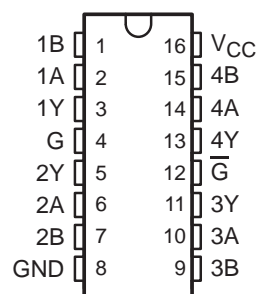

description

The SN75ALS193 is a monolithic quadruple line receiver with 3-state outputs designed using advanced low-power Schottky technology. This technology provides combined improvements in bar design, tooling production, and wafer fabrication. This, in turn, provides significantly lower power requirements and permits much higher data throughput than other designs. This device meets the specifications of ANSI Standards EIA/TIA-422-B and EIA/TIA-423-A and ITU Recommendations V.10 and V.11. It features 3-state outputs that permit direct connection to a bus-organized system with a fail-safe design that ensures the outputs will always be high if the inputs are open.

The device is optimized for balanced multipoint bus transmission at rates up to 20 megabits per second. The input features high input impedance, input hysteresis for increased noise immunity, and an input sensitivity of ± 200 mV over a common-mode input voltage range of –7 V to 7 V. It also features active-high and active-low enable functions that are common to the four channels. The SN75ALS193 is designed for optimum performance when used with the 'ALS192 quadruple differential line driver.

The SN75ALS193 is characterized for operation from 0°C to 70°C.

FUNCTION TABLE
(each receiver)

DIFFERENTIAL INPUTS A – B	ENABLES		OUTPUT Y
	G	\overline{G}	
$V_{ID} \geq 0.2$ V	H	X	H
	X	L	H
-0.2 V < V_{ID} < 0.2 V	H	X	?
	X	L	?
$V_{ID} \leq -0.2$ V	H	X	L
	X	L	L
X	L	H	Z
Open	H	X	H
	X	L	H

H = high level, L = low level, X = irrelevant, ? = indeterminate,
Z = high impedance (off)



Please be aware that an important notice concerning availability, standard warranty, and use in critical applications of Texas Instruments semiconductor products and disclaimers thereto appears at the end of this data sheet.

PRODUCTION DATA information is current as of publication date. Products conform to specifications per the terms of Texas Instruments standard warranty. Production processing does not necessarily include testing of all parameters.

 **TEXAS
INSTRUMENTS**

POST OFFICE BOX 655303 • DALLAS, TEXAS 75265

Copyright © 1995, Texas Instruments Incorporated

SN75ALS193 QUADRUPLE DIFFERENTIAL LINE RECEIVER

SLLS008D – JUNE 1986 – REVISED MAY 1995

logic symbol†

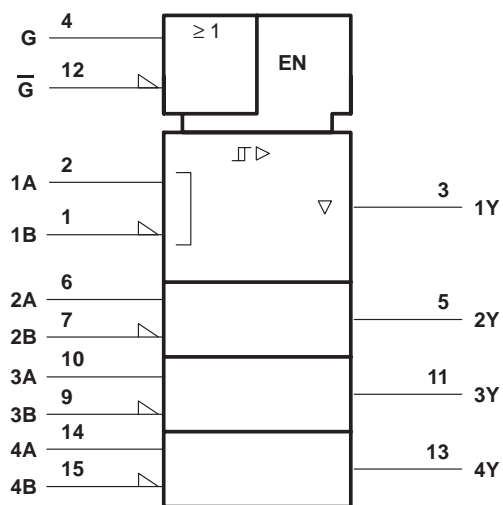

† This symbol is in accordance with ANSI/IEEE Std 91-1984 and IEC Publication 617-12.

logic diagram (positive logic)

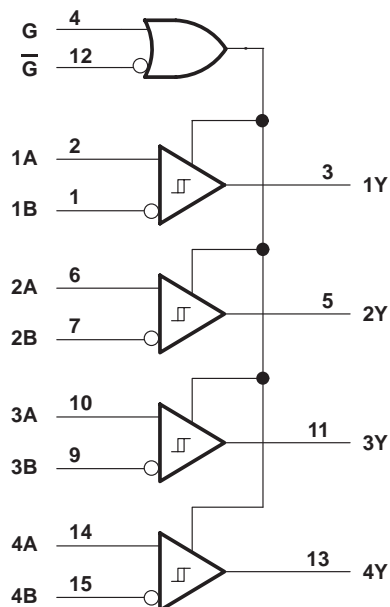

schematics of inputs and outputs

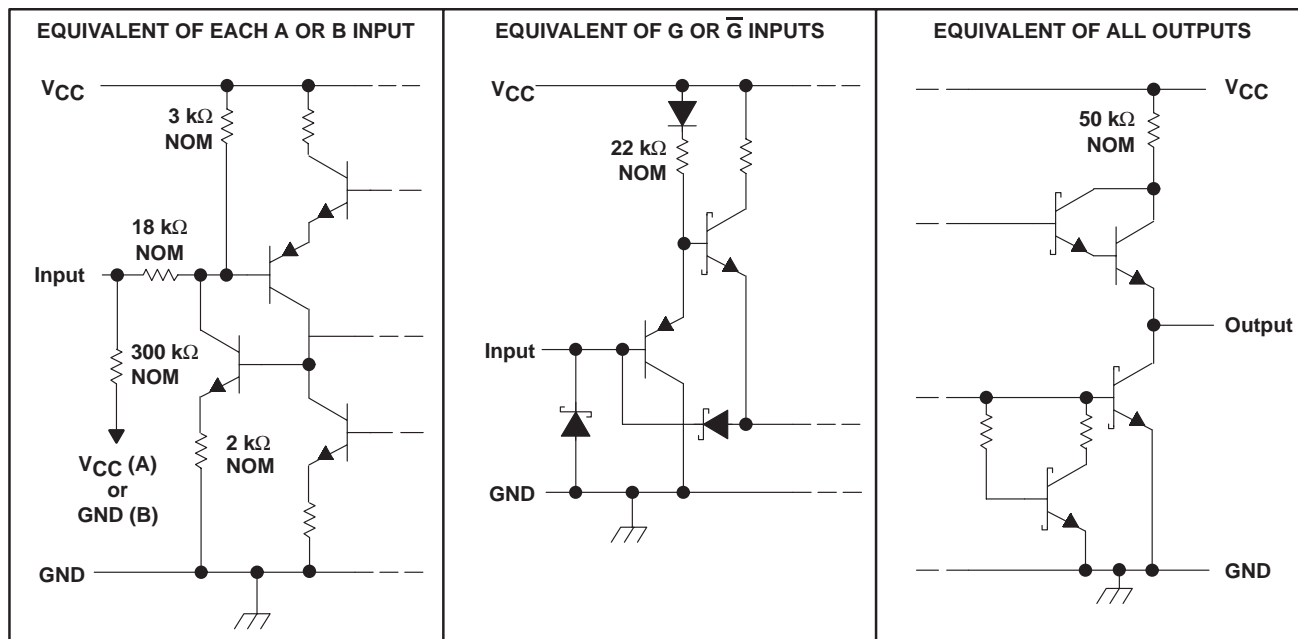

SN75ALS193 QUADRUPLE DIFFERENTIAL LINE RECEIVER

SLLS008D – JUNE 1986 – REVISED MAY 1995

absolute maximum ratings over operating free-air temperature range (unless otherwise noted)[†]

Supply voltage, V_{CC} (see Note 1)	7 V
Input voltage, V_I (A or B)	± 15 V
Differential input voltage, V_{ID} (see Note 2)	± 15 V
Enable input voltage, V_I	7 V
Low-level output current, I_{OL}	50 mA
Continuous total dissipation	See Dissipation Rating Table
Operating free-air temperature range, T_A	0°C to 70°C
Storage temperature range, T_{stg}	-65°C to 150°C
Lead temperature 1,6 mm (1/16 inch) from case for 60 seconds	300°C

[†] Stresses beyond those listed under absolute maximum ratings may cause permanent damage to the device. These are stress ratings only, and functional operation of the device at these or any other conditions beyond those indicated under recommended operating conditions is not implied. Exposure to absolute-maximum-rated conditions for extended periods may affect device reliability.

- NOTES: 1. All voltage values, except differential input voltage, are with respect to network ground terminal.
2. Differential-input voltage is measured at the noninverting input with respect to the corresponding inverting input.

DISSIPATION RATING TABLE

PACKAGE	$T_A \leq 25^\circ\text{C}$ POWER RATING	DERATING FACTOR ABOVE $T_A = 25^\circ\text{C}$	$T_A = 70^\circ\text{C}$ POWER RATING
J	1025 mW	8.2 mW/ $^\circ\text{C}$	656 mW
N	1150 mW	9.2 mW/ $^\circ\text{C}$	736 mW

recommended operating conditions

	MIN	NOM	MAX	UNIT
Supply voltage, V_{CC}	4.75	5	5.25	V
Common-mode input voltage, V_{IC}			± 7	V
Differential input voltage, V_{ID}			± 12	V
High-level input voltage, V_{IH}	2			V
Low-level input voltage, V_{IL}			0.8	V
High-level output current, I_{OH}			-400	μA
Low-level output current, I_{OL}			16	mA
Operating free-air temperature, T_A	0		70	$^\circ\text{C}$



SN75ALS193

QUADRUPLE DIFFERENTIAL LINE RECEIVER

SLLS008D – JUNE 1986 – REVISED MAY 1995

electrical characteristics over recommended range of common-mode input voltage, supply voltage, and operating free-air temperature (unless otherwise noted)

PARAMETER		TEST CONDITIONS†		MIN	TYP‡	MAX	UNIT
V_{IT+}	Positive-going input threshold voltage					200	mV
V_{IT-}	Negative-going input threshold voltage			-200§			mV
V_{hys}	Hysteresis voltage ($V_{IT+} - V_{IT-}$)				120		mV
V_{IK}	Enable-input clamp voltage	$V_{CC} = \text{MIN},$	$I_I = -18 \text{ mA}$			-1.5	V
V_{OH}	High-level output voltage	$V_{CC} = \text{MIN},$ $I_{OH} = -400 \mu\text{A},$	$V_{ID} = 200 \text{ mV},$ See Figure 1	2.5	3.6		V
V_{OL}	Low-level output voltage	$V_{CC} = \text{MIN},$ $V_{ID} = -200 \text{ mV},$ See Figure 1	$I_{OL} = 8 \text{ mA}$			0.45	V
			$I_{OL} = 16 \text{ mA}$			0.5	
I_{OZ}	High-impedance-state output current	$V_{CC} = \text{MAX}$	$V_O = 2.4 \text{ V}$			20	μA
			$V_O = 0.4 \text{ V}$			-20	
I_I	Line input current	Other input at 0, See Note 3	$V_{CC} = \text{MIN},$ $V_I = 15 \text{ V}$		0.7	1.2	mA
			$V_{CC} = \text{MIN},$ $V_I = -15 \text{ V}$		-1.0	-1.7	
I_{IH}	High-level enable-input current	$V_{CC} = \text{MAX}$	$V_{IH} = 2.7 \text{ V}$			20	μA
			$V_{IH} = \text{MAX}$			100	
I_{IL}	Low-level enable-input current	$V_{CC} = \text{MAX},$	$V_{IL} = 0.4 \text{ V}$			-100	μA
	Input resistance			12	18		$k\Omega$
I_{OS}	Short-circuit output current	$V_{CC} = \text{MAX},$ $V_O = 0,$	$V_{ID} = 3 \text{ V},$ See Note 4	-15	-78	-130	mA
I_{CC}	Supply current	$V_{CC} = \text{MAX},$	Outputs disabled		22	35	mA

† For conditions shown as MIN or MAX, use the appropriate values specified under recommended operating conditions.

‡ All typical values are at $V_{CC} = 5 \text{ V}, T_A = 25^\circ\text{C}$.

§ The algebraic convention, in which the less positive limit is designated minimum, is used in this data sheet for threshold voltage levels only.

NOTES: 3. Refer to ANSI Standard EIA/TIA-422-B and EIA/TIA-423-A for exact conditions.

4. Not more than one output should be shorted at a time, and the duration of the short circuit should not exceed one second.

switching characteristics, $V_{CC} = 5 \text{ V}, T_A = 25^\circ\text{C}$

PARAMETER		TEST CONDITIONS		MIN	TYP	MAX	UNIT
t_{PLH}	Propagation delay time, low-to-high-level output	$V_{ID} = -2.5 \text{ V to } 2.5 \text{ V},$ $C_L = 15 \text{ pF},$	See Figure 2		15	22	ns
t_{PHL}	Propagation delay time, high-to-low-level output				15	22	
t_{PZH}	Output enable time to high level	$C_L = 15 \text{ pF},$	See Figure 3		13	25	
t_{PZL}	Output enable time to low level				11	25	
t_{PHZ}	Output disable time from high level	$C_L = 5 \text{ pF},$	See Figure 3		13	25	
t_{PLZ}	Output disable time from low level				15	22	



POST OFFICE BOX 655303 • DALLAS, TEXAS 75265

SN75ALS193 QUADRUPLE DIFFERENTIAL LINE RECEIVER

SLLS008D – JUNE 1986 – REVISED MAY 1995

PARAMETER MEASUREMENT INFORMATION

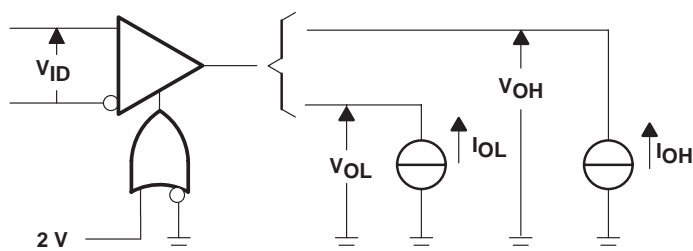
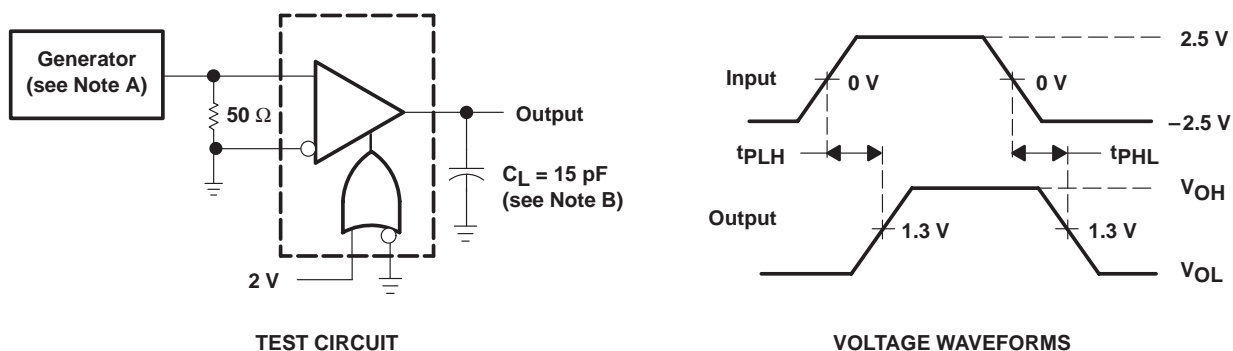

Figure 1. V_{OH} , V_{OL}



- NOTES: A. The input pulse is supplied by a generator having the following characteristics: $PRR \leq 1$ MHz, duty cycle $\leq 50\%$, $Z_O = 50 \Omega$, $t_r \leq 6$ ns, $t_f \leq 6$ ns.
B. C_L includes probe and jig capacitance.

Figure 2. Test Circuit and Voltage Waveforms

SN75ALS193 QUADRUPLE DIFFERENTIAL LINE RECEIVER

SLLS008D – JUNE 1986 – REVISED MAY 1995

PARAMETER MEASUREMENT INFORMATION

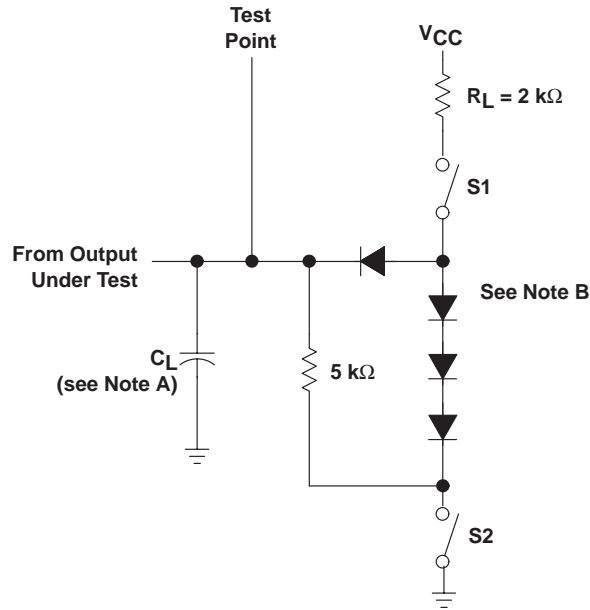

LOAD CIRCUIT

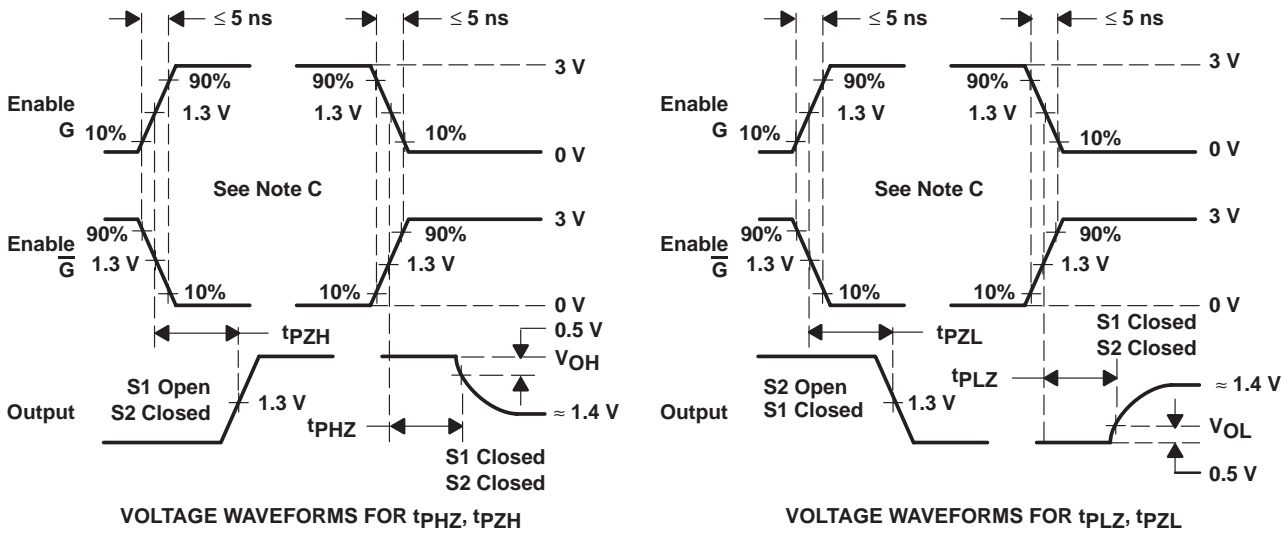

VOLTAGE WAVEFORMS FOR t_{PHZ} , t_{PZH}

VOLTAGE WAVEFORMS FOR t_{PLZ} , t_{PZL}

- NOTES: A. C_L includes probe and jig capacitance.
 B. All diodes are 1N3064 or equivalent.
 C. Enable G is tested with \bar{G} high; G is tested with G low.

Figure 3. Load Circuit and Voltage Waveforms

TYPICAL CHARACTERISTICS

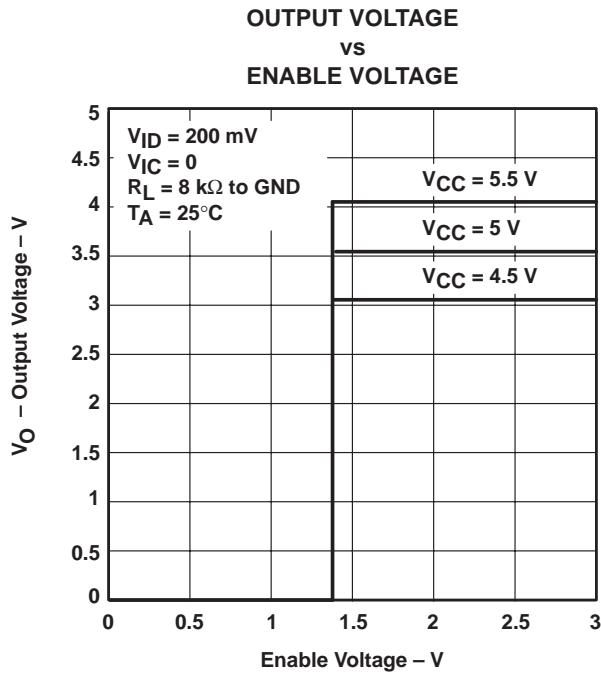

Figure 4

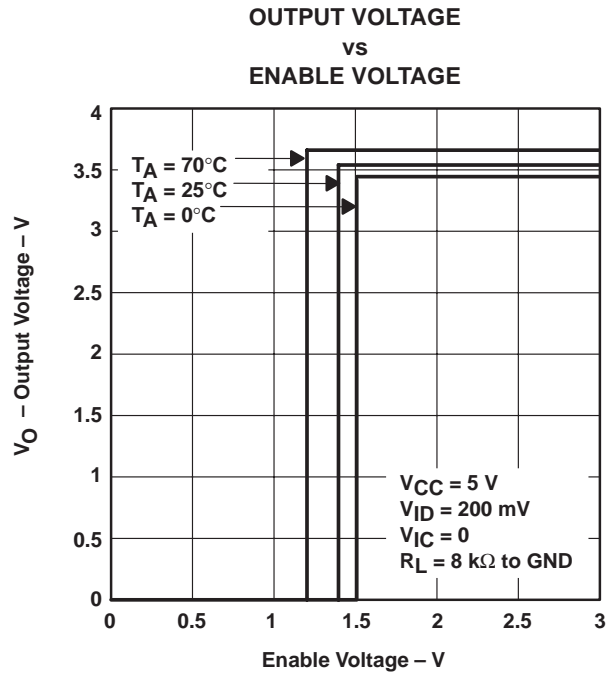

Figure 5

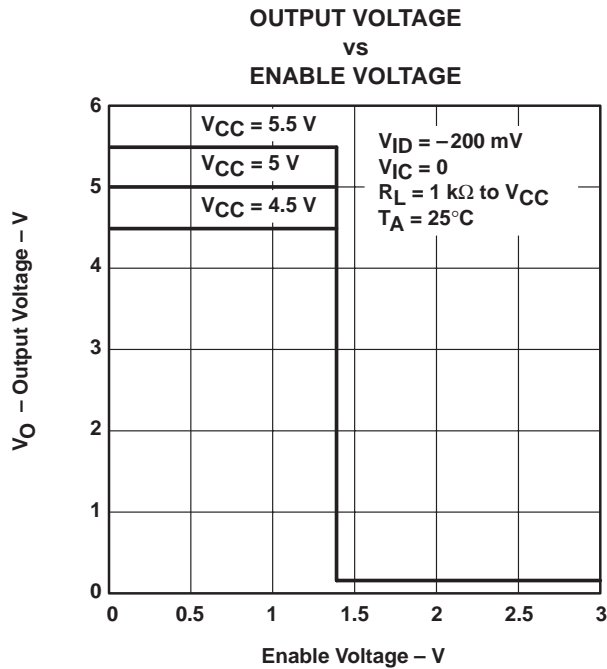

Figure 6

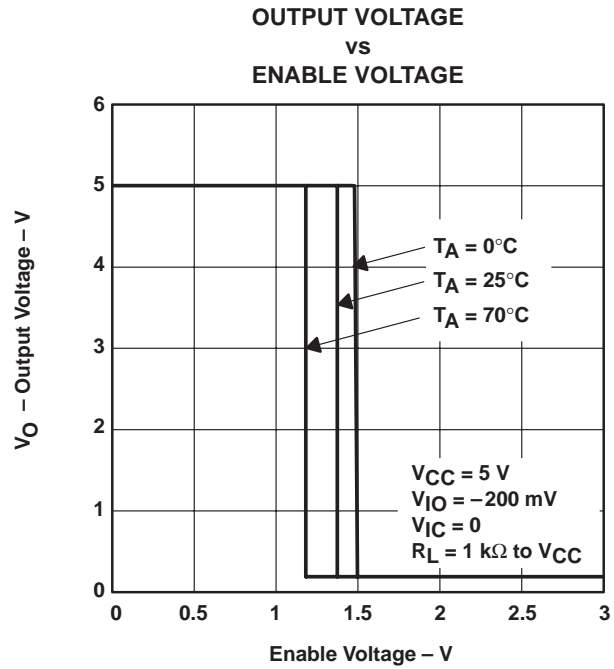

Figure 7

SN75ALS193 QUADRUPLE DIFFERENTIAL LINE RECEIVER

SLLS008D – JUNE 1986 – REVISED MAY 1995

TYPICAL CHARACTERISTICS

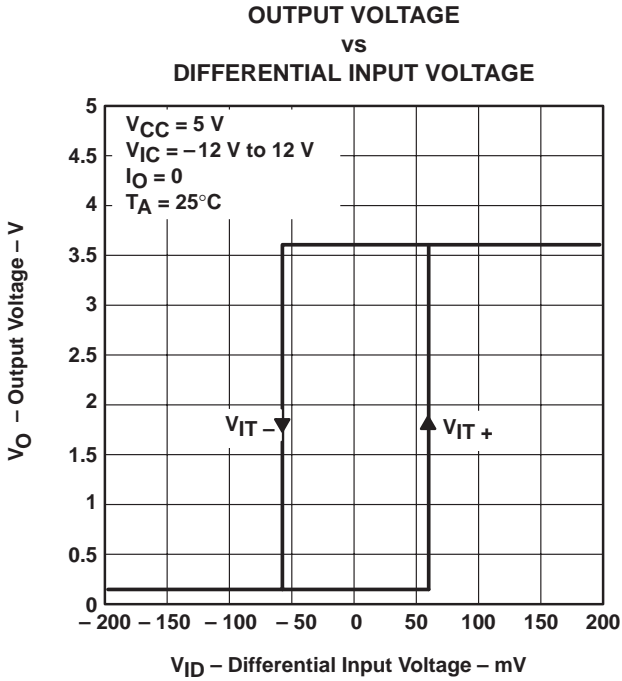

Figure 8

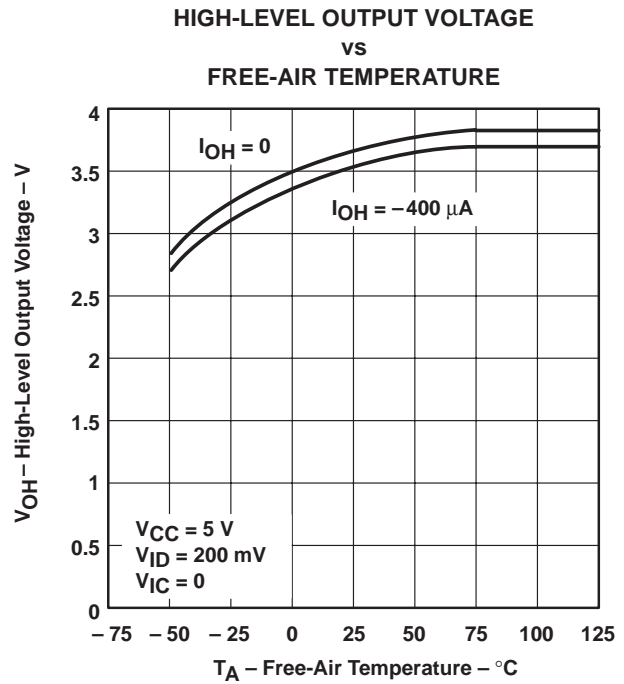

Figure 9

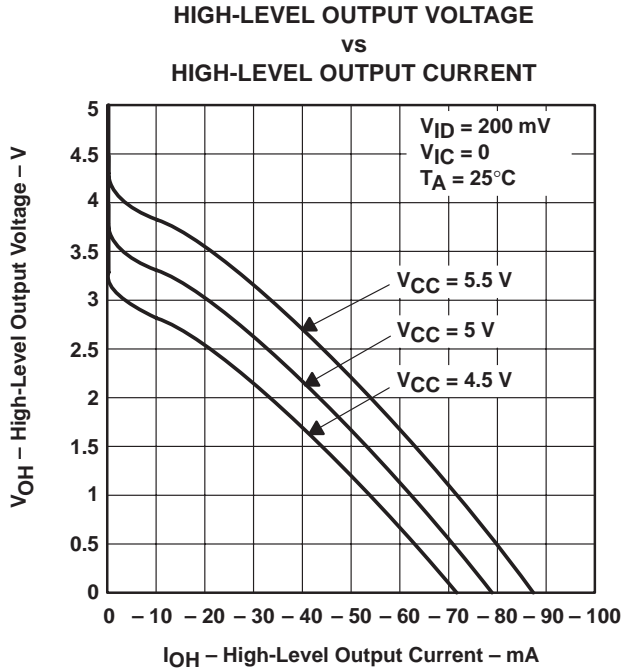

Figure 10

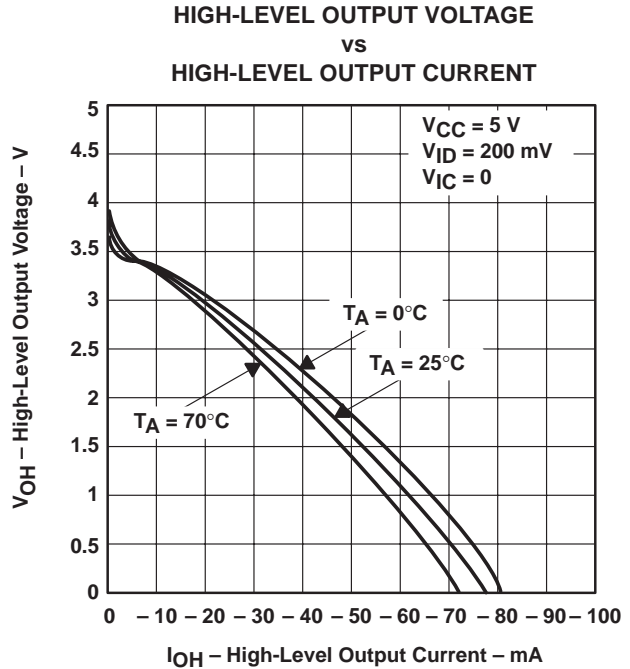

Figure 11

TYPICAL CHARACTERISTICS

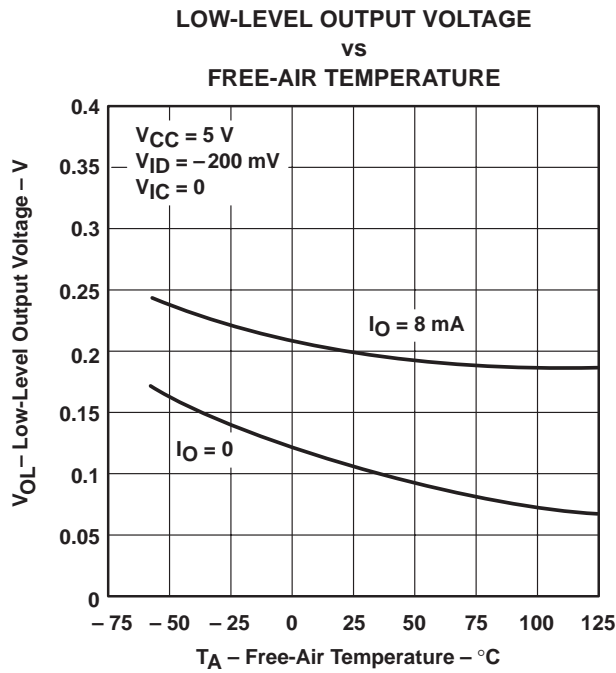

Figure 12

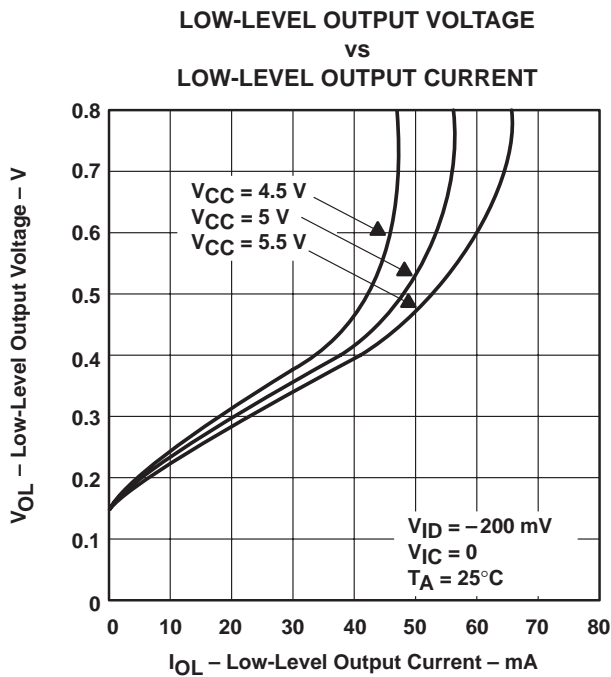

Figure 13

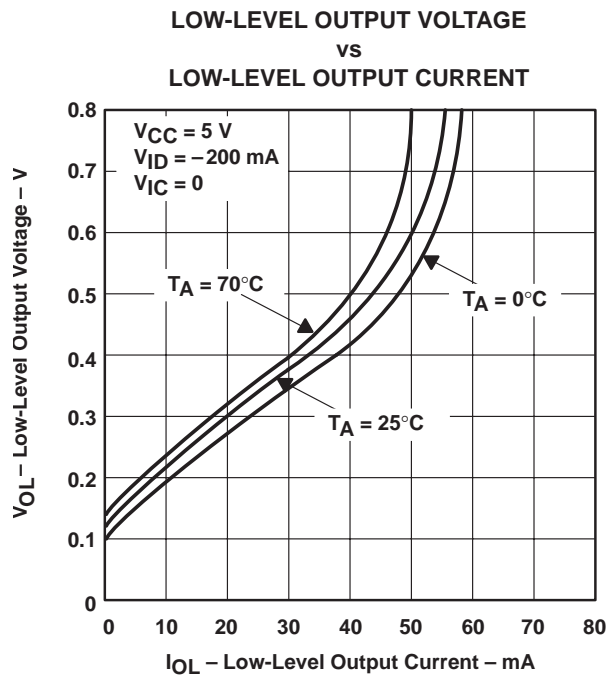

Figure 14

SN75ALS193 QUADRUPLE DIFFERENTIAL LINE RECEIVER

SLLS008D – JUNE 1986 – REVISED MAY 1995

TYPICAL CHARACTERISTICS

SUPPLY CURRENT
vs
SUPPLY VOLTAGE

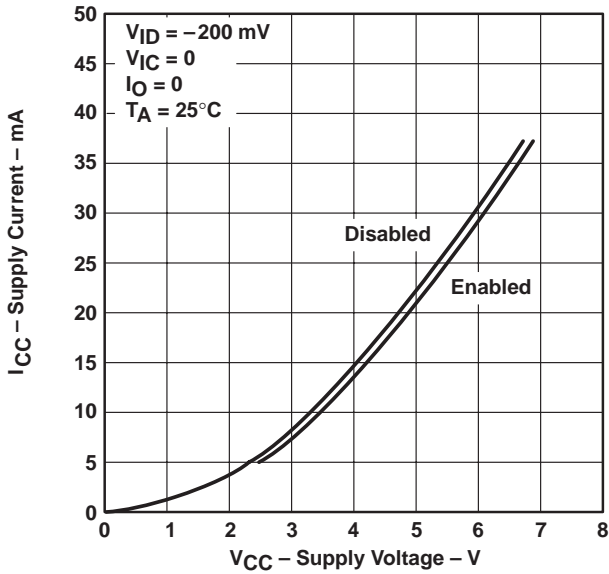

Figure 15

SUPPLY CURRENT
vs
FREE-AIR TEMPERATURE

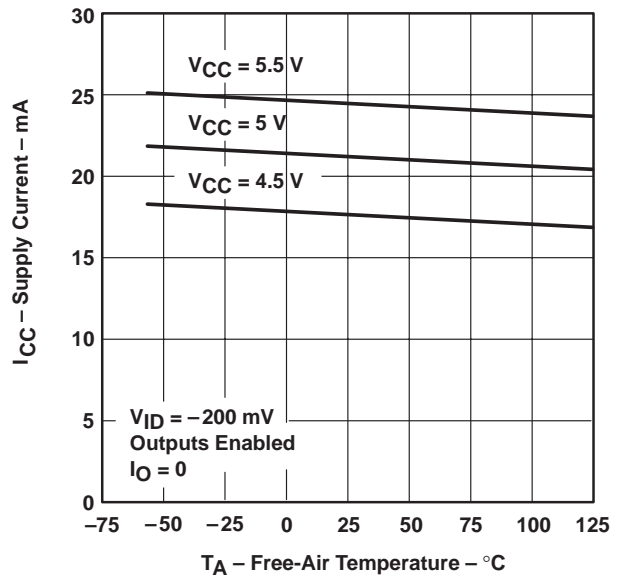

Figure 16

SUPPLY CURRENT
vs
DIFFERENTIAL INPUT VOLTAGE

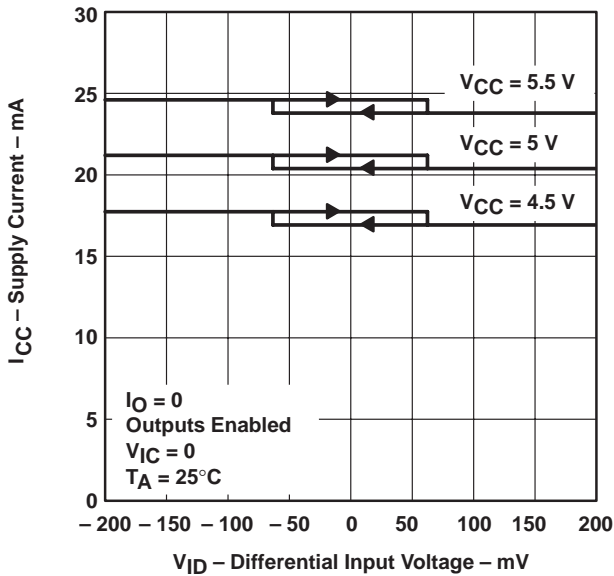

Figure 17

SUPPLY CURRENT
vs
FREQUENCY

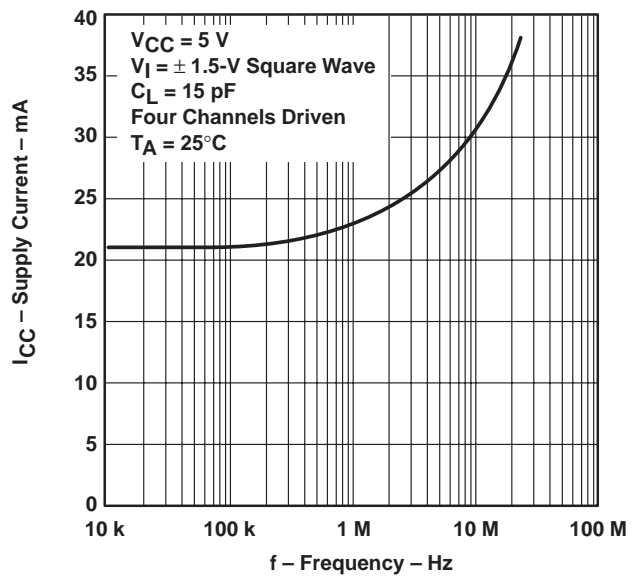

Figure 18



TYPICAL CHARACTERISTICS

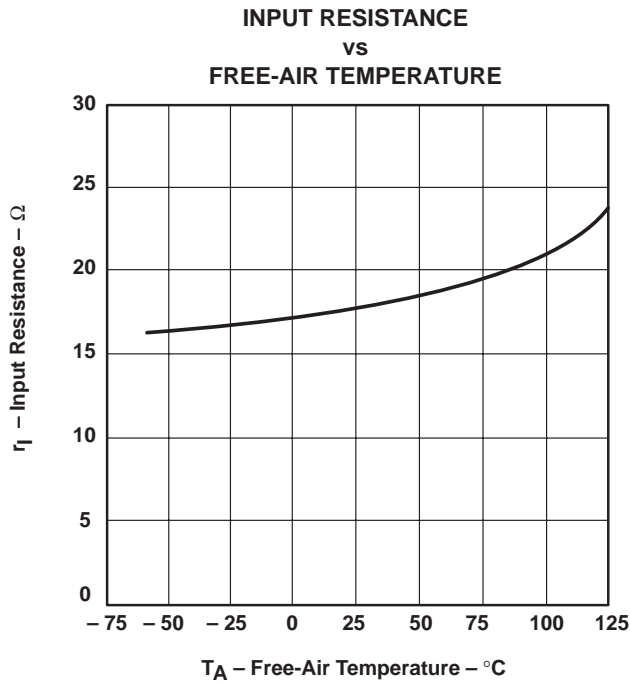

Figure 19

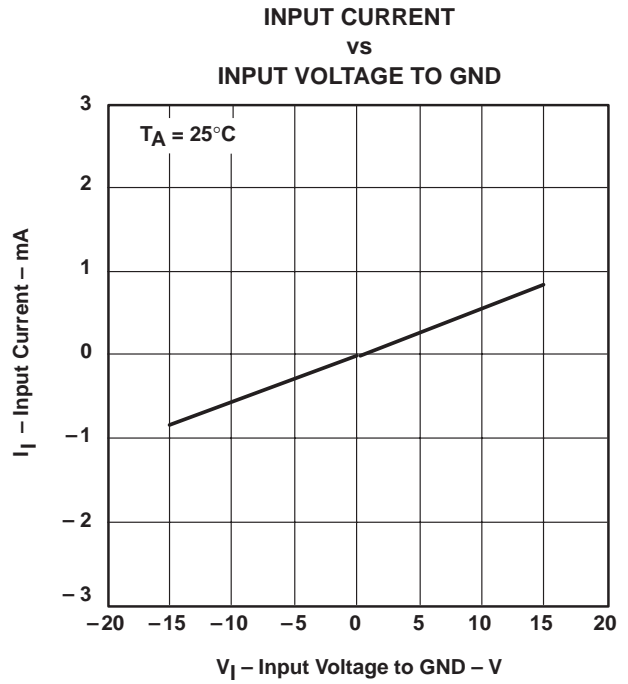

Figure 20

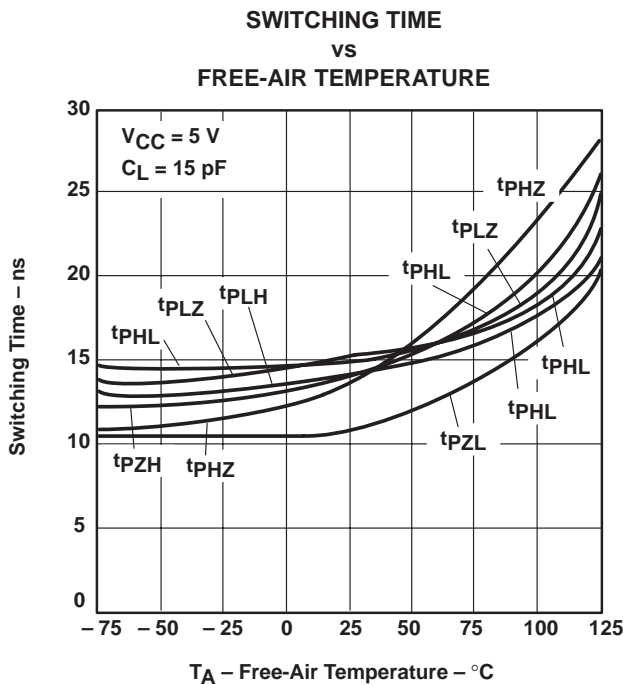

Figure 21

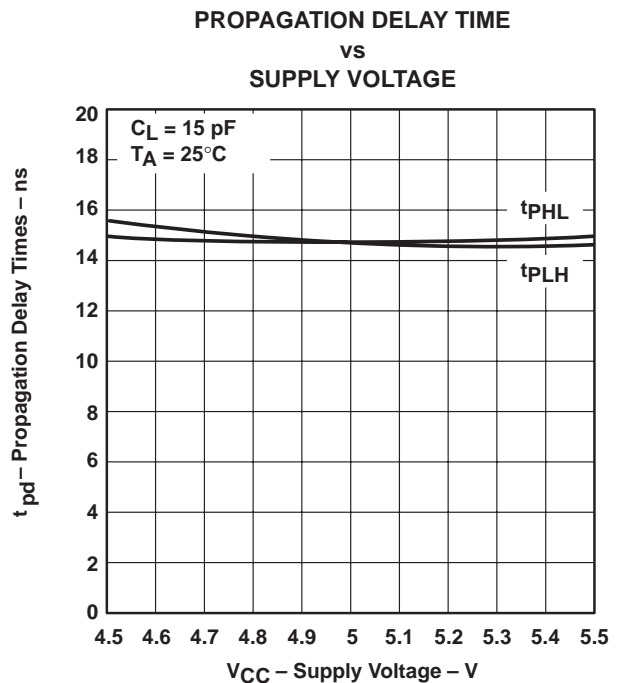

Figure 22

IMPORTANT NOTICE

Texas Instruments and its subsidiaries (TI) reserve the right to make changes to their products or to discontinue any product or service without notice, and advise customers to obtain the latest version of relevant information to verify, before placing orders, that information being relied on is current and complete. All products are sold subject to the terms and conditions of sale supplied at the time of order acknowledgement, including those pertaining to warranty, patent infringement, and limitation of liability.

TI warrants performance of its semiconductor products to the specifications applicable at the time of sale in accordance with TI's standard warranty. Testing and other quality control techniques are utilized to the extent TI deems necessary to support this warranty. Specific testing of all parameters of each device is not necessarily performed, except those mandated by government requirements.

CERTAIN APPLICATIONS USING SEMICONDUCTOR PRODUCTS MAY INVOLVE POTENTIAL RISKS OF DEATH, PERSONAL INJURY, OR SEVERE PROPERTY OR ENVIRONMENTAL DAMAGE ("CRITICAL APPLICATIONS"). TI SEMICONDUCTOR PRODUCTS ARE NOT DESIGNED, AUTHORIZED, OR WARRANTED TO BE SUITABLE FOR USE IN LIFE-SUPPORT DEVICES OR SYSTEMS OR OTHER CRITICAL APPLICATIONS. INCLUSION OF TI PRODUCTS IN SUCH APPLICATIONS IS UNDERSTOOD TO BE FULLY AT THE CUSTOMER'S RISK.

In order to minimize risks associated with the customer's applications, adequate design and operating safeguards must be provided by the customer to minimize inherent or procedural hazards.

TI assumes no liability for applications assistance or customer product design. TI does not warrant or represent that any license, either express or implied, is granted under any patent right, copyright, mask work right, or other intellectual property right of TI covering or relating to any combination, machine, or process in which such semiconductor products or services might be or are used. TI's publication of information regarding any third party's products or services does not constitute TI's approval, warranty or endorsement thereof.