

TPS2300, TPS2301

DUAL HOT SWAP POWER CONTROLLER WITH INDEPENDENT CIRCUIT BREAKER AND POWER-GOOD REPORTING

SLVS265B – FEBRUARY 2000 – REVISED APRIL 2000

features

- Dual-Channel High-Side MOSFET Drivers
- IN1: 3 V to 13 V; IN2: 3 V to 5.5 V
- Inrush Current Limiting With dv/dt Control
- Circuit-Breaker Control With Programmable Current Limit and Transient Timer
- Power-Good Reporting With Transient Filter
- CMOS- and TTL-Compatible Enable Input
- Low, 5- μ A Standby Supply Current . . . Max
- Available in 20-Pin TSSOP Package
- -40°C to 85°C Ambient Temperature Range
- Electrostatic Discharge Protection

applications

- Hot-Swap/Plug/Dock Power Management
- Hot-Plug PCI, Device Bay
- Electronic Circuit Breaker

description

The TPS2300 and TPS2301 are dual-channel hot-swap controllers that use external N-channel MOSFETs as high-side switches in power applications. Features of these devices, such as overcurrent protection (OCP), inrush current control, output-power status reporting, and separation of load transients from actual load increases, are critical requirements for hot-swap applications.

The TPS2300/01 devices incorporate undervoltage lockout (UVLO) and power-good (PG) reporting to ensure the device is off at start-up and confirm the status of the output voltage rails during operation. Each internal charge pump, capable of driving multiple MOSFETs, provides enough gate-drive voltage to fully enhance the N-channel MOSFETs. The charge pumps control both the rise times and fall times (dv/dt) of the MOSFETs, reducing power transients during power up/down. The circuit-breaker functionality combines the ability to sense overcurrent conditions with a timer function; this allows designs such as DSPs, that may have high peak currents during power-state transitions, to disregard transients for a programmable period.

AVAILABLE OPTIONS

T _A	HOT-SWAP CONTROLLER DESCRIPTION	PIN COUNT	TSSOP PACKAGES (PW, PWR)	
			ENABLE	ENABLE
-40°C to 85°C	Dual-channel with independent OCP and adjustable PG	20	TPS2300IPW	TPS2301IPW
	Dual-channel with interdependent OCP and adjustable PG	20	TPS2310IPW	TPS2311IPW
	Dual-channel with independent OCP	16	TPS2320IPW	TPS2321IPW
	Single-channel with OCP and adjustable PG	14	TPS2330IPW	TPS2331IPW

† The packages are available left-end taped and reeled (indicated by the R suffix on the device type; e.g., TPS2301IPWR).



Please be aware that an important notice concerning availability, standard warranty, and use in critical applications of Texas Instruments semiconductor products and disclaimers thereto appears at the end of this data sheet.

PRODUCTION DATA information is current as of publication date. Products conform to specifications per the terms of Texas Instruments standard warranty. Production processing does not necessarily include testing of all parameters.



POST OFFICE BOX 655303 • DALLAS, TEXAS 75265

Copyright © 2000, Texas Instruments Incorporated

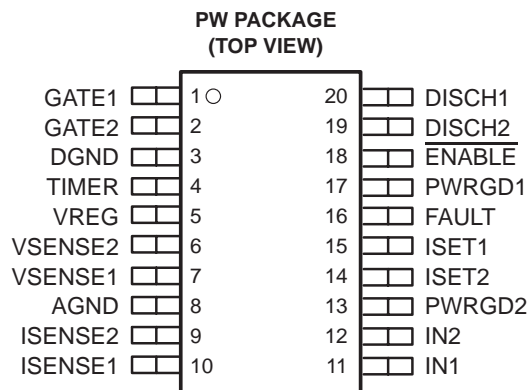

NOTE: Terminal 18 is active high on TPS2301.

typical application

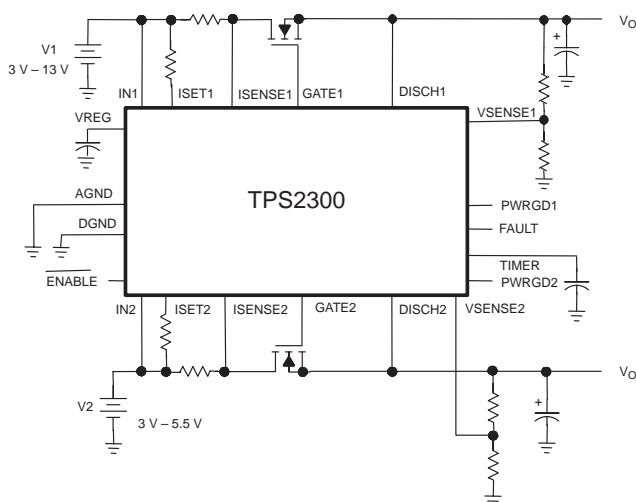

TPS2300, TPS2301 DUAL HOT SWAP POWER CONTROLLER WITH INDEPENDENT CIRCUIT BREAKER AND POWER-GOOD REPORTING

SLVS265B – FEBRUARY 2000 – REVISED APRIL 2000

functional block diagram

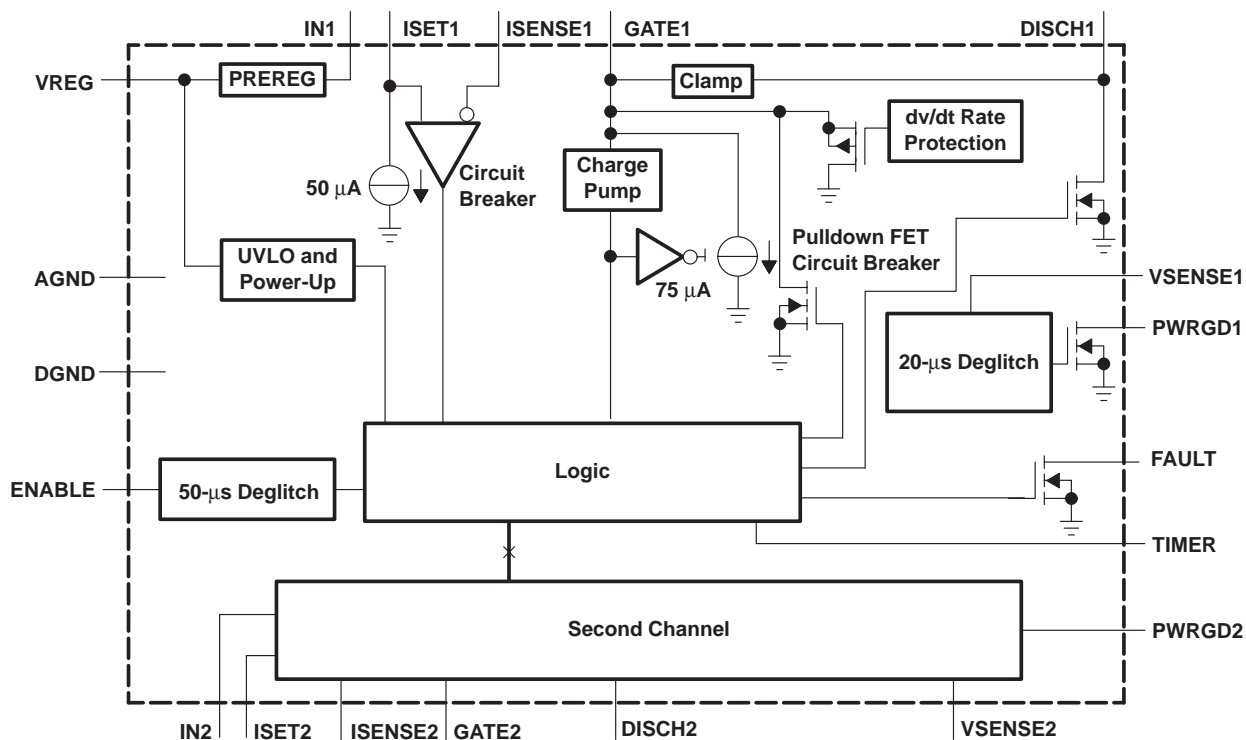

Terminal Functions

TERMINAL NAME	NO.	I/O	DESCRIPTION
AGND	8	I	Analog ground, connects to DGND as close as possible
DGND	3	I	Digital ground
DISCH1	20	O	Discharge transistor 1
DISCH2	19	O	Discharge transistor 2
ENABLE/ ENABLE	18	I	Active low (TPS2300) or active high enable (TPS2301)
FAULT	16	O	Overcurrent fault, open-drain output
GATE1	1	O	Connects to gate of channel 1 high-side MOSFET
GATE2	2	O	Connects to gate of channel 2 high-side MOSFET
IN1	11	I	Input voltage for channel 1
IN2	12	I	Input voltage for channel 2
ISENSE1	10	I	Current-sense input channel 1
ISENSE2	9	I	Current-sense input channel 2
ISET1	15	I	Adjusts circuit-breaker threshold with resistor connected to IN1
ISET2	14	I	Adjusts circuit-breaker threshold with resistor connected to IN2
PWRGD1	17	O	Open-drain output, asserted low when VSENSE1 voltage is less than reference.
PWRGD2	13	O	Open-drain output, asserted low when VSENSE2 voltage is less than reference.
TIMER	4	O	Adjusts circuit-breaker deglitch time
VREG	5	O	Connects to bypass capacitor, for stable operation
VSENSE1	7	I	Power-good sense input channel 1
VSENSE2	6	I	Power-good sense input channel 2



POST OFFICE BOX 655303 • DALLAS, TEXAS 75265

TPS2300, TPS2301 DUAL HOT SWAP POWER CONTROLLER WITH INDEPENDENT CIRCUIT BREAKER AND POWER-GOOD REPORTING

SLVS265B – FEBRUARY 2000 – REVISED APRIL 2000

detailed description

DISCH1, DISCH2 – DISCH1 and DISCH2 should be connected to the sources of the external N-channel MOSFET transistors connected to GATE1 and GATE2, respectively. These pins discharge the loads when the MOSFET transistors are disabled. They also serve as reference-voltage connections for internal gate voltage-clamp circuitry.

ENABLE or ENABLER – $\overline{\text{ENABLE}}$ for TPS2300 is active low. ENABLE for TPS2301 is active high. When the controller is enabled, both GATE1 and GATE2 voltages will power up to turn on the external MOSFETs. When the $\overline{\text{ENABLE}}$ pin is pulled high for TPS2300 or the ENABLE pin is pulled low for TPS2301 for more than 50 μs , the gate of the MOSFET is discharged at a controlled rate by a current source, and a transistor is enabled to discharge the output bulk capacitance. In addition, the device turns on the internal regulator PREREG (see VREG) when enabled and shuts down PREREG when disabled so that total supply current is less than 5 μA .

FAULT – FAULT is an open-drain overcurrent flag output. When an overcurrent condition in either channel is sustained long enough to charge TIMER to 0.5 V, the overcurrent channel latches off and pulls this pin low. The other channel will run normally if not in overcurrent.

GATE1, GATE2 – GATE1 and GATE2 connect to the gates of external N-channel MOSFET transistors. When the device is enabled, internal charge-pump circuitry pulls these pins up by sourcing approximately 15 μA to each. The turnon slew rates depend upon the capacitance present at the GATE1 and GATE2 terminals. If desired, the turnon slew rates can be further reduced by connecting capacitors between these pins and ground. These capacitors also reduce inrush current and protect the device from false overcurrent triggering during powerup. The charge-pump circuitry will generate gate-to-source voltages of 9 V–12 V across the external MOSFET transistors.

IN1, IN2 – IN1 and IN2 should be connected to the power sources driving the external N-channel MOSFET transistors connected to GATE1 and GATE2, respectively. The TPS2300/TPS2301 draws its operating current from IN1, and both channels will remain disabled until the IN1 power supply has been established. The IN1 channel has been constructed to support 3-V, 5-V, or 12-V operation, while the IN2 channel has been constructed to support 3-V or 5-V operation.

ISENSE1, ISENSE2, ISET1, ISET2 – ISENSE1 and ISENSE2, in combination with ISET1 and ISET2, implement overcurrent sensing for GATE1 and GATE2. ISET1 and ISET2 set the magnitude of the current that generates an overcurrent fault, through external resistors connected to ISET1 and ISET2. An internal current source draws 50 μA from ISET1 and ISET2. With a sense resistor from IN1 to ISENSE1 or from IN2 to ISENSE2, which is also connected to the drains of external MOSFETs, the voltage on the sense resistor reflects the load current. An overcurrent condition is assumed to exist if ISENSE1 is pulled below ISET1 or if ISENSE2 is pulled below ISET2.

PWRGD1, PWRGD2 – PWRGD1 and PWRGD2 signal the presence of undervoltage conditions on VSENSE1 and VSENSE2, respectively. These pins are open-drain outputs and are pulled low during an undervoltage condition. To minimize erroneous PWRGDx responses from transients on the voltage rail, the voltage sense circuit incorporates a 20- μs deglitch filter. When VSENSEx is lower than the reference voltage (about 1.23 V), PWRGDx will be active low to indicate an undervoltage condition on the power-rail voltage.

TIMER – A capacitor on TIMER sets the time during which the power switch can be in overcurrent before turning off. When the overcurrent protection circuits sense an excessive current, a current source is enabled which charges the capacitor on TIMER. Once the voltage on TIMER reaches approximately 0.5 V, the circuit-breaker latch is set and the power switch is latched off. Power must be recycled or the ENABLE pin must be toggled to restart the controller. In high-power or high-temperature applications, a minimum 50-pF capacitor is strongly recommended from TIMER to ground, to prevent any false triggering.

VREG – The VREG pin is the output of an internal low-dropout voltage regulator. This regulator draws current from IN1. A 0.1- μF ceramic capacitor should be connected between VREG and ground. VREG can be connected to IN1, IN2, or to a separated power supply through a low-resistance resistor. However, the voltage on VREG must be less than 5.5 V.



TPS2300, TPS2301

DUAL HOT SWAP POWER CONTROLLER WITH INDEPENDENT CIRCUIT BREAKER AND POWER-GOOD REPORTING

SLVS265B – FEBRUARY 2000 – REVISED APRIL 2000

detailed description (continued)

VSENSE1, VSENSE2 – VSENSE1 and VSENSE2 can be used to detect undervoltage conditions on external circuitry. If VSENSE1 senses a voltage below approximately 1.23 V, PWRGD1 is pulled low. Similarly, a voltage less than 1.23 V on VSENSE2 causes PWRGD2 to be pulled low.

absolute maximum ratings over operating free-air temperature (unless otherwise noted)†

Input voltage range:	$V_{I(IN1)}, V_{I(ISENSE1)}, V_{I(VSENSE1)}, V_{I(VSENSE2)}, V_{I(ISET1)}, V_{I(ENABLE)}$	–0.3 V to 15 V
	$V_{I(IN2)}, V_{I(ISENSE2)}, V_{I(ISET2)}$	–0.3 V to 7 V
Output voltage range:	$V_{O(GATE1)}, V_{O(GATE2)}$	–0.3 V to 30 V
	$V_{O(DISCH1)}, V_{O(PWRGD1)}, V_{O(PWRGD2)}, V_{O(FAULT)}, V_{O(VREG)}, V_{O(DISCH2)}, V_{O(TIMER)}$	–0.3 V to 15 V
Sink current range:	$I_{GATE1}, I_{GATE2}, I_{DISCH1}, I_{DISCH2}$	0 mA to 100 mA
	$I_{PWRGD1}, I_{PWRGD2}, I_{TIMER}, I_{FAULT}$	0 mA to 10 mA
Operating virtual junction temperature range, T_J		–40°C to 100°C
Storage temperature range, T_{stg}		–55°C to 150°C
Lead temperature 1,6 mm (1/16 inch) from case for 10 seconds		260°C

† Stresses beyond those listed under “absolute maximum ratings” may cause permanent damage to the device. These are stress ratings only, and functional operation of the device at these or any other conditions beyond those indicated under “recommended operating conditions” is not implied. Exposure to absolute-maximum-rated conditions for extended periods may affect device reliability.

NOTE 1: All voltages are respect to DGND.

DISSIPATION RATING TABLE

PACKAGE	$T_A \leq 25^\circ\text{C}$ POWER RATING	DERATING FACTOR ABOVE $T_A = 25^\circ\text{C}$	$T_A = 70^\circ\text{C}$ POWER RATING	$T_A = 85^\circ\text{C}$ POWER RATING
PW-20	1015 mW	13.55 mW/°C	406 mW	203 mW

recommended operating conditions

		MIN	NOM	MAX	UNIT
Input voltage, V_I	$V_{I(IN1)}, V_{I(ISENSE1)}, V_{I(VSENSE1)}, V_{I(VSENSE2)}, V_{I(ISET1)}$	3		13	V
	$V_{I(IN2)}, V_{I(ISENSE2)}, V_{I(ISET2)}$	3		5.5	
VREG voltage, $V_{O(VREG)}$, when VREG is directly connected to IN1		2.95		5.5	V
Operating virtual junction temperature, T_J		–40		100	°C



TPS2300, TPS2301
**DUAL HOT SWAP POWER CONTROLLER WITH INDEPENDENT
CIRCUIT BREAKER AND POWER-GOOD REPORTING**

SLVS265B – FEBRUARY 2000 – REVISED APRIL 2000

**electrical characteristics over recommended operating temperature range ($-40^{\circ}\text{C} < T_A < 85^{\circ}\text{C}$),
 $3\text{ V} \leq V_{I(IN1)} \leq 13\text{ V}$, $3\text{ V} \leq V_{I(IN2)} \leq 5.5\text{ V}$ (unless otherwise noted)**

general

PARAMETER		TEST CONDITIONS	MIN	TYP	MAX	UNIT
$I_{I(IN1)}$	Input current, IN1	$V_{I(ENABLE)} = 5\text{ V}$ (TPS2301), $V_{I(ENABLE)} = 0\text{ V}$ (TPS2300)		0.5	1	mA
$I_{I(IN2)}$	Input current, IN2			75	200	μA
$I_{I(stby)}$	Standby current (sum of currents into IN1, IN2, ISENSE1, ISENSE2, ISET1, and ISET2)	$V_{I(ENABLE)} = 0\text{ V}$ (TPS2301) $V_{I(ENABLE)} = 5\text{ V}$ (TPS2300)			5	μA

GATE1

PARAMETER		TEST CONDITIONS	MIN	TYP	MAX	UNIT
$V_{G(GATE1_3V)}$	Gate voltage	$I_{I(GATE1)} = 500\text{ nA}$, DISCH1 open	$V_{I(IN1)} = 3\text{ V}$	9	11.5	V
$V_{G(GATE1_4.5V)}$			$V_{I(IN1)} = 4.5\text{ V}$	10.5	14.5	
$V_{G(GATE1_10.8V)}$			$V_{I(IN1)} = 10.8\text{ V}$	16.8	21	
$V_{C(GATE1)}$	Clamping voltage, GATE1 to DISCH1		9	10	12	V
$I_{S(GATE1)}$	Source current, GATE1	$3\text{ V} \leq V_{I(IN1)} \leq 13.2\text{ V}$, $3\text{ V} \leq V_{O(VREG)} \leq 5.5\text{ V}$, $V_{I(GATE1)} = V_{I(IN1)} + 6\text{ V}$	10	14	20	μA
	Sink current, GATE1	$3\text{ V} \leq V_{I(IN1)} \leq 13.2\text{ V}$, $3\text{ V} \leq V_{O(VREG)} \leq 5.5\text{ V}$, $V_{I(GATE1)} = V_{I(IN1)}$	50	75	100	μA
$t_{r(GATE1)}$	Rise time, GATE1	C_g to GND = 1 nF (see Note 2)	$V_{I(IN1)} = 3\text{ V}$	0.5		ms
			$V_{I(IN1)} = 4.5\text{ V}$	0.6		
			$V_{I(IN1)} = 10.8\text{ V}$	1		
$t_{f(GATE1)}$	Fall time, GATE1	C_g to GND = 1 nF (see Note 2)	$V_{I(IN1)} = 3\text{ V}$	0.1		ms
			$V_{I(IN1)} = 4.5\text{ V}$	0.12		
			$V_{I(IN1)} = 10.8\text{ V}$	0.2		

GATE2

PARAMETER		TEST CONDITIONS	MIN	TYP	MAX	UNIT
$V_{G(GATE2_3V)}$	Gate voltage	$I_{I(GATE2)} = 500\text{ nA}$, DISCH2 open	$V_{I(IN2)} = 3\text{ V}$	9	11.7	V
$V_{G(GATE2_4.5V)}$			$V_{I(IN2)} = 4.5\text{ V}$	10.5	14.7	
$V_{C(GATE2)}$	Clamping voltage, GATE2 to DISCH2		9	10	12	V
$I_{S(GATE2)}$	Source current, GATE2	$3\text{ V} \leq V_{I(IN2)} \leq 5.5\text{ V}$, $3\text{ V} \leq V_{O(VREG)} \leq 5.5\text{ V}$, $V_{I(GATE2)} = V_{I(IN2)} + 6\text{ V}$	10	14	20	μA
	Sink current, GATE2	$3\text{ V} \leq V_{I(IN2)} \leq 5.5\text{ V}$, $3\text{ V} \leq V_{O(VREG)} \leq 5.5\text{ V}$, $V_{I(GATE2)} = V_{I(IN2)}$	50	75	100	μA
$t_{r(GATE2)}$	Rise time, GATE2	C_g to GND = 1 nF (see Note 2)	$V_{I(IN2)} = 3\text{ V}$	0.5		ms
			$V_{I(IN2)} = 4.5\text{ V}$	0.6		
$t_{f(GATE2)}$	Fall time, GATE2	C_g to GND = 1 nF (see Note 2)	$V_{I(IN2)} = 3\text{ V}$	0.1		ms
			$V_{I(IN2)} = 4.5\text{ V}$	0.12		

NOTE 2: Specified, but not production tested.



TPS2300, TPS2301

DUAL HOT SWAP POWER CONTROLLER WITH INDEPENDENT CIRCUIT BREAKER AND POWER-GOOD REPORTING

SLVS265B – FEBRUARY 2000 – REVISED APRIL 2000

electrical characteristics over recommended operating temperature range ($-40^{\circ}\text{C} < T_A < 85^{\circ}\text{C}$), $3\text{ V} \leq V_{I(IN1)} \leq 13\text{ V}$, $3\text{ V} \leq V_{I(IN2)} \leq 5.5\text{ V}$ (unless otherwise noted) (continued)

TIMER

PARAMETER	TEST CONDITIONS	MIN	TYP	MAX	UNIT
$V_{OT(TIMER)}$ Threshold voltage, TIMER		0.4	0.5	0.6	V
Charge current, TIMER	$V_{I(TIMER)} = 0\text{ V}$	35	50	65	μA
Discharge current, TIMER	$V_{I(TIMER)} = 1\text{ V}$	1	2.5		mA

circuit breaker

PARAMETER	TEST CONDITIONS	MIN	TYP	MAX	UNIT
$V_{IT(CB)}$ Undervoltage voltage, circuit breaker	$R_{ISETx} = 1\text{ k}\Omega$	40	50	60	mV
$I_{IB(ISENSEx)}$ Input bias current, I_{SENSEx}			0.1	5	μA
Discharge current, GATE _x	$V_{O(GATEx)} = 4\text{ V}$	400	800		mA
	$V_{O(GATEx)} = 1\text{ V}$	25	150		
$t_{pd(CB)}$ Propagation (delay) time, comparator inputs to gate output	$C_G = 50\text{ pF}$, 10 mV overdrive, $C_{O(timer)} = 50\text{ pF}$ (50% to 10%)		1.3		μs

ENABLE, active low (TPS2300)

PARAMETER	TEST CONDITIONS	MIN	TYP	MAX	UNIT
$V_{IH(\overline{ENABLE})}$ High-level input voltage, \overline{ENABLE}		2			V
$V_{IL(\overline{ENABLE})}$ Low-level input voltage, \overline{ENABLE}				0.8	V
$R_{I(\overline{ENABLE})}$ Input pullup resistance, \overline{ENABLE}	See Note 3	100	200	300	$\text{k}\Omega$
$t_{d_off(\overline{ENABLE})}$ Turnoff delay time, \overline{ENABLE}	$V_{I(\overline{ENABLE})}$ increasing above stop threshold; 100 ns rise time, 20 mV overdrive (see Note 2)		60		μs
$t_{d_on(\overline{ENABLE})}$ Turnon delay time, \overline{ENABLE}	$V_{I(\overline{ENABLE})}$ decreasing below start threshold; 100 ns fall time, 20 mV overdrive (see Note 2)		125		μs

NOTES: 2. Specified, but not production tested.

3. Test I_O of \overline{ENABLE} at $V_{I(\overline{ENABLE})} = 1\text{ V}$ and 0 V , then $R_{I(\overline{ENABLE})} = \frac{1\text{ V}}{I_{O_0V} - I_{O_1V}}$

ENABLE, active high (TPS2301)

PARAMETER	TEST CONDITIONS	MIN	TYP	MAX	UNIT
$V_{IH(ENABLE)}$ High-level input voltage, ENABLE		2			V
$V_{IL(ENABLE)}$ Low-level input voltage, ENABLE				0.7	V
$R_{I(ENABLE)}$ Input pulldown resistance, ENABLE		100	150	300	$\text{k}\Omega$
$t_{d_on(ENABLE)}$ Turnon delay time, ENABLE	$V_{I(ENABLE)}$ increasing above start threshold; 100 ns rise time, 20 mV overdrive (see Note 2)		85		μs
$t_{d_off(ENABLE)}$ Turnoff delay time, ENABLE	$V_{I(ENABLE)}$ decreasing below stop threshold; 100 ns fall time, 20 mV overdrive (see Note 2)		100		μs

NOTE 2: Specified, but not production tested.

PREREG

PARAMETER	TEST CONDITIONS	MIN	TYP	MAX	UNIT
VREG PREREG output voltage	$4.5 \leq V_{I(IN1)} \leq 13\text{ V}$	3.5	4.1	5.5	V
Vdrop_PREREG PREREG dropout voltage	$V_{I(IN1)} = 3\text{ V}$			0.1	V



TPS2300, TPS2301
**DUAL HOT SWAP POWER CONTROLLER WITH INDEPENDENT
 CIRCUIT BREAKER AND POWER-GOOD REPORTING**

SLVS265B – FEBRUARY 2000 – REVISED APRIL 2000

**electrical characteristics over recommended operating temperature range ($-40^{\circ}\text{C} < T_A < 85^{\circ}\text{C}$),
 $3\text{ V} \leq V_{I(IN1)} \leq 13\text{ V}$, $3\text{ V} \leq V_{I(IN2)} \leq 5.5\text{ V}$ (unless otherwise noted) (continued)**

VREG UVLO

PARAMETER	TEST CONDITIONS	MIN	TYP	MAX	UNIT
$V_{OT(UVLOstart)}$ Output threshold voltage, start		2.75	2.85	2.95	V
$V_{OT(UVLOstop)}$ Output threshold voltage, stop		2.65	2.78		V
$V_{hys(UVLO)}$ Hysteresis		50	75		mV
UVLO sink current, GATE _x	$V_{I(GATEx)} = 2\text{ V}$	10			mA

PWRGD1 and PWRGD2

PARAMETER	TEST CONDITIONS	MIN	TYP	MAX	UNIT
$V_{IT(ISENSEx)}$ Trip threshold, VSENSE _x	$V_{I(VSENSEx)}$ decreasing	1.2	1.225	1.25	V
V_{hys} Hysteresis voltage, power-good comparator		20	30	40	mV
$V_{O(sat)(PWRGDx)}$ Output saturation voltage PWRGD _x	$I_O = 2\text{ mA}$		0.2	0.4	V
$V_{O(VREGmin)}$ Minimum $V_{O(VREG)}$ for valid power-good	$I_O = 100\text{ }\mu\text{A}$, $V_{O(PWRGDx)} = 1\text{ V}$			1	V
I_{IB} Input bias current, power-good comparator	$V_{I(VSENSEx)} = 5.5\text{ V}$			1	μA
$I_{lkg(PWRGDx)}$ Leakage current, PWRGD _x	$V_{O(PWRGDx)} = 13\text{ V}$			1	μA
t_{dr} Delay time, rising edge, PWRGD _x	$V_{I(VSENSEx)}$ increasing, Overdrive = 20 mV, $t_r = 100\text{ ns}$, See Note 2		25		μs
t_{df} Delay time, falling edge, PWRGD _x	$V_{I(VSENSEx)}$ decreasing, Overdrive = 20 mV, $t_r = 100\text{ ns}$, See Note 2		2		μs

NOTE 2: Specified, but not production tested.

FAULT output

PARAMETER	TEST CONDITIONS	MIN	TYP	MAX	UNIT
$V_{O(sat)(FAULT)}$ Output saturation voltage, FAULT	$I_O = 2\text{ mA}$			0.4	V
$I_{lkg(FAULT)}$ Leakage current, FAULT	$V_{O(FAULT)} = 13\text{ V}$			1	μA

DISCH1 and DISCH2

PARAMETER	TEST CONDITIONS	MIN	TYP	MAX	UNIT
I_{DISCH} Discharge current, DISCH _x	$V_{I(DISCHx)} = 1.5\text{ V}$, $V_{I(VIN1)} = 5\text{ V}$	5	10		mA
$V_{IH(DISCH)}$ Discharge on high-level input voltage		2			V
$V_{IL(DISCH)}$ Discharge on low-level input voltage				1	V



PARAMETER MEASUREMENT INFORMATION

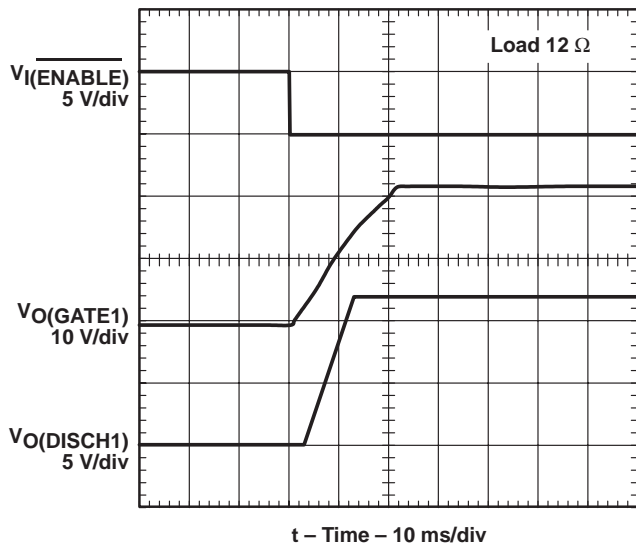

Figure 1. Turnon Voltage Transition of Channel 1

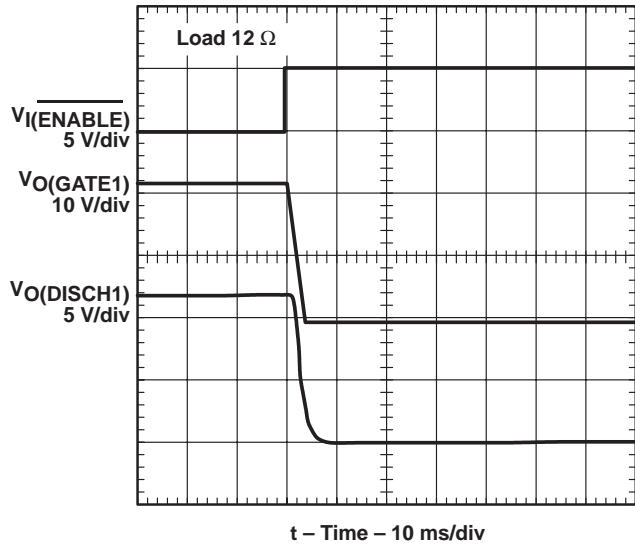

Figure 2. Turnoff Voltage Transition of Channel 1

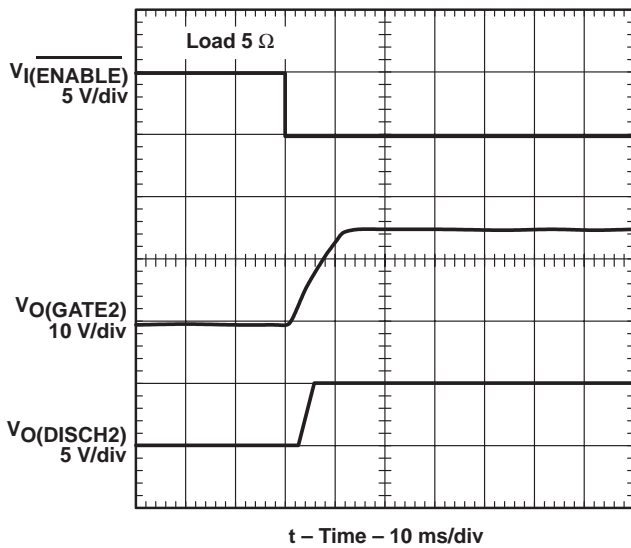

Figure 3. Turnon Voltage Transition of Channel 2

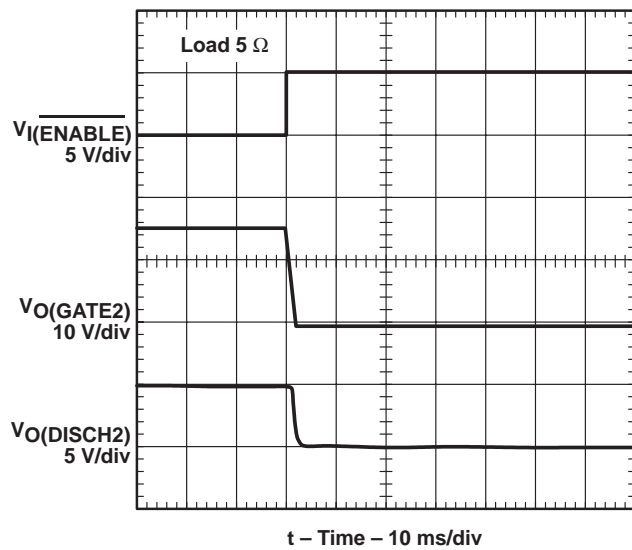
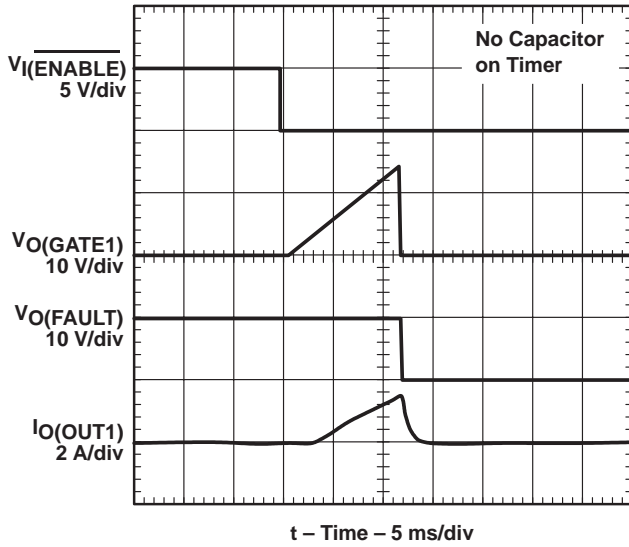
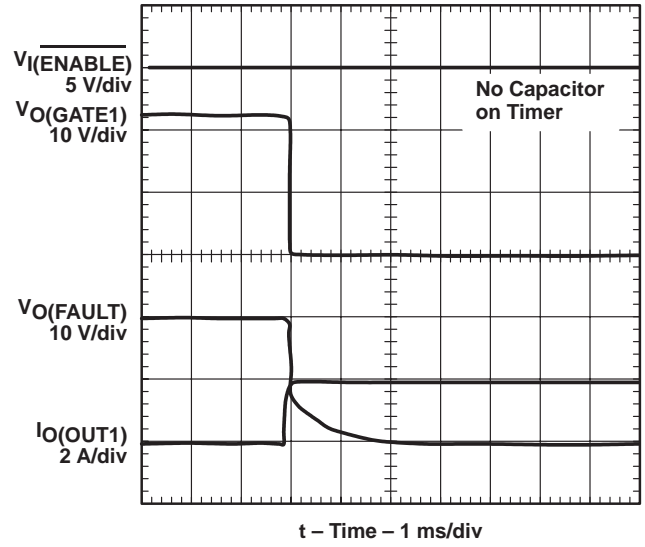

Figure 4. Turnoff Voltage Transition of Channel 2

PARAMETER MEASUREMENT INFORMATION



**Figure 5. Channel 1 Overcurrent Response:
 Enabled Into Overcurrent Load**



**Figure 6. Channel 1 Overcurrent Response: an
 Overcurrent Load Plugged Into the Enabled Board**

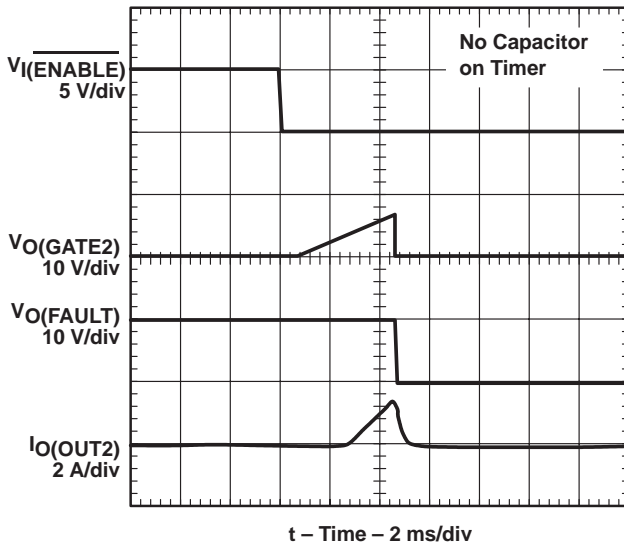

**Figure 7. Channel 2 Overcurrent Response:
 Enabled Into Overcurrent Load**

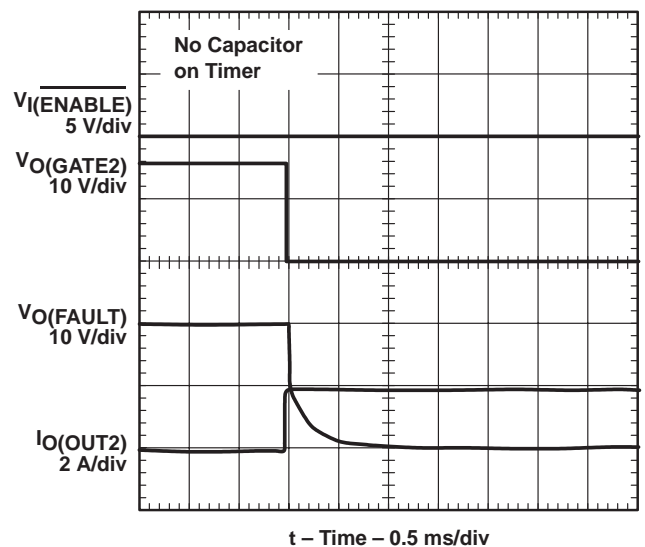
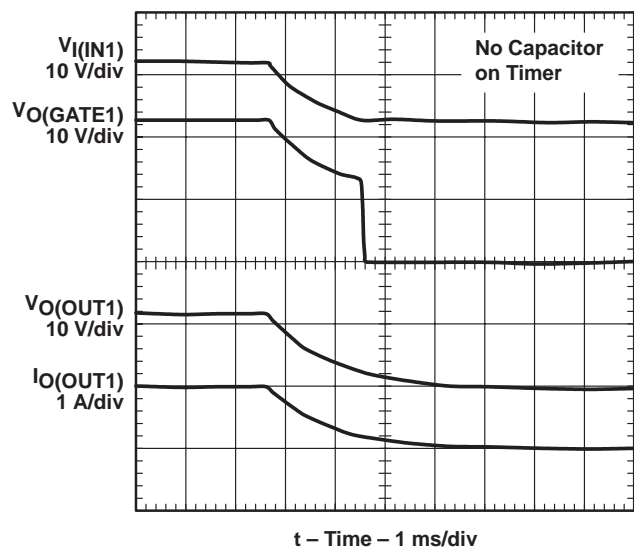
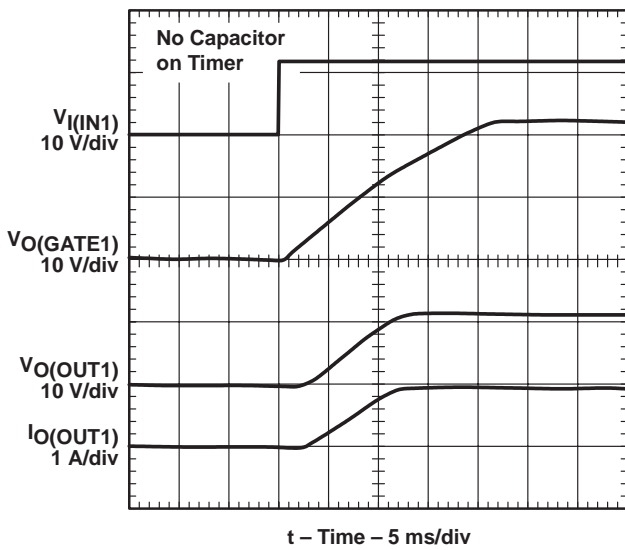
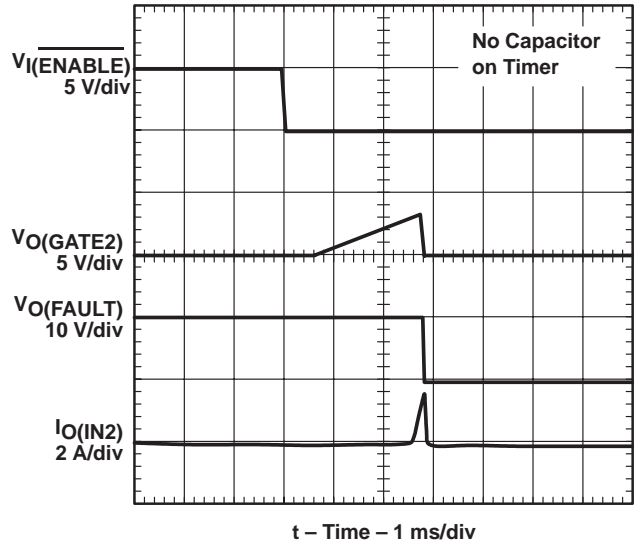
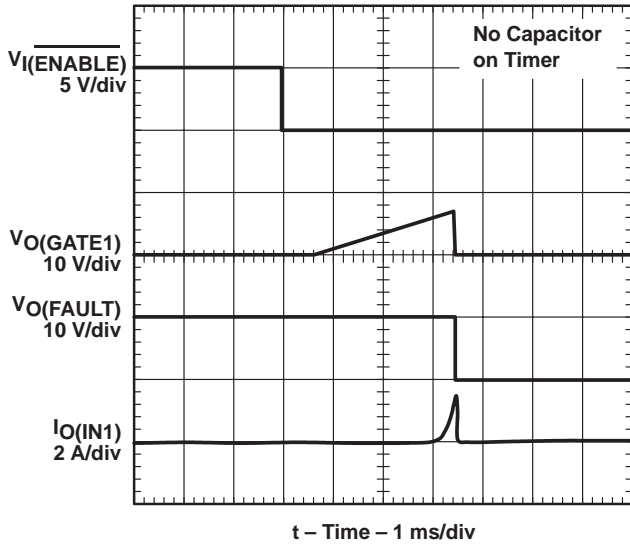

**Figure 8. Channel 2 Overcurrent Response: an
 Overcurrent Load Plugged Into the Enabled Board**

TPS2300, TPS2301
 DUAL HOT SWAP POWER CONTROLLER WITH INDEPENDENT
 CIRCUIT BREAKER AND POWER-GOOD REPORTING

SLVS265B – FEBRUARY 2000 – REVISED APRIL 2000

PARAMETER MEASUREMENT INFORMATION



PARAMETER MEASUREMENT INFORMATION

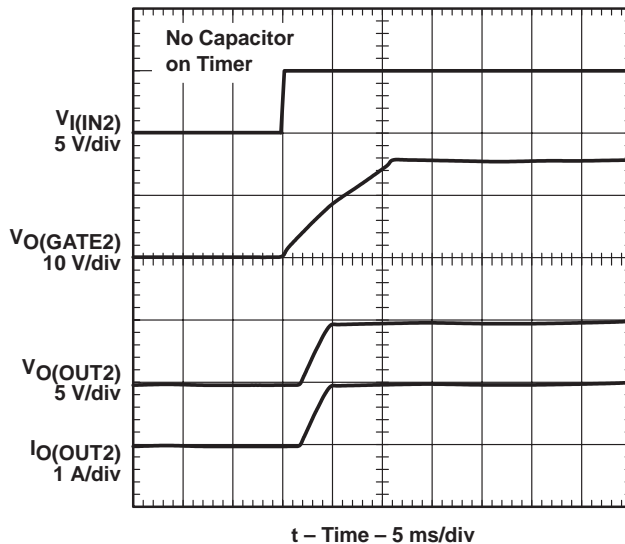

Figure 13. Channel 2 – Hot Plug

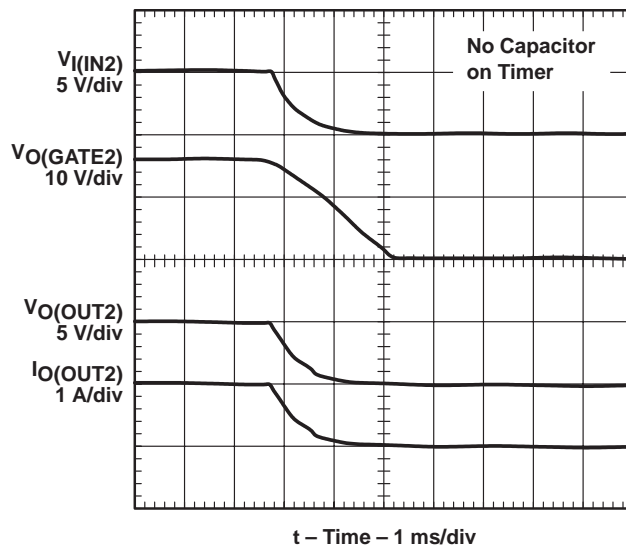

Figure 14. Channel 2 – Hot Removal

TPS2300, TPS2301
DUAL HOT SWAP POWER CONTROLLER WITH INDEPENDENT
CIRCUIT BREAKER AND POWER-GOOD REPORTING

SLVS265B – FEBRUARY 2000 – REVISED APRIL 2000

TYPICAL CHARACTERISTICS

SUPPLY CURRENT (ENABLED)
vs
VOLTAGE

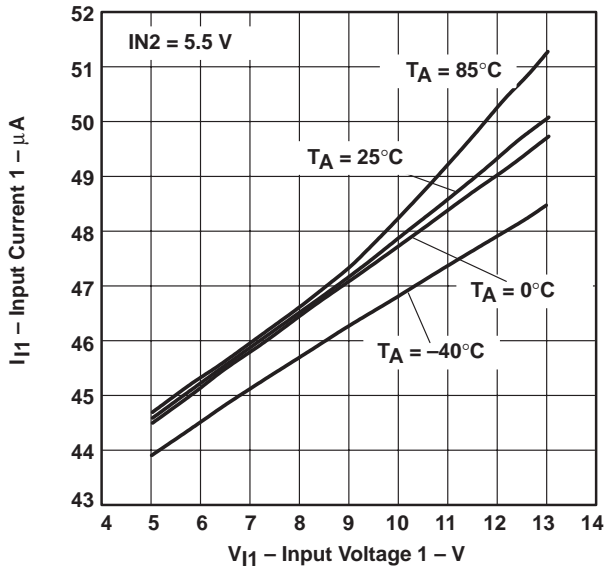

Figure 15

SUPPLY CURRENT (ENABLED)
vs
VOLTAGE

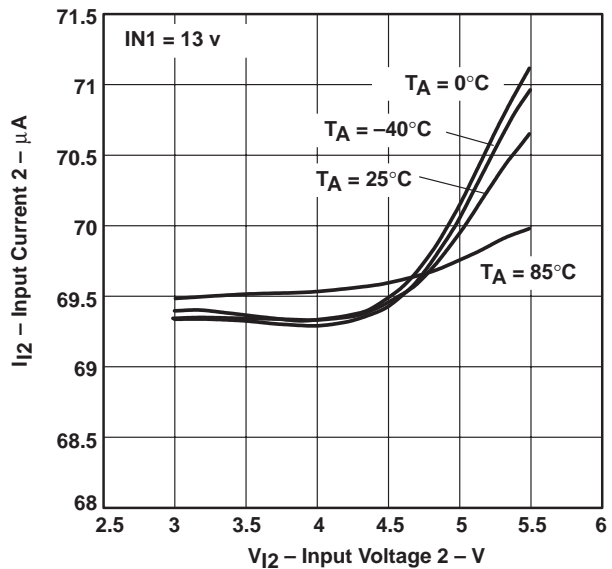

Figure 16

SUPPLY CURRENT (DISABLED)
vs
VOLTAGE

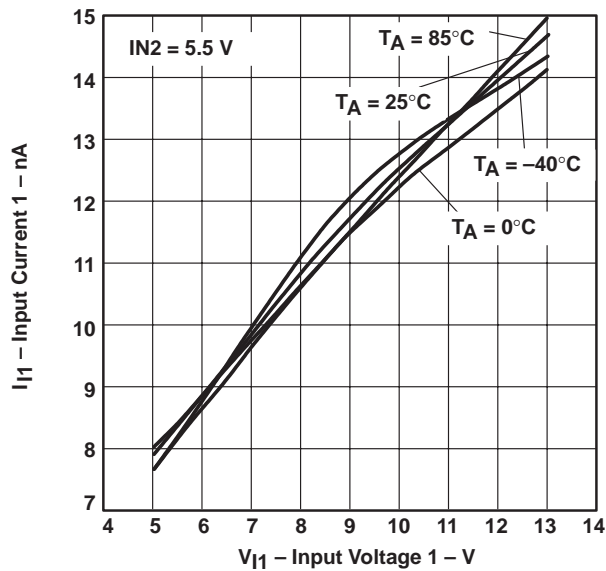

Figure 17

SUPPLY CURRENT (DISABLED)
vs
VOLTAGE

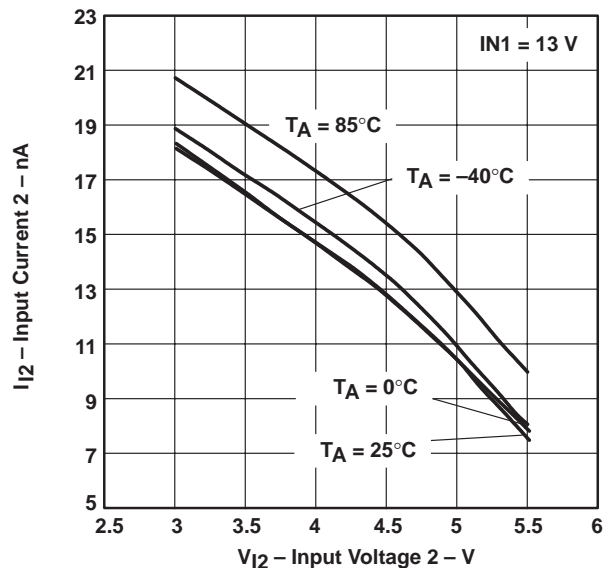
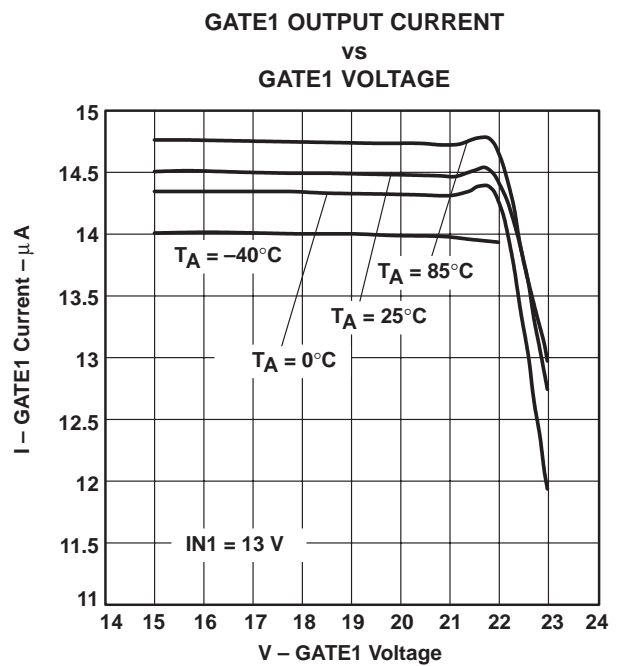
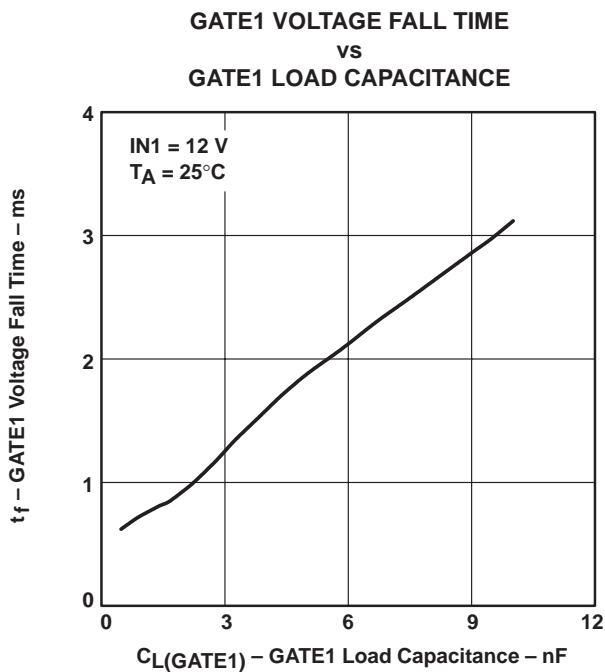
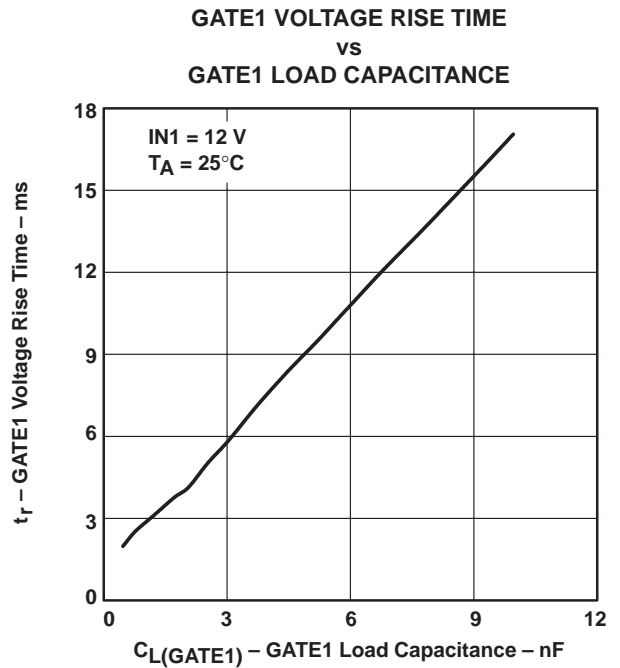
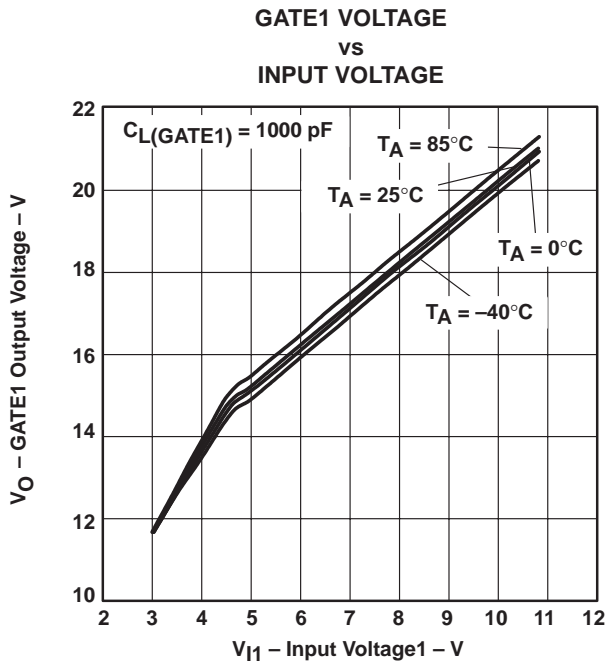

Figure 18

TYPICAL CHARACTERISTICS



TPS2300, TPS2301
DUAL HOT SWAP POWER CONTROLLER WITH INDEPENDENT
CIRCUIT BREAKER AND POWER-GOOD REPORTING

SLVS265B – FEBRUARY 2000 – REVISED APRIL 2000

TYPICAL CHARACTERISTICS

CIRCUIT BREAKER RESPONSE
vs
TIMER CAPACITANCE

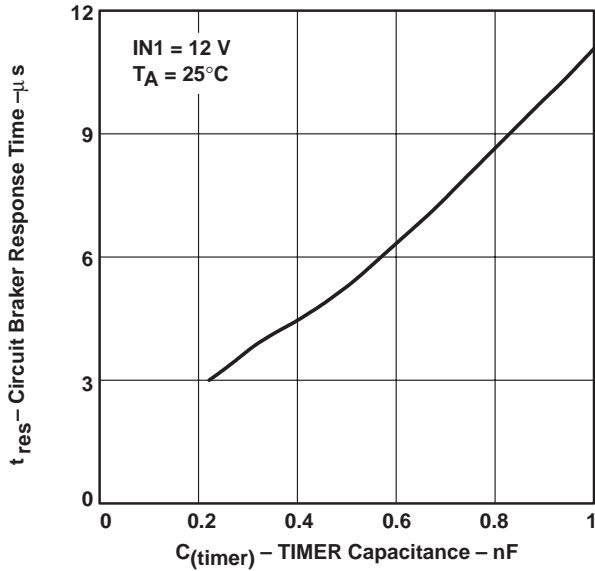

Figure 23

LOAD VOLTAGE 1 DISCHARGE TIME
vs
LOAD CAPACITANCE

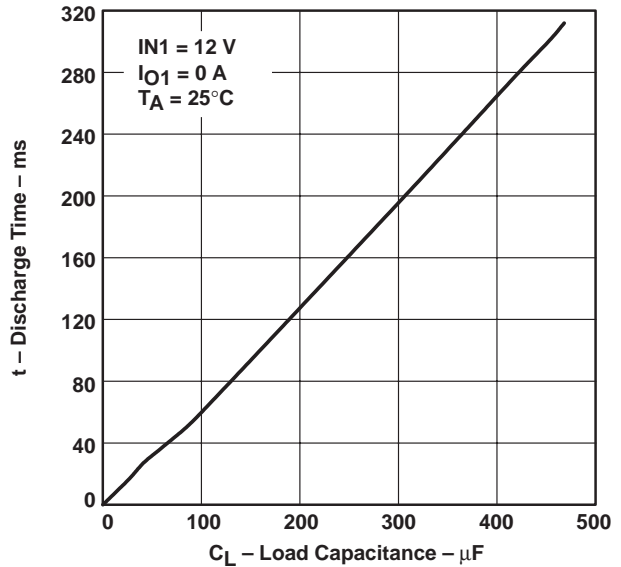

Figure 24

UVLO START AND STOP THRESHOLDS
vs
TEMPERATURE

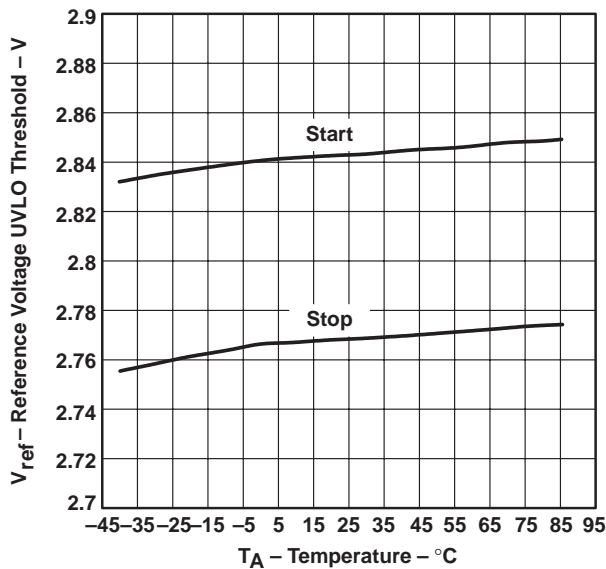

Figure 25

PWRGDx THRESHOLD
vs
TEMPERATURE

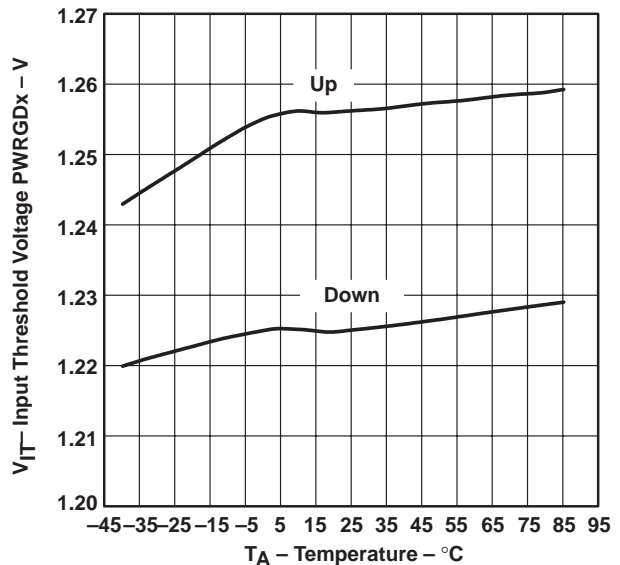

Figure 26



TPS2300, TPS2301 DUAL HOT SWAP POWER CONTROLLER WITH INDEPENDENT CIRCUIT BREAKER AND POWER-GOOD REPORTING

SLVS265B – FEBRUARY 2000 – REVISED APRIL 2000

APPLICATION INFORMATION

typical application diagram

This diagram shows a typical dual hot-swap application. The pullup resistors at PWRGD1, PWRGD2 and Fault should be relatively large (e.g. 100 k Ω) to reduce power loss unless they are required to drive a large load.

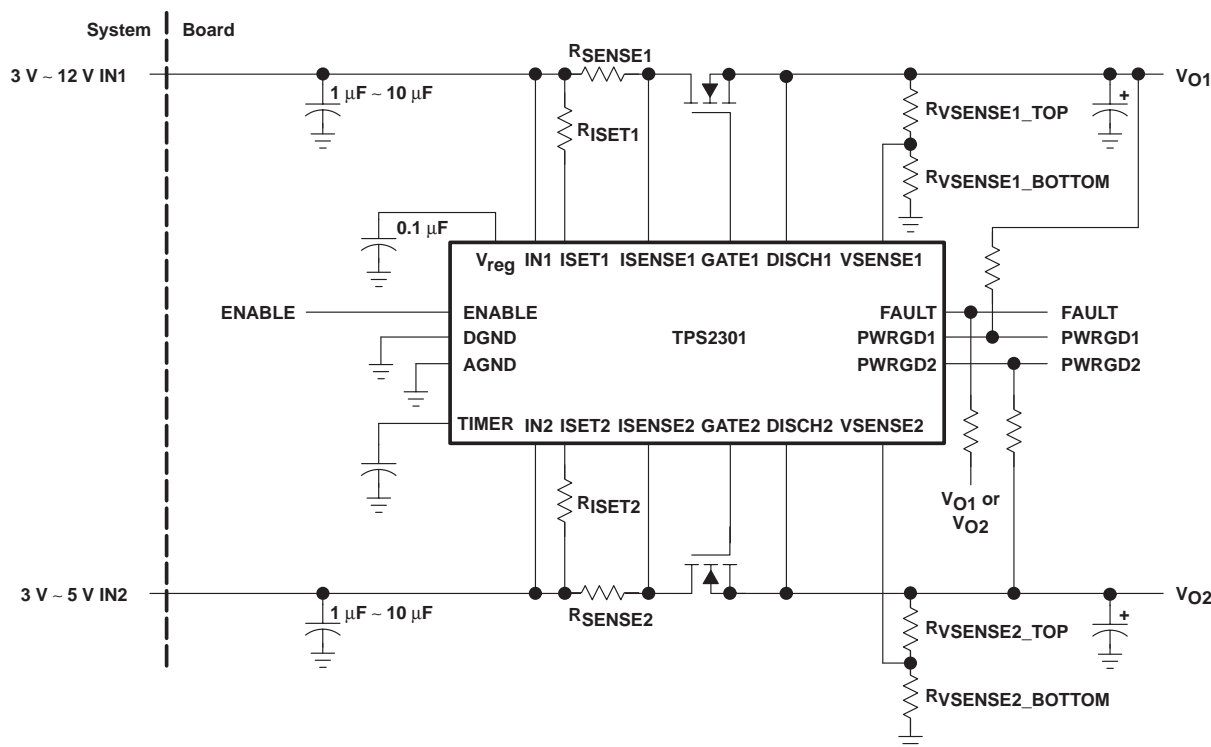

Figure 27. Typical Dual Hot-Swap Application

input capacitor

A 0.1- μ F ceramic capacitor in parallel with a 1- μ F ceramic capacitor should be placed on the input power terminals near the connector on the hot-plug board to help stabilize the voltage rails on the cards. The TPS2300/01 does not need to be mounted near the connector or these input capacitors. For applications with more severe power environments, a 2.2- μ F or higher ceramic capacitor is recommended near the input terminals of the hot-plug board. A bypass capacitor for IN1 and for IN2 should be placed close to the device.

output capacitor

A 0.1- μ F ceramic capacitor is recommended per load on the TPS2300/01; these capacitors should be placed close to the external FETs and to TPS2300/01. A larger bulk capacitor is also recommended on the load. The value of the bulk capacitor should be selected based on the power requirements and the transients generated by the application.

external FET

To deliver power from the input sources to the loads, each channel needs an external N-channel MOSFET. A few widely used MOSFETs are shown in Table 1. But many other MOSFETs in the market can also be used with TPS23xx in hot-swap systems.



TPS2300, TPS2301
DUAL HOT SWAP POWER CONTROLLER WITH INDEPENDENT
CIRCUIT BREAKER AND POWER-GOOD REPORTING

SLVS265B – FEBRUARY 2000 – REVISED APRIL 2000

APPLICATION INFORMATION

Table 1. Some Available N-Channel MOSFETs

CURRENT RANGE (A)	PART NUMBER	DESCRIPTION	MANUFACTURER
0 to 2	IRF7601	N-channel, $r_{DS(on)} = 0.035 \Omega$, 4.6 A, Micro-8	International Rectifier
	MTSF3N03HDR2	N-channel, $r_{DS(on)} = 0.040 \Omega$, 4.6 A, Micro-8	ON Semiconductor
	IRF7101	Dual N-channel, $r_{DS(on)} = 0.1 \Omega$, 2.3 A, SO-8	International Rectifier
	MMSF5N02HDR2	Dual N-channel, $r_{DS(on)} = 0.04 \Omega$, 5 A, SO-8	ON Semiconductor
2 to 5	IRF7401	N-channel, $r_{DS(on)} = 0.022 \Omega$, 7 A, SO-8	International Rectifier
	MMSF5N02HDR2	N-channel, $r_{DS(on)} = 0.025 \Omega$, 5 A, SO-8	ON Semiconductor
	IRF7313	Dual N-channel, $r_{DS(on)} = 0.029 \Omega$, 5.2 A, SO-8	International Rectifier
	SI4410	N-channel, $r_{DS(on)} = 0.020 \Omega$, 8 A, SO-8	Vishay Dale
5 to 10	IRLR3103	N-channel, $r_{DS(on)} = 0.019 \Omega$, 29 A, d-Pak	International Rectifier
	IRLR2703	N-channel, $r_{DS(on)} = 0.045 \Omega$, 14 A, d-Pak	International Rectifier

timer

For most applications, a minimum capacitance of 50 pF is recommended to prevent false triggering. This capacitor should be connected between TIMER and ground. The presence of an overcurrent condition on either channel of the TPS2300/01 causes a 50- μ A current source to begin charging this capacitor. If the overcurrent condition persists until the capacitor has been charged to approximately 0.5 V, the TPS2300/01 will latch off the offending channels and will pull the FAULT pin low. The timer capacitor can be made as large as desired to provide additional time delay before registering a fault condition.

output-voltage slew-rate control

When enabled, the TPS2300/01 controllers supply the gates of each external MOSFET transistor with a current of approximately 15 μ A. The slew rate of the MOSFET source voltage is thus limited by the gate-to-drain capacitance C_{gd} of the external MOSFET capacitor to a value approximating:

$$\frac{dvs}{dt} = \frac{15 \mu A}{C_{gd}}$$

If a slower slew rate is desired, an additional capacitance can be connected between the gate of the external MOSFET and ground.

VREG capacitor

The internal voltage regulator connected to VREG requires an external capacitor to ensure stability. A 0.1- μ F or 0.22- μ F ceramic capacitor is recommended.



APPLICATION INFORMATION

gate drive circuitry

The TPS2300/01 includes four separate features associated with each gate-drive terminal:

- A charging current of approximately 15 μA is applied to enable the external MOSFET transistor. This current is generated by an internal charge pump that can develop a gate-to-source potential (referenced to DISCH1 or DISCH2) of 9 V–12 V. DISCH1 and DISCH2 must be connected to the respective external MOSFET source terminals to ensure proper operation of this circuitry.
- A discharge current of approximately 75 μA is applied to disable the external MOSFET transistor. Once the transistor gate voltage has dropped below approximately 1.5 V, this current is disabled and the UVLO discharge driver is enabled instead. This feature allows the part to enter a low-current shutdown mode while ensuring that the gates of the external MOSFET transistors remain at a low voltage.
- During a UVLO condition, the gates of both MOSFET transistors are pulled down by internal PMOS transistors. These transistors continue to operate even if IN1 and IN2 are both at 0 V. This circuitry also helps hold the external MOSFET transistors off when power is suddenly applied to the system.
- During an overcurrent fault condition, the external MOSFET transistor that exhibited an over-current condition will be rapidly turned off by an internal pulldown circuit capable of pulling in excess of 400 mA (at 4 V) from the pin. Once the gate has been pulled below approximately 1.5 V, this driver is disengaged and the UVLO driver is enabled instead. If one channel experiences an overcurrent condition and the other does not, then only the channel that is conducting excessive current will be turned off rapidly. The other channel will continue to operate normally.

setting the current-limit circuit-breaker threshold

Using channel one as an example, the current sensing resistor R_{ISENSE1} and the current limit setting resistor R_{ISET1} determine the current limit of the channel, and can be calculated by the following equation:

$$I_{\text{LMT1}} = \frac{R_{\text{ISET1}} \times 50 \times 10^{-6}}{R_{\text{ISENSE1}}}$$

Typically R_{ISENSE1} is usually very small (0.001 Ω to 0.1 Ω). If the trace and solder-junction resistances between the junction of R_{ISENSE1} and ISENSE1 and the junction of R_{ISENSE1} and R_{ISET1} are greater than 10% of the R_{ISENSE1} value, then these resistance values should be added to the R_{ISENSE1} value used in the calculation above.

The above information and calculation also apply to channel 2. Table 2 shows some of the current sense resistors available in the market.

Table 2. Some Current Sense Resistors

CURRENT RANGE (A)	PART NUMBER	DESCRIPTION	MANUFACTURER
0 to 1	WSL-1206, 0.05 1%	0.05 Ω , 0.25 W, 1% resistor	Vishay Dale
1 to 2	WSL-1206, 0.025 1%	0.025 Ω , 0.25 W, 1% resistor	
2 to 4	WSL-1206, 0.015 1%	0.015 Ω , 0.25 W, 1% resistor	
4 to 6	WSL-2010, 0.010 1%	0.010 Ω , 0.5 W, 1% resistor	
6 to 8	WSL-2010, 0.007 1%	0.007 Ω , 0.5 W, 1% resistor	
8 to 10	WSR-2, 0.005 1%	0.005 Ω , 0.5 W, 1% resistor	

TPS2300, TPS2301

DUAL HOT SWAP POWER CONTROLLER WITH INDEPENDENT CIRCUIT BREAKER AND POWER-GOOD REPORTING

SLVS265B – FEBRUARY 2000 – REVISED APRIL 2000

APPLICATION INFORMATION

setting the power good threshold voltage

The two feedback resistors $R_{VSENSEx_TOP}$ and $R_{VSENSEx_BOT}$ connected between V_{Ox} and ground form a resistor divider setting the voltage at the $VSENSEx$ pins. $VSENSE1$ voltage equals to

$$V_{I(SENSE1)} = V_O \times R_{VSENSE1_BOT} / (R_{VSENSE1_TOP} + R_{VSENSE1_BOT})$$

This voltage is compared to an internal voltage reference ($1.225\text{ V} \pm 2\%$) to determine whether the output voltage level is within a specified tolerance. For example, given a nominal output voltage at V_{O1} , and defining V_{O1_min} as the minimum required output voltage, then the feedback resistors are defined by:

$$R_{VSENSE1_TOP} = \frac{V_{O1_min} - 1.225}{1.225} \times R_{VSENSE1_BOT}$$

Start the process by selecting a large standard resistor value for $R_{VSENSE1_BOT}$ to reduce power loss. Then $R_{VSENSE1_TOP}$ can be calculated by inserting all of the known values into the equation above. When V_{O1} is lower than V_{O1_min} , $PWRGD1$ will be low as long as the controller is enabled.

undervoltage lockout (UVLO)

The TPS2300/01 includes an undervoltage lockout (UVLO) feature that monitors the voltage present on the $VREG$ pin. This feature will disable both external MOSFETs if the voltage on $VREG$ drops below 2.78 V (nominal) and will re-enable normal operation when it rises above 2.85 V (nominal). Since $VREG$ is fed from $IN1$ through a low-dropout voltage regulator, the voltage on $VREG$ will track the voltage on $IN1$ within 50 mV. While the undervoltage lockout is engaged, both $GATE1$ and $GATE2$ are held low by internal PMOS pulldown transistors, ensuring that the external MOSFET transistors remain off at all times, even if all power supplies have fallen to 0 V.

single-channel operation

Some applications may require only a single external MOS transistor. Such applications should use $GATE1$ and the associated circuitry ($IN1$, $ISENSE1$, $ISSET1$, $DISCH1$). The $IN2$ pin should be grounded to disable the circuitry associated with the $GATE2$ pin. The $VSENSE2$ and $PWRGD2$ circuitry is unaffected by disabling $GATE2$, and may still be used if so desired.

power-up control

The TPS2300/01 includes a 500 μs (nominal) startup delay that ensures that internal circuitry has sufficient time to start before the device begins turning on the external MOSFETs. This delay is triggered only upon the rapid application of power to the circuit. If the power supply ramps up slowly, the undervoltage lockout circuitry will provide adequate protection against undervoltage operation.

3-channel hot-swap application

Some applications require hot-swap control of up to three voltage rails, but may not explicitly require the sensing of the status of the output power on all three of the voltage rails. One such application is device bay, where dv/dt control of 3.3 V, 5 V, and 12 V is required. By using channel 2 to drive both the 3.3-V and 5-V power rails and channel 1 to drive the 12-V power rail, as is shown below, TPS2300/01 can deliver three different voltages to three loads while monitoring the status of two of the loads.



TPS2300, TPS2301
**DUAL HOT SWAP POWER CONTROLLER WITH INDEPENDENT
 CIRCUIT BREAKER AND POWER-GOOD REPORTING**

SLVS265B – FEBRUARY 2000 – REVISED APRIL 2000

APPLICATION INFORMATION

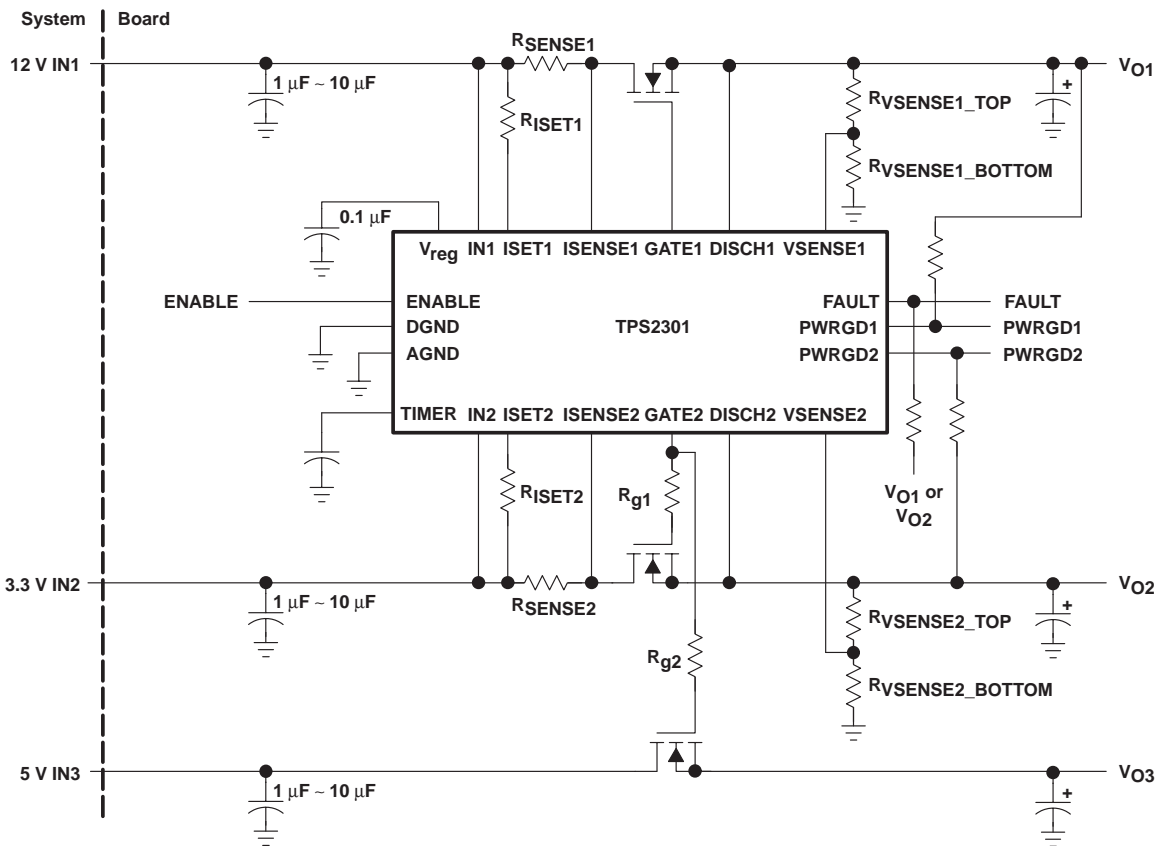

Figure 28. Three-Channel Application

APPLICATION INFORMATION

Figure 29 shows ramp-up waveforms of the three output voltages.

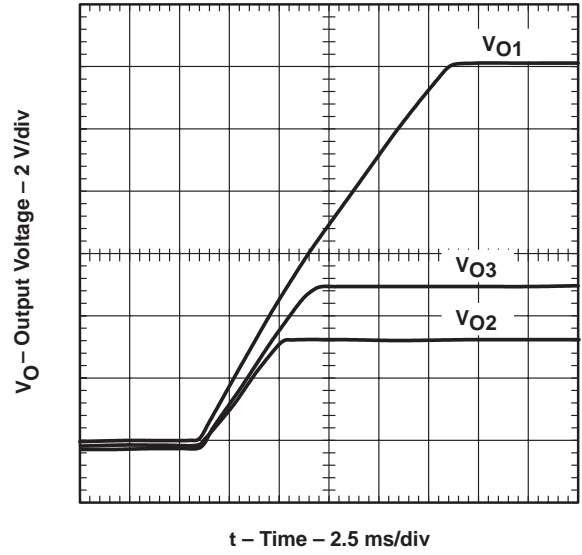

Figure 29

TPS2300, TPS2301
**DUAL HOT SWAP POWER CONTROLLER WITH INDEPENDENT
 CIRCUIT BREAKER AND POWER-GOOD REPORTING**

SLVS265B – FEBRUARY 2000 – REVISED APRIL 2000

MECHANICAL DATA

PW (R-PDSO-G)**

PLASTIC SMALL-OUTLINE PACKAGE

14 PINS SHOWN

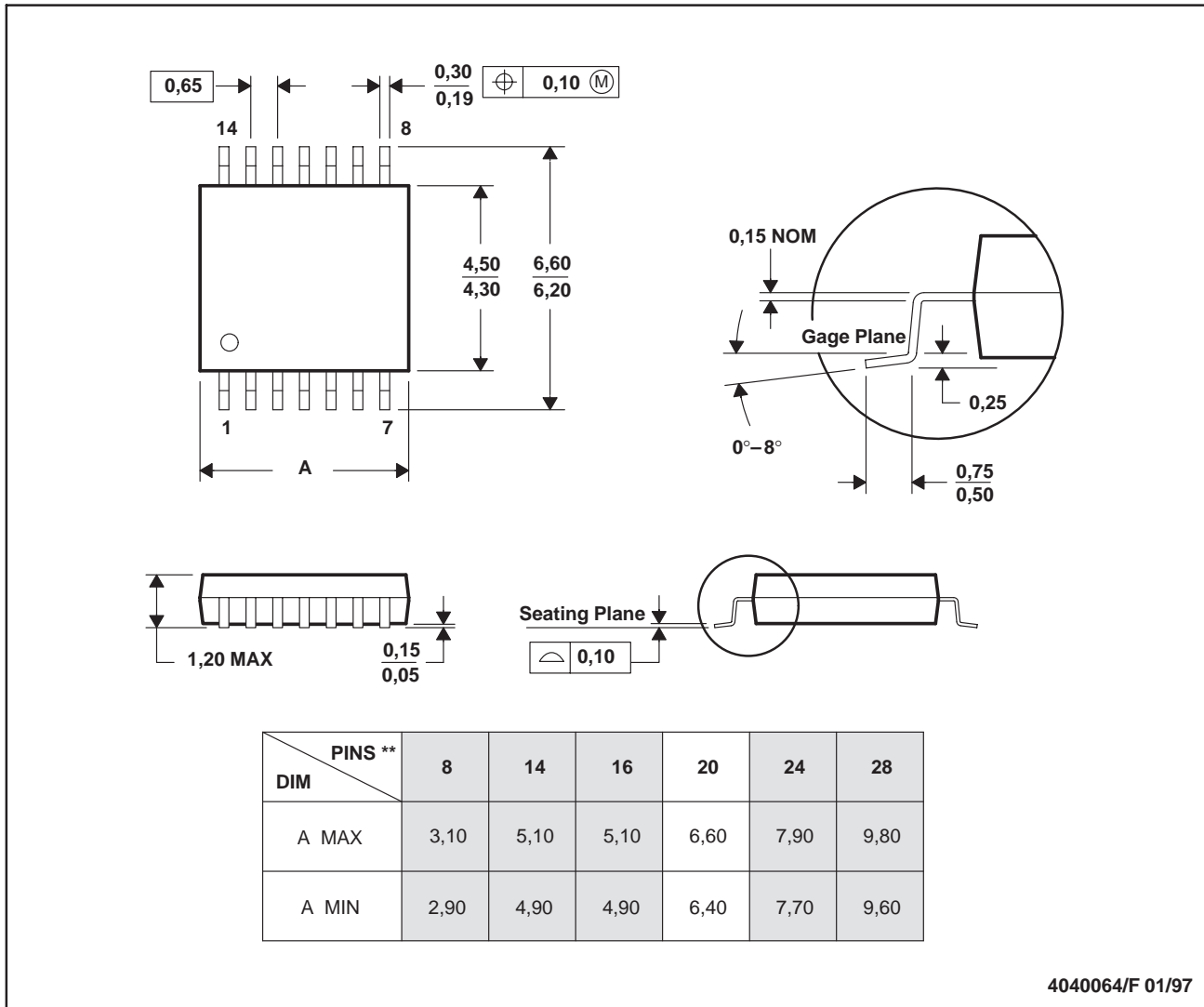

4040064/F 01/97

- NOTES: A. All linear dimensions are in millimeters.
 B. This drawing is subject to change without notice.
 C. Body dimensions do not include mold flash or protrusion not to exceed 0,15.
 D. Falls within JEDEC MO-153



POST OFFICE BOX 655303 • DALLAS, TEXAS 75265

IMPORTANT NOTICE

Texas Instruments and its subsidiaries (TI) reserve the right to make changes to their products or to discontinue any product or service without notice, and advise customers to obtain the latest version of relevant information to verify, before placing orders, that information being relied on is current and complete. All products are sold subject to the terms and conditions of sale supplied at the time of order acknowledgment, including those pertaining to warranty, patent infringement, and limitation of liability.

TI warrants performance of its semiconductor products to the specifications applicable at the time of sale in accordance with TI's standard warranty. Testing and other quality control techniques are utilized to the extent TI deems necessary to support this warranty. Specific testing of all parameters of each device is not necessarily performed, except those mandated by government requirements.

Customers are responsible for their applications using TI components.

In order to minimize risks associated with the customer's applications, adequate design and operating safeguards must be provided by the customer to minimize inherent or procedural hazards.

TI assumes no liability for applications assistance or customer product design. TI does not warrant or represent that any license, either express or implied, is granted under any patent right, copyright, mask work right, or other intellectual property right of TI covering or relating to any combination, machine, or process in which such semiconductor products or services might be or are used. TI's publication of information regarding any third party's products or services does not constitute TI's approval, warranty or endorsement thereof.