

# TPS2010A, TPS2011A, TPS2012A, TPS2013A POWER-DISTRIBUTION SWITCHES

SLVS189A – DECEMBER 1998 – REVISED NOVEMBER 1999

- **33-mΩ (5-V Input) High-Side MOSFET Switch**
- **Short-Circuit and Thermal Protection**
- **Operating Range . . . 2.7 V to 5.5 V**
- **Logic-Level Enable Input**
- **Typical Rise Time . . . 6.1 ms**
- **Undervoltage Lockout**
- **Maximum Standby Supply Current . . . 10 μA**
- **No Drain-Source Back-Gate Diode**
- **Available in 8-pin SOIC and 14-Pin TSSOP Packages**
- **Ambient Temperature Range, –40°C to 85°C**
- **2-kV Human-Body-Model, 200-V Machine-Model ESD Protection**

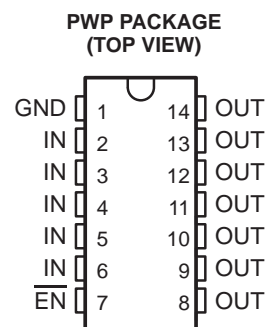
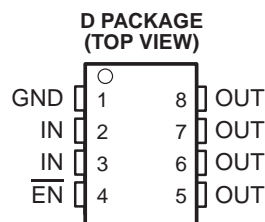

## description

The TPS201xA family of power distribution switches is intended for applications where heavy capacitive loads and short circuits are likely to be encountered. These devices are 50-mΩ N-channel MOSFET high-side power switches. The switch is controlled by a logic enable compatible with 5-V logic and 3-V logic. Gate drive is provided by an internal charge pump designed to control the power-switch rise times and fall times to minimize current surges during switching. The charge pump requires no external components and allows operation from supplies as low as 2.7 V.

When the output load exceeds the current-limit threshold or a short is present, the TPS201xA limits the output current to a safe level by switching into a constant-current mode. When continuous heavy overloads and short circuits increase the power dissipation in the switch, causing the junction temperature to rise, a thermal protection circuit shuts off the switch to prevent damage. Recovery from a thermal shutdown is automatic once the device has cooled sufficiently. Internal circuitry ensures the switch remains off until valid input voltage is present.

The TPS201xA devices differ only in short-circuit current threshold. The TPS2010A limits at 0.3-A load, the TPS2011 at 0.9-A load, the TPS2012A at 1.5-A load, and the TPS2013A at 2.2-A load (see Available Options). The TPS201xA is available in an 8-pin small-outline integrated-circuit (SOIC) package and in a 14-pin thin-shrink small-outline package (TSSOP) and operates over a junction temperature range of –40°C to 125°C.

GENERAL SWITCH CATALOG			
<b>33 mΩ, single</b>  TPS201xA 0.2 A – 2 A TPS202x 0.2 A – 2 A TPS203x 0.2 A – 2 A	<b>80 mΩ, dual</b>  TPS2042 500 mA TPS2052 500 mA TPS2046 250 mA TPS2056 250 mA	<b>80 mΩ, triple</b>  TPS2043 500 mA TPS2053 500 mA TPS2047 250 mA TPS2057 250 mA	<b>80 mΩ, quad</b>  TPS2044 500 mA TPS2054 500 mA TPS2048 250 mA TPS2058 250 mA
<b>80 mΩ, single</b>  TPS2014 600 mA TPS2015 1 A TPS2041 500 mA TPS2051 500 mA TPS2045 250 mA TPS2055 250 mA	<b>260 mΩ</b>  TPS2100/1 IN1 500 mA IN2 10 mA TPS2102/3/4/5 IN1 500 mA IN2 100 mA		



Please be aware that an important notice concerning availability, standard warranty, and use in critical applications of Texas Instruments semiconductor products and disclaimers thereto appears at the end of this data sheet.

PRODUCTION DATA information is current as of publication date. Products conform to specifications per the terms of Texas Instruments standard warranty. Production processing does not necessarily include testing of all parameters.

**TEXAS  
INSTRUMENTS**

POST OFFICE BOX 655303 • DALLAS, TEXAS 75265

Copyright © 1998, Texas Instruments Incorporated

# TPS2010A, TPS2011A, TPS2012A, TPS2013A POWER-DISTRIBUTION SWITCHES

SLVS189A – DECEMBER 1998 – REVISED NOVEMBER 1999

## AVAILABLE OPTIONS

T <sub>A</sub>	ENABLE	RECOMMENDED MAXIMUM CONTINUOUS LOAD CURRENT (A)	TYPICAL SHORT-CIRCUIT CURRENT LIMIT AT 25°C (A)	PACKAGED DEVICES	
				SMALL OUTLINE (D) <sup>†</sup>	TSSOP (PWP) <sup>‡</sup>
-40°C to 85°C	Active low	0.2	0.3	TPS2010AD	TPS2010APWPR
		0.6	0.9	TPS2011AD	TPS2011APWPR
		1	1.5	TPS2012AD	TPS2012APWPR
		1.5	2.2	TPS2013AD	TPS2013APWPR

<sup>†</sup> The D package is available taped and reeled. Add an R suffix to device type (e.g., TPS2010DR)

<sup>‡</sup> The PWP package is only available left-end taped-and-reeled.

## TPS201xA functional block diagram

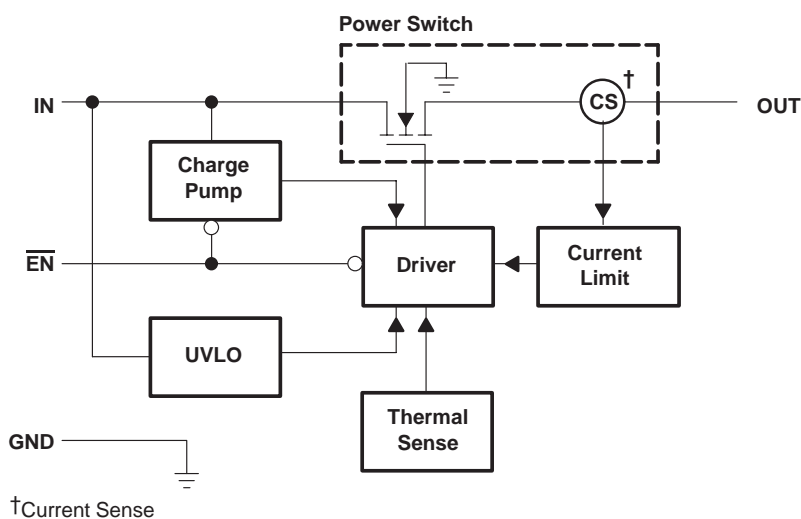

## Terminal Functions

TERMINAL			I/O	DESCRIPTION
NAME	NO. D	NO. PWP		
$\overline{\text{EN}}$	4	7	I	Enable input. Logic low turns on power switch.
GND	1	1	I	Ground
IN	2, 3	2-6	I	Input voltage
OUT	5, 6, 7, 8	8-14	O	Power-switch output



POST OFFICE BOX 655303 • DALLAS, TEXAS 75265

## detailed description

### power switch

The power switch is an N-channel MOSFET with a maximum on-state resistance of 50 m $\Omega$  ( $V_{I(IN)} = 5$  V). Configured as a high-side switch, the power switch prevents current flow from OUT to IN and IN to OUT when disabled.

### charge pump

An internal charge pump supplies power to the driver circuit and provides the necessary voltage to pull the gate of the MOSFET above the source. The charge pump operates from input voltages as low as 2.7 V and requires very little supply current.

### driver

The driver controls the gate voltage of the power switch. To limit large current surges and reduce the associated electromagnetic interference (EMI) produced, the driver incorporates circuitry that controls the rise times and fall times of the output voltage. The rise and fall times are typically in the 2-ms to 9-ms range.

### enable ( $\overline{EN}$ )

The logic enable disables the power switch, the bias for the charge pump, driver, and other circuitry to reduce the supply current to less than 10  $\mu$ A when a logic high is present on  $\overline{EN}$ . A logic zero input on  $\overline{EN}$  restores bias to the drive and control circuits and turns the power on. The enable input is compatible with both TTL and CMOS logic levels.

### current sense

A sense FET monitors the current supplied to the load. The sense FET measures current more efficiently than conventional resistance methods. When an overload or short circuit is encountered, the current-sense circuitry sends a control signal to the driver. The driver, in turn, reduces the gate voltage and drives the power FET into its saturation region, which switches the output into a constant current mode and holds the current constant while varying the voltage on the load.

### thermal sense

An internal thermal-sense circuit shuts off the power switch when the junction temperature rises to approximately 140°C. Hysteresis is built into the thermal sense circuit. After the device has cooled approximately 20°C, the switch turns back on. The switch continues to cycle off and on until the fault is removed.

### undervoltage lockout

A voltage sense circuit monitors the input voltage. When the input voltage is below approximately 2 V, a control signal turns off the power switch.

# TPS2010A, TPS2011A, TPS2012A, TPS2013A POWER-DISTRIBUTION SWITCHES

SLVS189A – DECEMBER 1998 – REVISED NOVEMBER 1999

## absolute maximum ratings over operating free-air temperature range (unless otherwise noted)†

Input voltage range, $V_{I(IN)}$ (see Note 1) .....	-0.3 V to 6 V
Output voltage range, $V_{O(OUT)}$ (see Note 1) .....	-0.3 V to $V_{I(IN)} + 0.3$ V
Input voltage range, $V_{I(EN)}$ .....	-0.3 V to 6 V
Continuous output current, $I_{O(OUT)}$ .....	internally limited
Continuous total power dissipation .....	See Dissipation Rating Table
Operating virtual junction temperature range, $T_J$ .....	-40°C to 125°C
Storage temperature range, $T_{stg}$ .....	-65°C to 150°C
Lead temperature soldering 1,6 mm (1/16 inch) from case for 10 seconds .....	260°C
Electrostatic discharge (ESD) protection: Human body model .....	2 kV
Machine model .....	200V

† Stresses beyond those listed under “absolute maximum ratings” may cause permanent damage to the device. These are stress ratings only, and functional operation of the device at these or any other conditions beyond those indicated under “recommended operating conditions” is not implied. Exposure to absolute-maximum-rated conditions for extended periods may affect device reliability.

NOTE 1: All voltages are with respect to GND.

DISSIPATION RATING TABLE

PACKAGE	$T_A \leq 25^\circ\text{C}$ POWER RATING	DERATING FACTOR ABOVE $T_A = 25^\circ\text{C}$	$T_A = 70^\circ\text{C}$ POWER RATING	$T_A = 85^\circ\text{C}$ POWER RATING
D	725 mW	5.8 mW/°C	464 mW	377 mW
PWP	700 mW	5.6 mW/°C	448 mW	364 mW

## recommended operating conditions

		MIN	MAX	UNIT
Input voltage	$V_{I(IN)}$	2.7	5.5	V
	$V_{I(EN)}$	0	5.5	V
Continuous output current, $I_O$	TPS2010A	0	0.2	A
	TPS2011A	0	0.6	
	TPS2012A	0	1	
	TPS2013A	0	1.5	
Operating virtual junction temperature, $T_J$		-40	125	°C



# TPS2010A, TPS2011A, TPS2012A, TPS2013A POWER-DISTRIBUTION SWITCHES

SLVS189A – DECEMBER 1998 – REVISED NOVEMBER 1999

electrical characteristics over recommended operating junction temperature range,  $V_{I(IN)} = 5.5\text{ V}$ ,  $I_O = \text{rated current}$ ,  $\overline{EN} = 0\text{ V}$  (unless otherwise noted)

## power switch

PARAMETER		TEST CONDITIONS†	MIN	TYP	MAX	UNIT
$r_{DS(on)}$	Static drain-source on-state resistance	$V_{I(IN)} = 5\text{ V}$ , $T_J = 25^\circ\text{C}$ , $I_O = 1.5\text{ A}$		33	36	m $\Omega$
		$V_{I(IN)} = 5\text{ V}$ , $T_J = 85^\circ\text{C}$ , $I_O = 1.5\text{ A}$		38	46	
		$V_{I(IN)} = 5\text{ V}$ , $T_J = 125^\circ\text{C}$ , $I_O = 1.5\text{ A}$		44	50	
		$V_{I(IN)} = 3.3\text{ V}$ , $T_J = 25^\circ\text{C}$ , $I_O = 1.5\text{ A}$		37	41	
		$V_{I(IN)} = 3.3\text{ V}$ , $T_J = 85^\circ\text{C}$ , $I_O = 1.5\text{ A}$		43	52	
		$V_{I(IN)} = 3.3\text{ V}$ , $T_J = 125^\circ\text{C}$ , $I_O = 1.5\text{ A}$		51	61	
		$V_{I(IN)} = 5\text{ V}$ , $T_J = 25^\circ\text{C}$ , $I_O = 0.18\text{ A}$		30	34	
		$V_{I(IN)} = 5\text{ V}$ , $T_J = 85^\circ\text{C}$ , $I_O = 0.18\text{ A}$		35	41	
		$V_{I(IN)} = 5\text{ V}$ , $T_J = 125^\circ\text{C}$ , $I_O = 0.18\text{ A}$		39	47	
		$V_{I(IN)} = 3.3\text{ V}$ , $T_J = 25^\circ\text{C}$ , $I_O = 0.18\text{ A}$		33	37	
		$V_{I(IN)} = 3.3\text{ V}$ , $T_J = 85^\circ\text{C}$ , $I_O = 0.18\text{ A}$		39	46	
		$V_{I(IN)} = 3.3\text{ V}$ , $T_J = 125^\circ\text{C}$ , $I_O = 0.18\text{ A}$		44	56	
$t_r$	Rise time, output	$V_{I(IN)} = 5.5\text{ V}$ , $T_J = 25^\circ\text{C}$ , $C_L = 1\ \mu\text{F}$ , $R_L = 10\ \Omega$		6.1		ms
		$V_{I(IN)} = 2.7\text{ V}$ , $T_J = 25^\circ\text{C}$ , $C_L = 1\ \mu\text{F}$ , $R_L = 10\ \Omega$		8.6		
$t_f$	Fall time, output	$V_{I(IN)} = 5.5\text{ V}$ , $T_J = 25^\circ\text{C}$ , $C_L = 1\ \mu\text{F}$ , $R_L = 10\ \Omega$		3.4		ms
		$V_{I(IN)} = 2.7\text{ V}$ , $T_J = 25^\circ\text{C}$ , $C_L = 1\ \mu\text{F}$ , $R_L = 10\ \Omega$		3		

† Pulse-testing techniques maintain junction temperature close to ambient temperature; thermal effects must be taken into account separately.

## enable input ( $\overline{EN}$ )

PARAMETER		TEST CONDITIONS	MIN	TYP	MAX	UNIT
$V_{IH}$	High-level input voltage	$2.7\text{ V} \leq V_{I(IN)} \leq 5.5\text{ V}$	2			V
$V_{IL}$	Low-level input voltage	$4.5\text{ V} \leq V_{I(IN)} \leq 5.5\text{ V}$			0.8	V
		$2.7\text{ V} \leq V_{I(IN)} \leq 4.5\text{ V}$			0.5	
$I_I$	Input current	$\overline{EN} = 0\text{ V}$ or $\overline{EN} = V_{I(IN)}$	-0.5		0.5	$\mu\text{A}$
$t_{on}$	Turnon time	$C_L = 100\ \mu\text{F}$ , $R_L = 10\ \Omega$			20	ms
$t_{off}$	Turnoff time	$C_L = 100\ \mu\text{F}$ , $R_L = 10\ \Omega$			40	

## current limit

PARAMETER		TEST CONDITIONS†	MIN	TYP	MAX	UNIT	
$I_{OS}$	Short-circuit output current	$T_J = 25^\circ\text{C}$ , $V_I = 5.5\text{ V}$ , OUT connected to GND, Device enable into short circuit	TPS2010A	0.22	0.3	0.4	A
			TPS2011A	0.66	0.9	1.1	
			TPS2012A	1.1	1.5	1.8	
			TPS2013A	1.65	2.2	2.7	

† Pulse-testing techniques maintain junction temperature close to ambient temperature; thermal effects must be taken into account separately.



# TPS2010A, TPS2011A, TPS2012A, TPS2013A POWER-DISTRIBUTION SWITCHES

SLVS189A – DECEMBER 1998 – REVISED NOVEMBER 1999

electrical characteristics over recommended operating junction temperature range,  $V_{I(IN)} = 5.5\text{ V}$ ,  $I_O = \text{rated current}$ ,  $\overline{EN} = 0\text{ V}$  (unless otherwise noted) (continued)

## supply current

PARAMETER	TEST CONDITIONS			MIN	TYP	MAX	UNIT
Supply current, low-level output	No Load on OUT	$\overline{EN} = V_{I(IN)}$	$T_J = 25^\circ\text{C}$	0.3	1		$\mu\text{A}$
			$-40^\circ\text{C} \leq T_J \leq 125^\circ\text{C}$			10	
Supply current, high-level output	No Load on OUT	$\overline{EN} = 0\text{ V}$	$T_J = 25^\circ\text{C}$	58	75		$\mu\text{A}$
			$-40^\circ\text{C} \leq T_J \leq 125^\circ\text{C}$	75	100		
Leakage current	OUT connected to ground	$\overline{EN} = V_{I(IN)}$	$-40^\circ\text{C} \leq T_J \leq 125^\circ\text{C}$	10			$\mu\text{A}$

## undervoltage lockout

PARAMETER	TEST CONDITIONS	MIN	TYP	MAX	UNIT
Low-level input voltage		2		2.5	V
Hysteresis	$T_J = 25^\circ\text{C}$		100		mV



PARAMETER MEASUREMENT INFORMATION

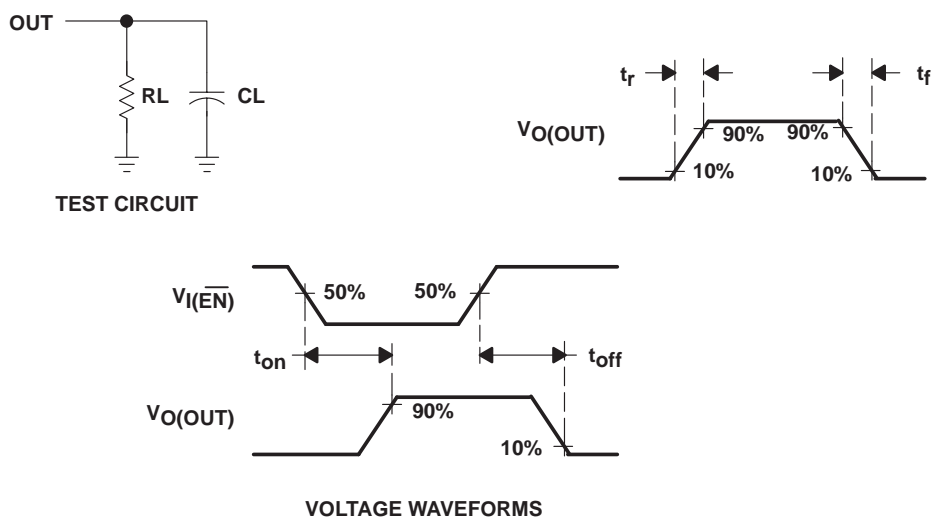

Figure 1. Test Circuit and Voltage Waveforms

Table of Timing Diagrams

	FIGURE
Turnon Delay and Rise Time	2
Turnoff Delay and Fall Time	3
Turnon Delay and Rise Time with 1- $\mu$ F Load	4
Turnoff Delay and Rise Time with 1- $\mu$ F Load	5
Device Enabled into Short	6
TPS2010A, TPS2011A, TPS2012A, and TPS2013A, Ramped Load on Enabled Device	7, 8, 9, 10
TPS2013A, Inrush Current	11
7.9- $\Omega$ Load Connected to an Enabled TPS2010A Device	12
3.7- $\Omega$ Load Connected to an Enabled TPS2010A Device	13
3.7- $\Omega$ Load Connected to an Enabled TPS2011A Device	14
2.6- $\Omega$ Load Connected to an Enabled TPS2011A Device	15
2.6- $\Omega$ Load Connected to an Enabled TPS2012A Device	16
1.2- $\Omega$ Load Connected to an Enabled TPS2012A Device	17
1.2- $\Omega$ Load Connected to an Enabled TPS2013A Device	18
0.9- $\Omega$ Load Connected to an Enabled TPS2013A Device	19

# TPS2010A, TPS2011A, TPS2012A, TPS2013A POWER-DISTRIBUTION SWITCHES

SLVS189A – DECEMBER 1998 – REVISED NOVEMBER 1999

## PARAMETER MEASUREMENT INFORMATION

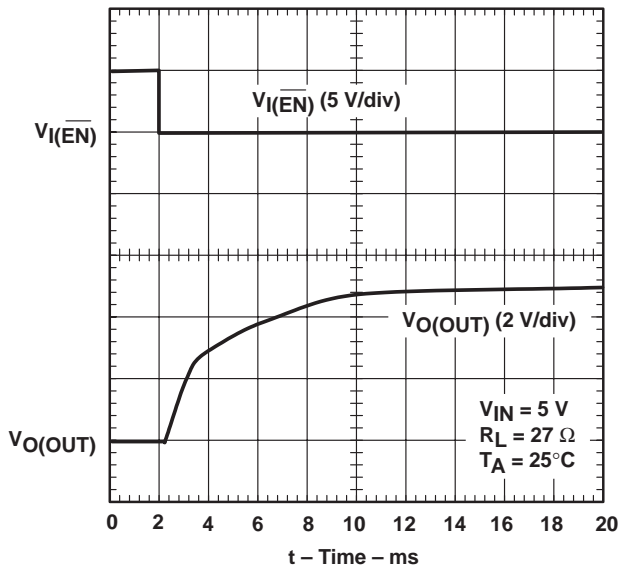

Figure 2. Turnon Delay and Rise Time

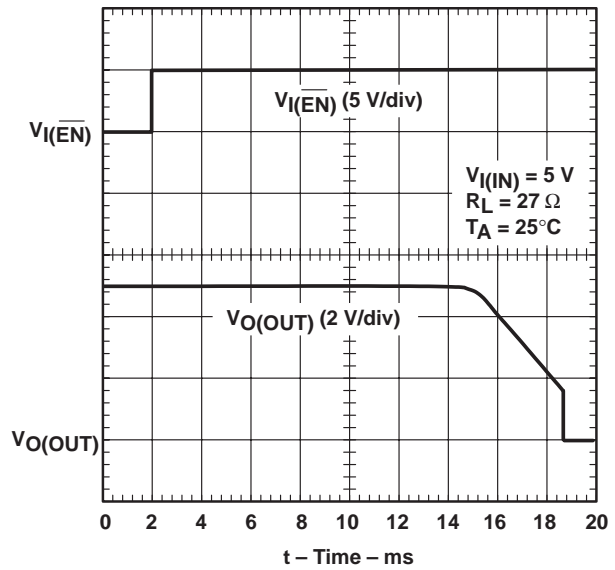

Figure 3. Turnoff Delay and Fall Time

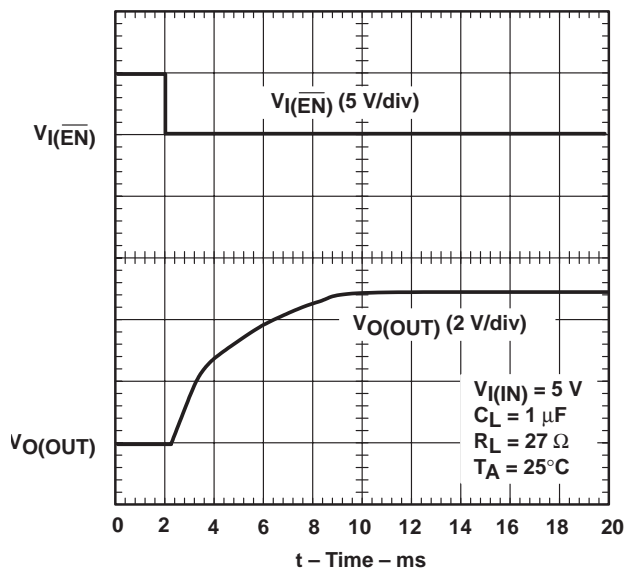

Figure 4. Turnon Delay and Rise Time  
With 1- $\mu\text{F}$  Load

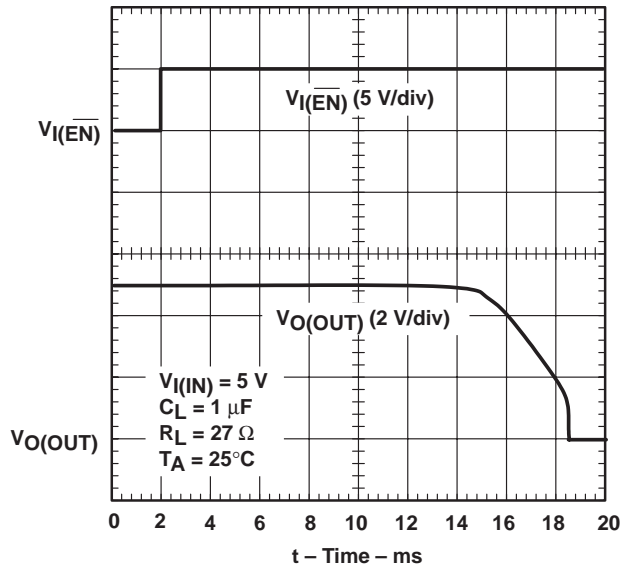

Figure 5. Turnoff Delay and Fall Time  
With 1- $\mu\text{F}$  Load



PARAMETER MEASUREMENT INFORMATION

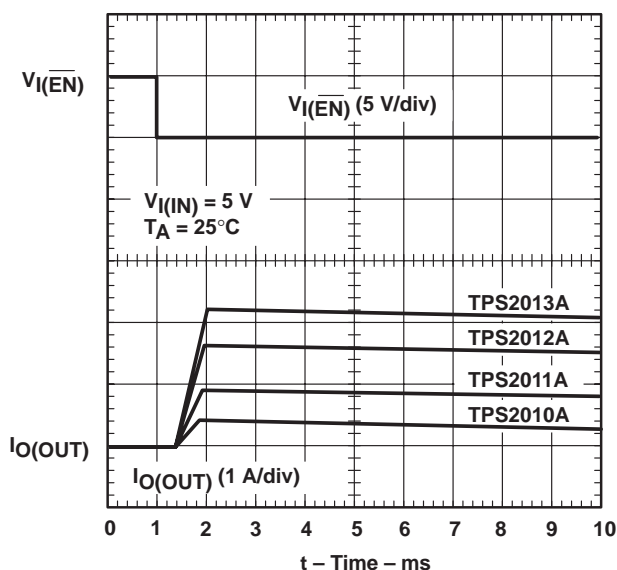

Figure 6. Device Enabled Into Short

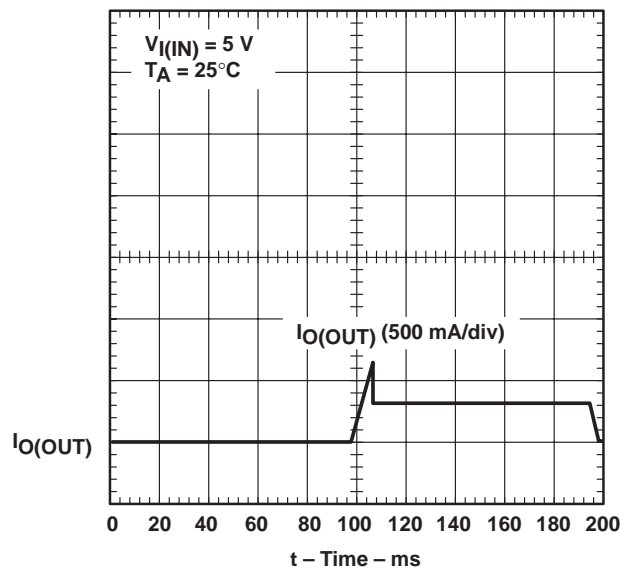

Figure 7. TPS2010A, Ramped Load on Enabled Device

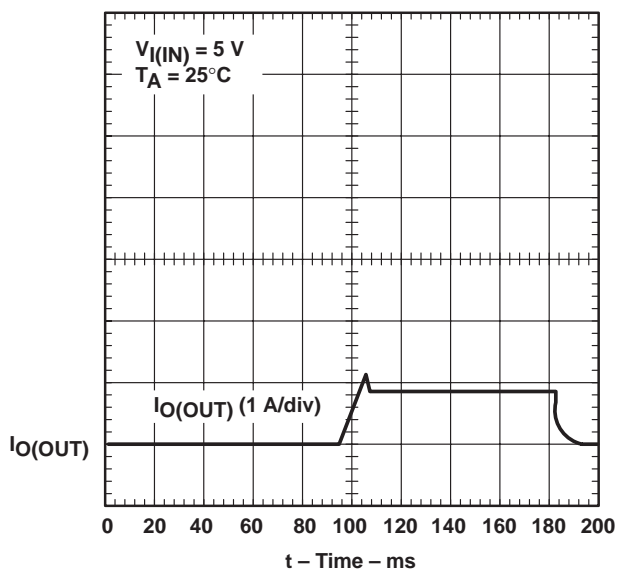

Figure 8. TPS2011A, Ramped Load on Enabled Device

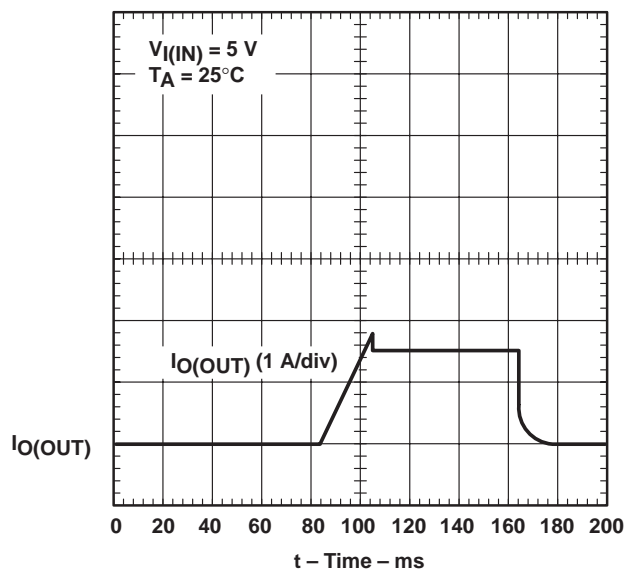

Figure 9. TPS2012A, Ramped Load on Enabled Device

# TPS2010A, TPS2011A, TPS2012A, TPS2013A POWER-DISTRIBUTION SWITCHES

SLVS189A – DECEMBER 1998 – REVISED NOVEMBER 1999

## PARAMETER MEASUREMENT INFORMATION

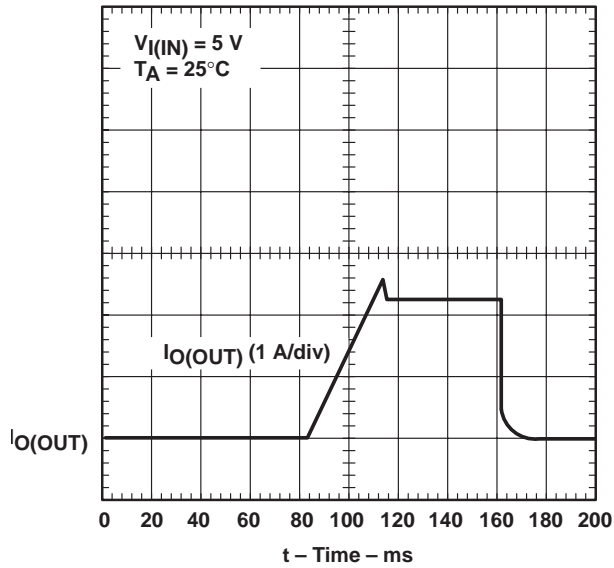

Figure 10. TPS2013A, Ramped Load on Enabled Device

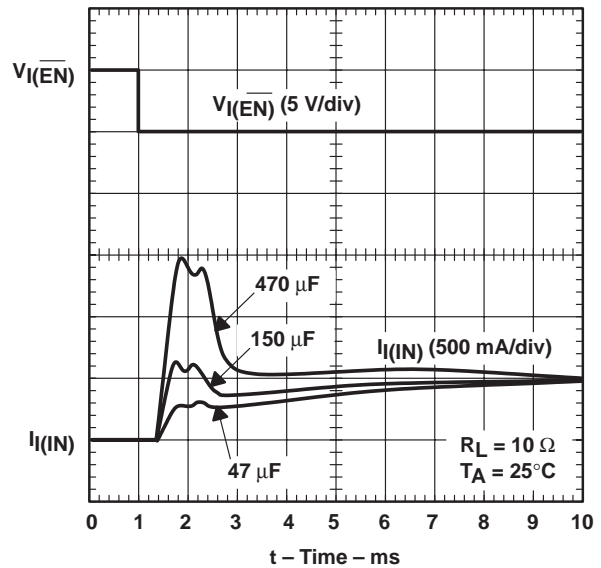

Figure 11. TPS2013A, Inrush Current

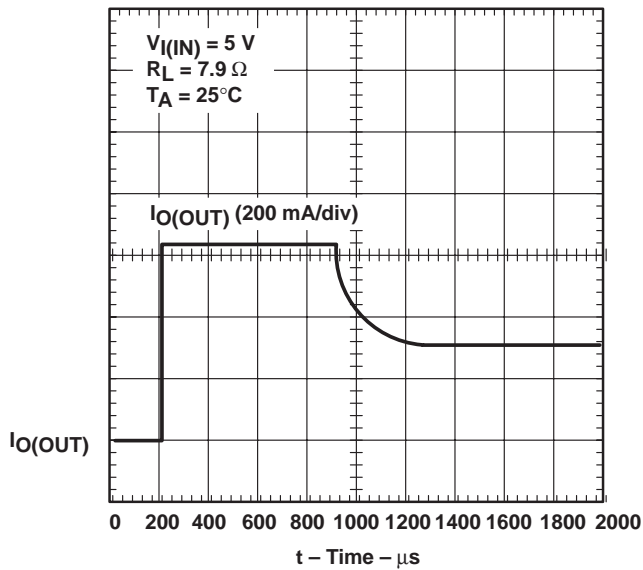

Figure 12. 7.9-Ω Load Connected to an Enabled TPS2010A Device

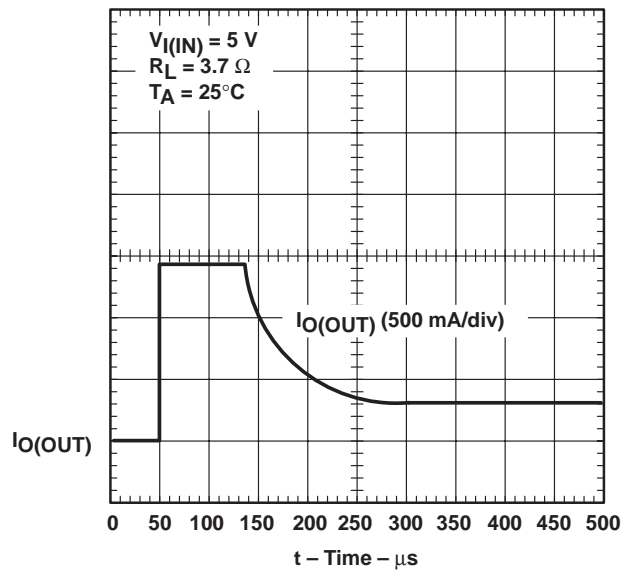

Figure 13. 3.7-Ω Load Connected to an Enabled TPS2010A Device



POST OFFICE BOX 655303 • DALLAS, TEXAS 75265

PARAMETER MEASUREMENT INFORMATION

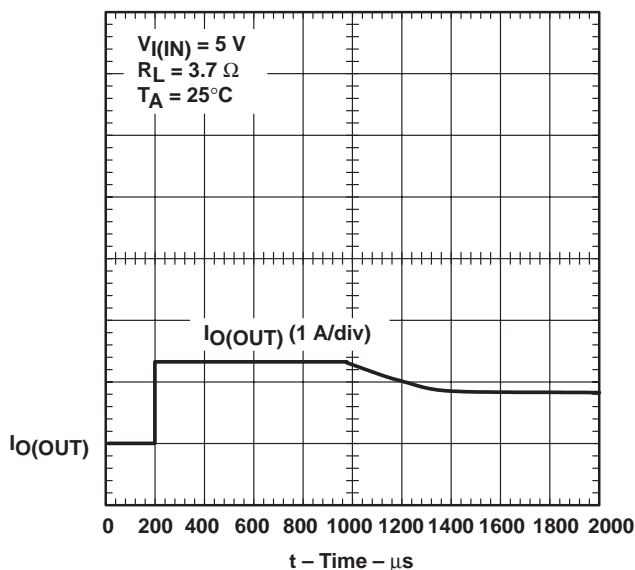

Figure 14. 3.7-Ω Load Connected to an Enabled TPS2011A Device

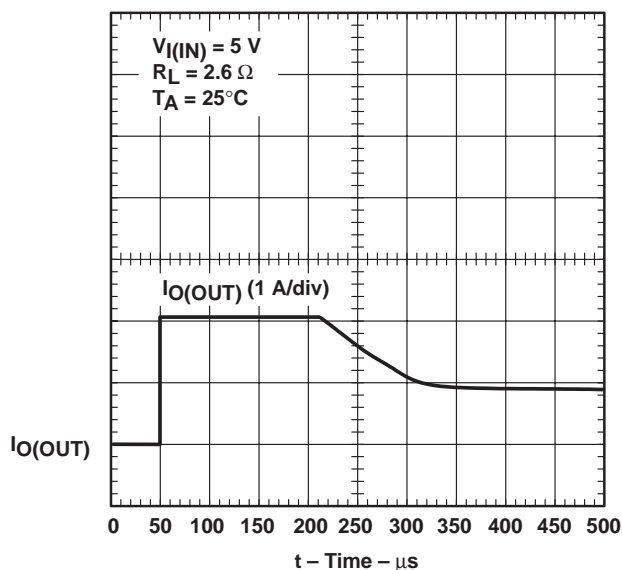

Figure 15. 2.6-Ω Load Connected to an Enabled TPS2011A Device

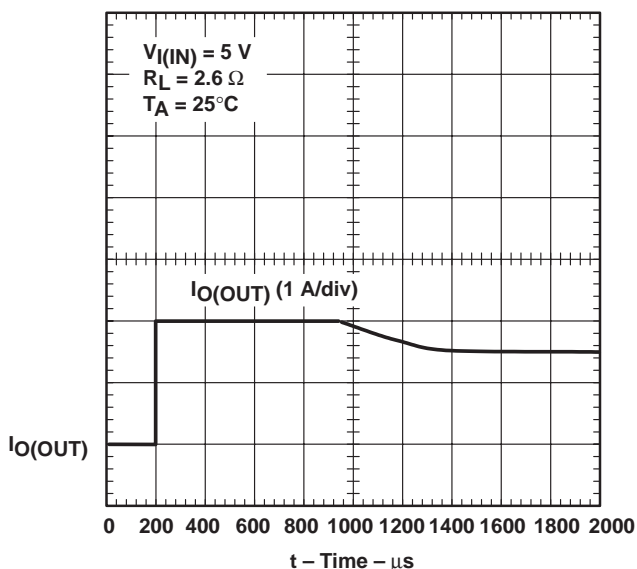

Figure 16. 2.6-Ω Load Connected to an Enabled TPS2012A Device

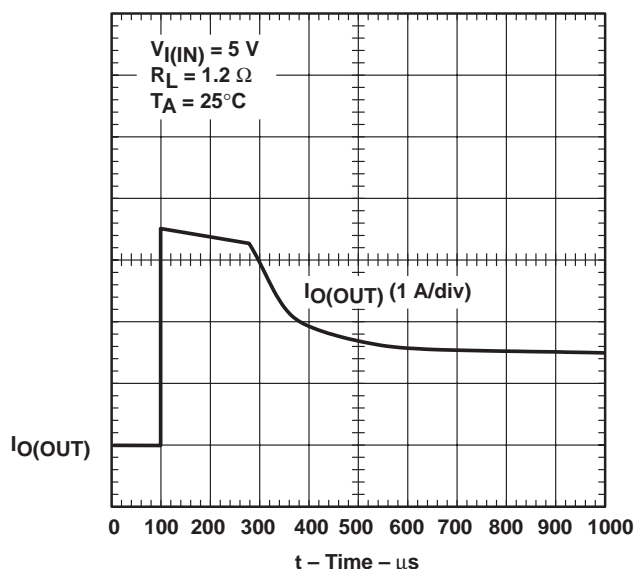

Figure 17. 1.2-Ω Load Connected to an Enabled TPS2012A Device

# TPS2010A, TPS2011A, TPS2012A, TPS2013A POWER-DISTRIBUTION SWITCHES

SLVS189A – DECEMBER 1998 – REVISED NOVEMBER 1999

## PARAMETER MEASUREMENT INFORMATION

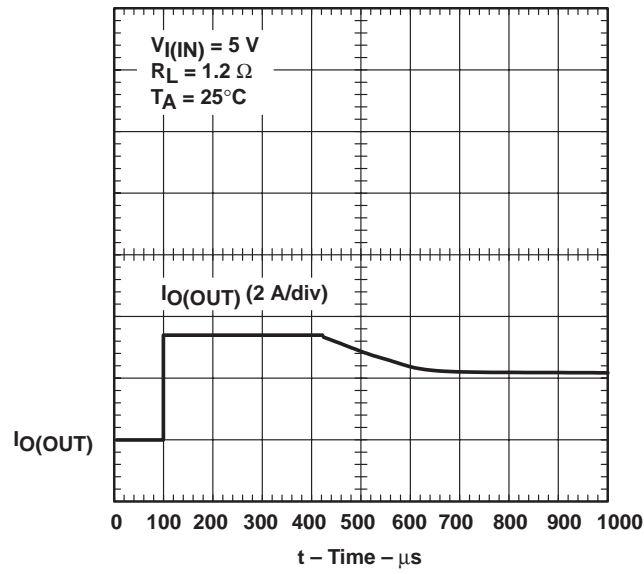

Figure 18. 1.2- $\Omega$  Load Connected to an Enabled TPS2013A Device

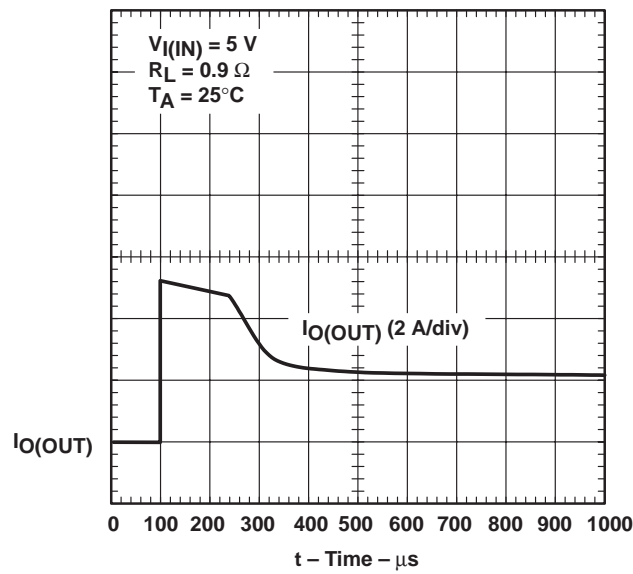

Figure 19. 0.9- $\Omega$  Load Connected to an Enabled TPS2013A Device

TYPICAL CHARACTERISTICS

Table of Graphs

			FIGURE
$t_{d(on)}$	Turnon delay time	vs Output voltage	20
$t_{d(off)}$	Turnoff delay time	vs Input voltage	21
$t_r$	Rise time	vs Load current	22
$t_f$	Fall time	vs Load current	23
	Supply current (enabled)	vs Junction temperature	24
	Supply current (disabled)	vs Junction temperature	25
	Supply current (enabled)	vs Input voltage	26
	Supply current (disabled)	vs Input voltage	27
$I_{OS}$	Short-circuit current limit	vs Input voltage	28
		vs Junction temperature	29
$r_{DS(on)}$	Static drain-source on-state resistance	vs Input voltage	30
		vs Junction temperature	31
		vs Input voltage	32
		vs Junction temperature	33
$V_I$	Input voltage	Undervoltage lockout	34

TURNON DELAY TIME  
vs  
OUTPUT VOLTAGE

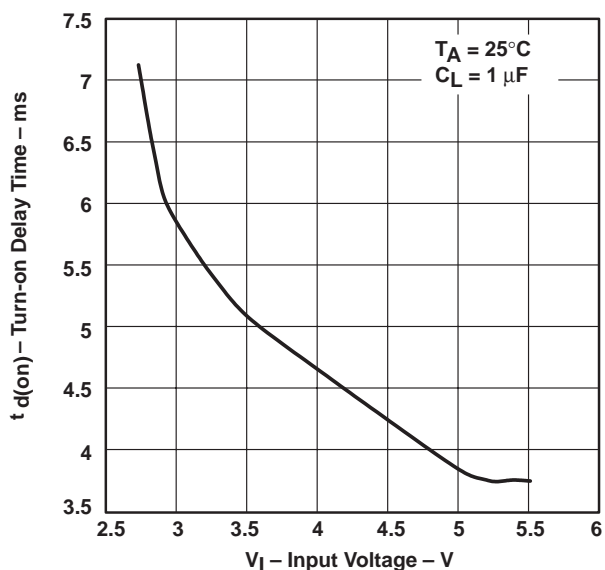

Figure 20

TURNOFF DELAY TIME  
vs  
INPUT VOLTAGE

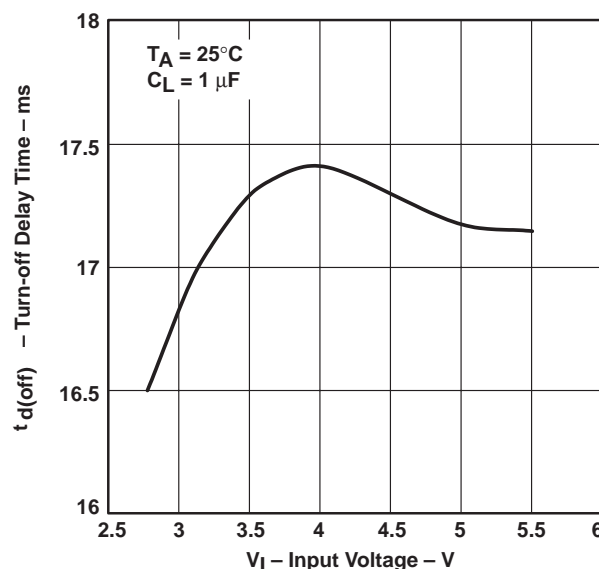

Figure 21

# TPS2010A, TPS2011A, TPS2012A, TPS2013A POWER-DISTRIBUTION SWITCHES

SLVS189A – DECEMBER 1998 – REVISED NOVEMBER 1999

## TYPICAL CHARACTERISTICS

**RISE TIME  
vs  
LOAD CURRENT**

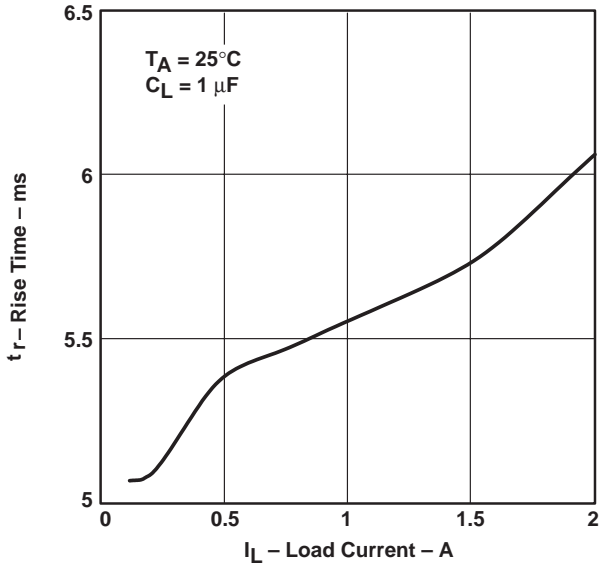

Figure 22

**FALL TIME  
vs  
LOAD CURRENT**

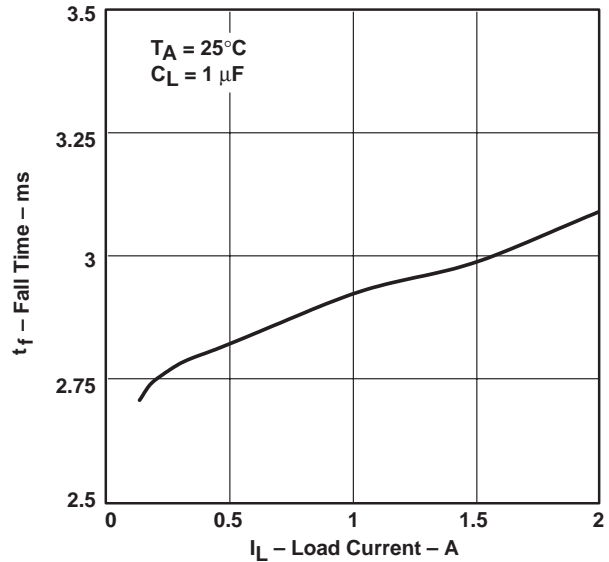

Figure 23

**SUPPLY CURRENT (ENABLED)  
vs  
JUNCTION TEMPERATURE**

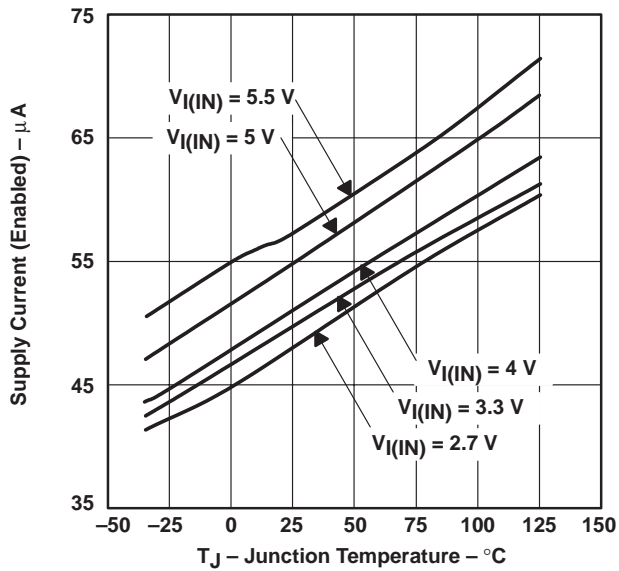

Figure 24

**SUPPLY CURRENT (DISABLED)  
vs  
JUNCTION TEMPERATURE**

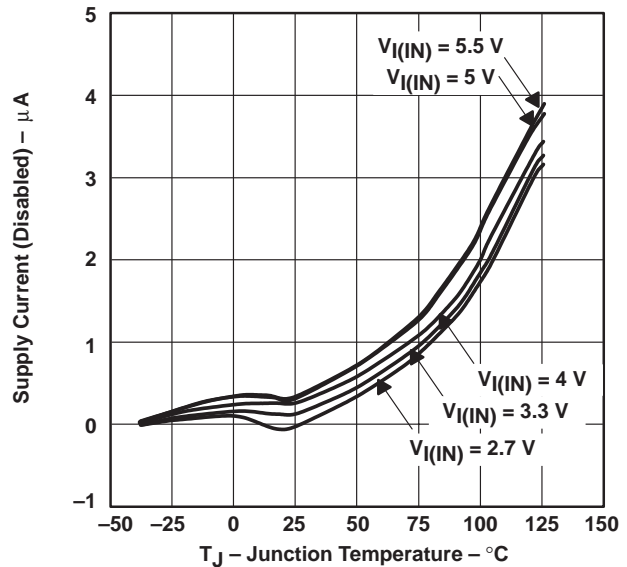

Figure 25



POST OFFICE BOX 655303 • DALLAS, TEXAS 75265

TYPICAL CHARACTERISTICS

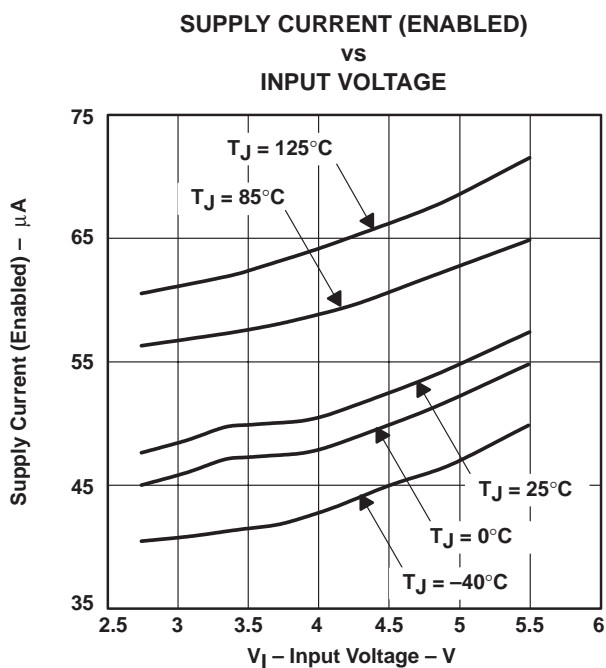

Figure 26

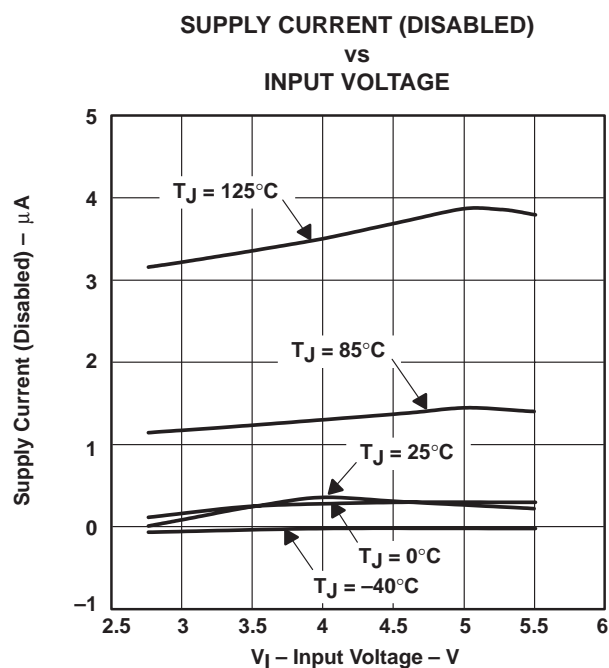

Figure 27

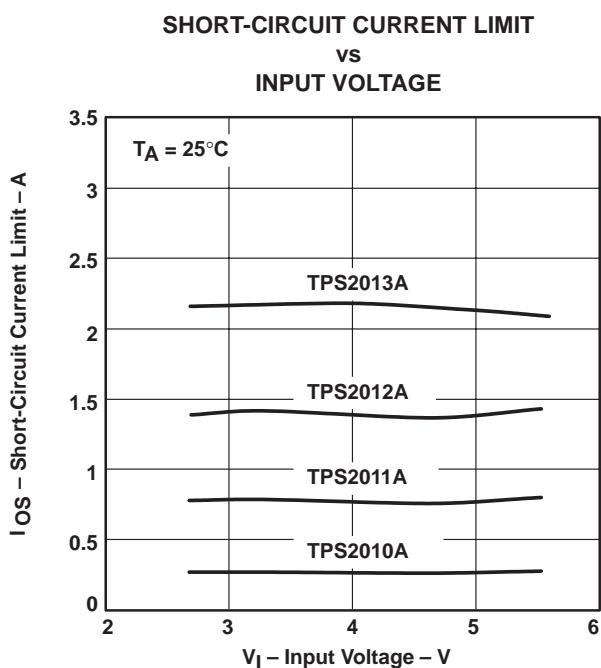

Figure 28

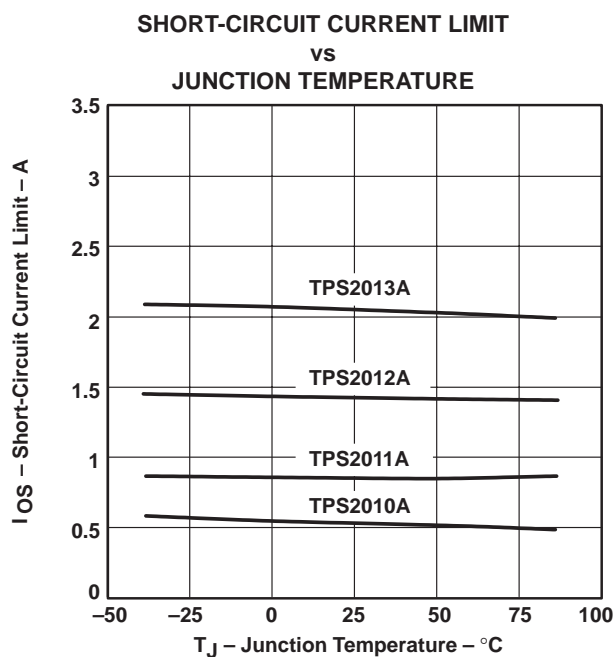

Figure 29

# TPS2010A, TPS2011A, TPS2012A, TPS2013A POWER-DISTRIBUTION SWITCHES

SLVS189A – DECEMBER 1998 – REVISED NOVEMBER 1999

## TYPICAL CHARACTERISTICS

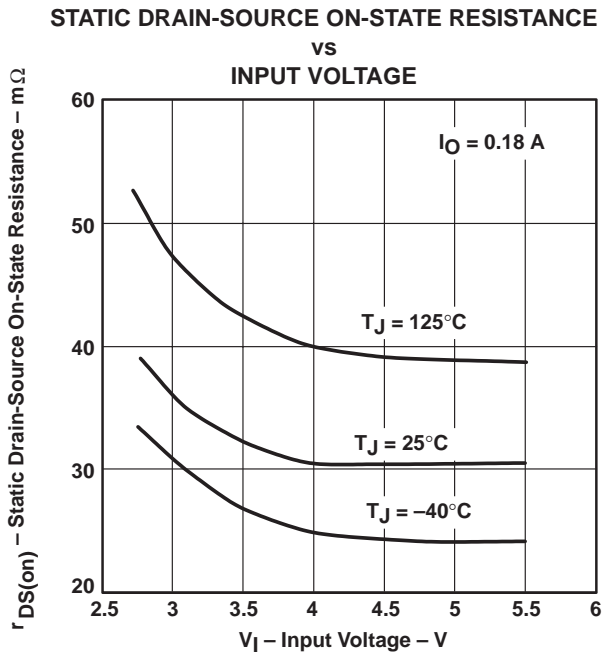

Figure 30

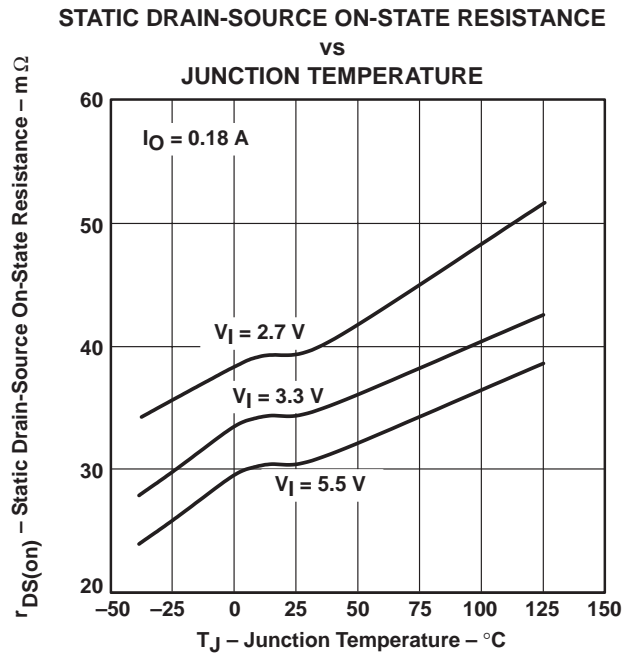

Figure 31

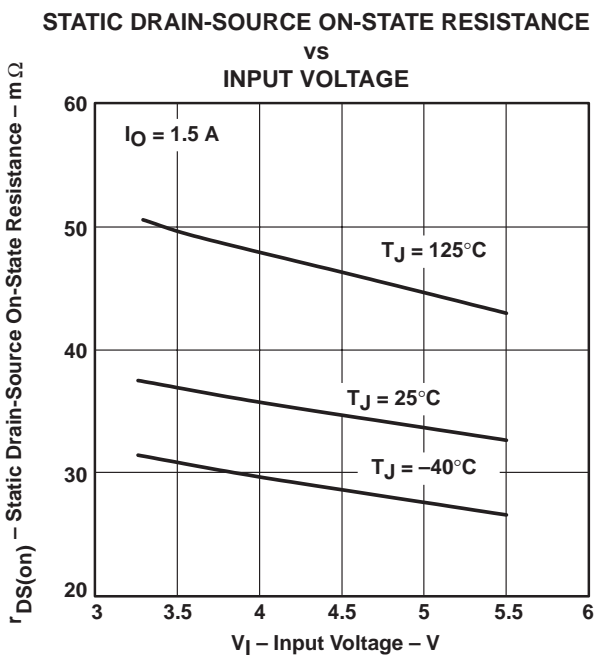

Figure 32

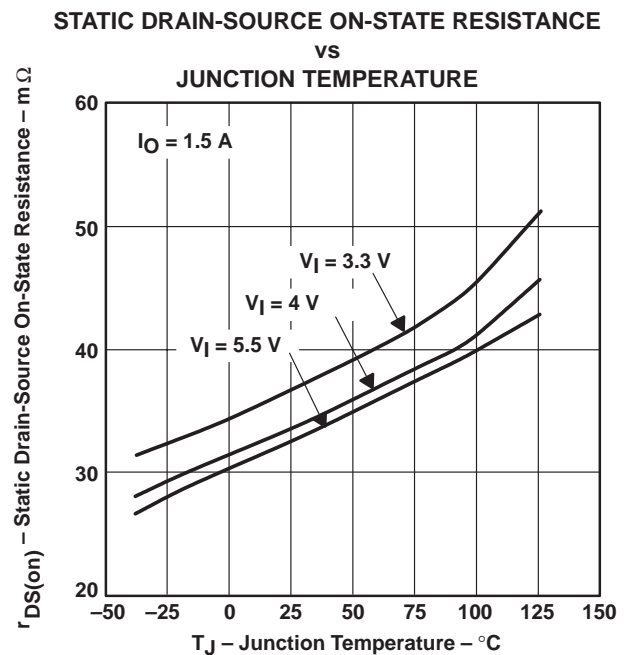

Figure 33



TYPICAL CHARACTERISTICS

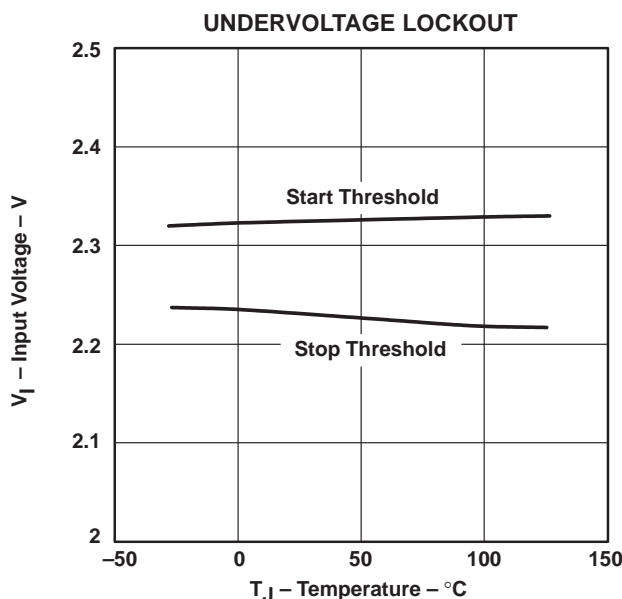

Figure 34

APPLICATION INFORMATION

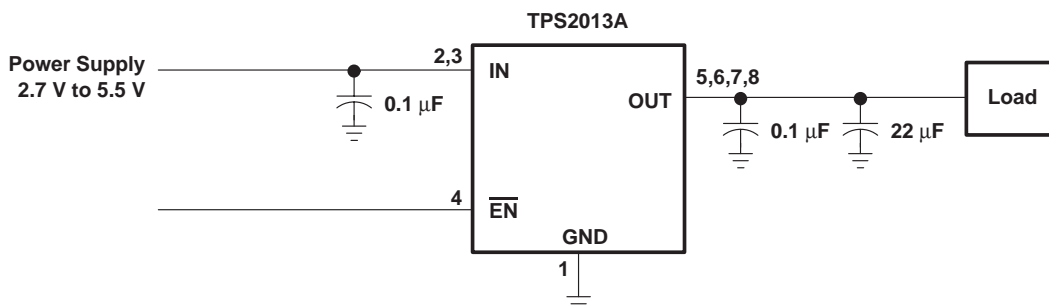

Figure 35. Typical Application

**power-supply considerations**

A 0.01-μF to 0.1-μF ceramic bypass capacitor between IN and GND, close to the device, is recommended. Placing a high-value electrolytic capacitor on the output and input pins is recommended when the output load is heavy. This precaution reduces power supply transients that may cause ringing on the input. Additionally, bypassing the output with a 0.01-μF to 0.1-μF ceramic capacitor improves the immunity of the device to short-circuit transients.

**overcurrent**

A sense FET checks for overcurrent conditions. Unlike current-sense resistors, sense FETs do not increase the series resistance of the current path. When an overcurrent condition is detected, the device maintains a constant output current and reduces the output voltage accordingly. Complete shutdown occurs only if the fault is present long enough to activate thermal limiting.

# TPS2010A, TPS2011A, TPS2012A, TPS2013A POWER-DISTRIBUTION SWITCHES

SLVS189A – DECEMBER 1998 – REVISED NOVEMBER 1999

---

## APPLICATION INFORMATION

### overcurrent (continued)

Three possible overload conditions can occur. In the first condition, the output has been shorted before the device is enabled or before  $V_{I(IN)}$  has been applied (see Figure 6). The TPS201xA senses the short and immediately switches into a constant-current output.

In the second condition, the excessive load occurs while the device is enabled. At the instant the excessive load occurs, very high currents may flow for a short time before the current-limit circuit can react (see Figures 12–19). After the current-limit circuit has tripped (reached the overcurrent trip threshold) the device switches into constant-current mode.

In the third condition, the load has been gradually increased beyond the recommended operating current. The current is permitted to rise until the current-limit threshold is reached or until the thermal limit of the device is exceeded (see Figures 7–10). The TPS201xA is capable of delivering current up to the current-limit threshold without damaging the device. Once the threshold has been reached, the device switches into its constant-current mode.

### power dissipation and junction temperature

The low on-resistance on the n-channel MOSFET allows small surface-mount packages, such as SOIC, to pass large currents. The thermal resistances of these packages are high compared to those of power packages; it is good design practice to check power dissipation and junction temperature. The first step is to find  $r_{DS(on)}$  at the input voltage and operating temperature. As an initial estimate, use the highest operating ambient temperature of interest and read  $r_{DS(on)}$  from Figures 30–33. Next, calculate the power dissipation using:

$$P_D = r_{DS(on)} \times I^2$$

Finally, calculate the junction temperature:

$$T_J = P_D \times R_{\theta JA} + T_A$$

Where:

$T_A$  = Ambient Temperature °C

$R_{\theta JA}$  = Thermal resistance SOIC = 172°C/W

Compare the calculated junction temperature with the initial estimate. If they do not agree within a few degrees, repeat the calculation, using the calculated value as the new estimate. Two or three iterations are generally sufficient to get an acceptable answer.

### thermal protection

Thermal protection prevents damage to the IC when heavy-overload or short-circuit faults are present for extended periods of time. The faults force the TPS201xA into constant current mode, which causes the voltage across the high-side switch to increase; under short-circuit conditions, the voltage across the switch is equal to the input voltage. The increased dissipation causes the junction temperature to rise to high levels. The protection circuit senses the junction temperature of the switch and shuts it off. Hysteresis is built into the thermal sense circuit, and after the device has cooled approximately 20 degrees, the switch turns back on. The switch continues to cycle in this manner until the load fault or input power is removed.



POST OFFICE BOX 655303 • DALLAS, TEXAS 75265

## APPLICATION INFORMATION

### undervoltage lockout (UVLO)

An undervoltage lockout ensures that the power switch is in the off state at power up. Whenever the input voltage falls below approximately 2 V, the power switch will be quickly turned off. This facilitates the design of hot-insertion systems where it is not possible to turn off the power switch before input power is removed. The UVLO will also keep the switch from being turned on until the power supply has reached at least 2 V, even if the switch is enabled. Upon reinsertion, the power switch will be turned on, with a controlled rise time to reduce EMI and voltage overshoots.

### generic hot-plug applications (see Figure 36)

In many applications it may be necessary to remove modules or pc boards while the main unit is still operating. These are considered hot-plug applications. Such implementations require the control of current surges seen by the main power supply and the card being inserted. The most effective way to control these surges is to limit and slowly ramp the current and voltage being applied to the card, similar to the way in which a power supply normally turns on. Because of the controlled rise times and fall times of the TPS201xA series, these devices can be used to provide a softer start-up to devices being hot-plugged into a powered system. The UVLO feature of the TPS201xA also ensures the switch will be off after the card has been removed, and the switch will be off during the next insertion. The UVLO feature guarantees a soft start with a controlled rise time for every insertion of the card or module.

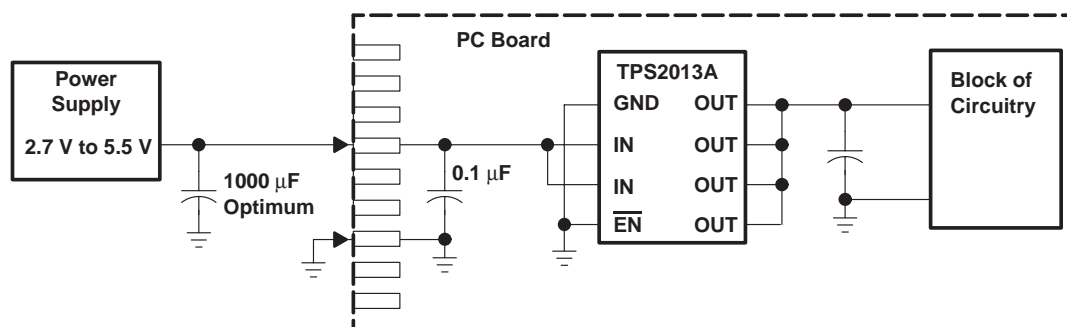

Figure 36. Typical Hot-Plug Implementation

By placing the TPS201xA between the  $V_{CC}$  input and the rest of the circuitry, the input power will reach this device first after insertion. The typical rise time of the switch is approximately 9 ms, providing a slow voltage ramp at the output of the device. This implementation controls system surge currents and provides a hot-plugging mechanism for any device.

# TPS2010A, TPS2011A, TPS2012A, TPS2013A POWER-DISTRIBUTION SWITCHES

SLVS189A – DECEMBER 1998 – REVISED NOVEMBER 1999

## MECHANICAL DATA

D (R-PDSO-G\*\*)

PLASTIC SMALL-OUTLINE PACKAGE

14 PIN SHOWN

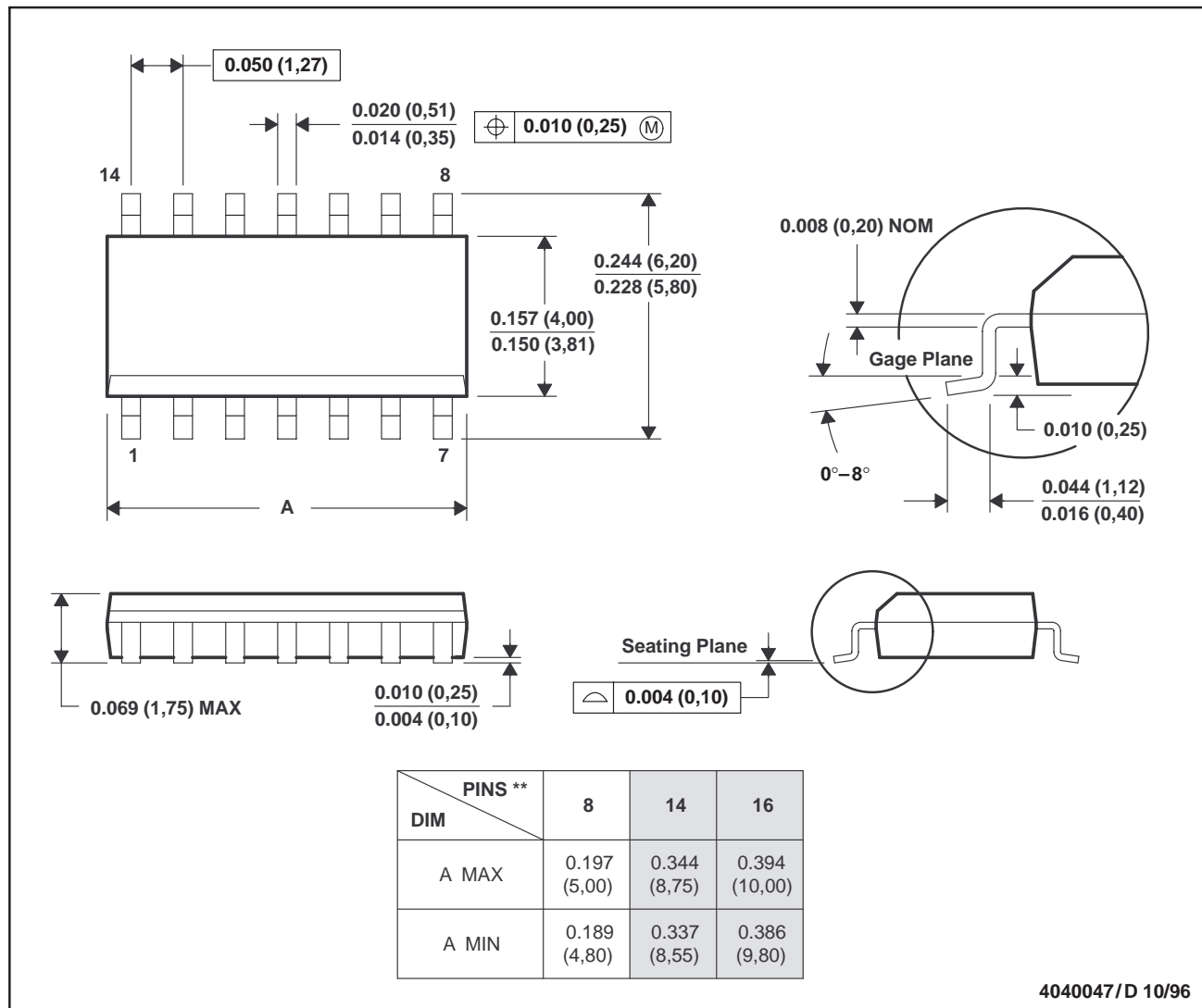

4040047/D 10/96

- NOTES: A. All linear dimensions are in inches (millimeters).  
 B. This drawing is subject to change without notice.  
 C. Body dimensions do not include mold flash or protrusion, not to exceed 0.006 (0,15).  
 D. Falls within JEDEC MS-012



POST OFFICE BOX 655303 • DALLAS, TEXAS 75265

# TPS2010A, TPS2011A, TPS2012A, TPS2013A POWER-DISTRIBUTION SWITCHES

SLVS189A – DECEMBER 1998 – REVISED NOVEMBER 1999

## MECHANICAL DATA

PWP (R-PDSO-G\*\*)

PowerPAD™ PLASTIC SMALL-OUTLINE PACKAGE

20-PIN SHOWN

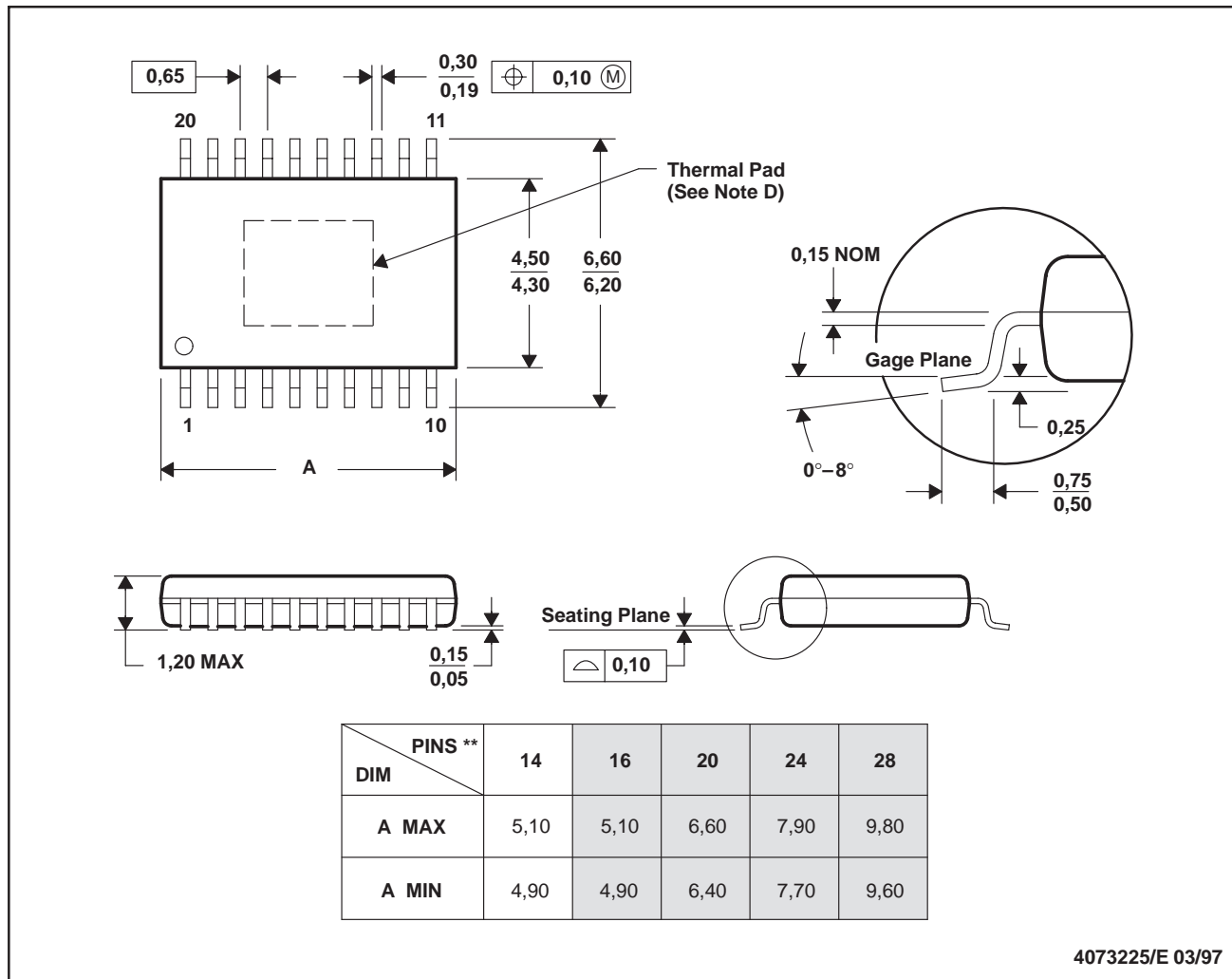

- NOTES: A. All linear dimensions are in millimeters.  
 B. This drawing is subject to change without notice.  
 C. Body dimensions do not include mold flash or protrusions.  
 D. The package thermal performance may be enhanced by bonding the thermal pad to an external thermal plane. This pad is electrically and thermally connected to the backside of the die and possibly selected leads.  
 E. Falls within JEDEC MO-153

PowerPAD is a trademark of Texas Instruments Incorporated.



POST OFFICE BOX 655303 • DALLAS, TEXAS 75265

## **IMPORTANT NOTICE**

Texas Instruments and its subsidiaries (TI) reserve the right to make changes to their products or to discontinue any product or service without notice, and advise customers to obtain the latest version of relevant information to verify, before placing orders, that information being relied on is current and complete. All products are sold subject to the terms and conditions of sale supplied at the time of order acknowledgement, including those pertaining to warranty, patent infringement, and limitation of liability.

TI warrants performance of its semiconductor products to the specifications applicable at the time of sale in accordance with TI's standard warranty. Testing and other quality control techniques are utilized to the extent TI deems necessary to support this warranty. Specific testing of all parameters of each device is not necessarily performed, except those mandated by government requirements.

CERTAIN APPLICATIONS USING SEMICONDUCTOR PRODUCTS MAY INVOLVE POTENTIAL RISKS OF DEATH, PERSONAL INJURY, OR SEVERE PROPERTY OR ENVIRONMENTAL DAMAGE ("CRITICAL APPLICATIONS"). TI SEMICONDUCTOR PRODUCTS ARE NOT DESIGNED, AUTHORIZED, OR WARRANTED TO BE SUITABLE FOR USE IN LIFE-SUPPORT DEVICES OR SYSTEMS OR OTHER CRITICAL APPLICATIONS. INCLUSION OF TI PRODUCTS IN SUCH APPLICATIONS IS UNDERSTOOD TO BE FULLY AT THE CUSTOMER'S RISK.

In order to minimize risks associated with the customer's applications, adequate design and operating safeguards must be provided by the customer to minimize inherent or procedural hazards.

TI assumes no liability for applications assistance or customer product design. TI does not warrant or represent that any license, either express or implied, is granted under any patent right, copyright, mask work right, or other intellectual property right of TI covering or relating to any combination, machine, or process in which such semiconductor products or services might be or are used. TI's publication of information regarding any third party's products or services does not constitute TI's approval, warranty or endorsement thereof.