

# Low-Power BiCMOS Current-Mode PWM

## FEATURES

- 100 $\mu$ A Typical Starting Supply Current
- 500 $\mu$ A Typical Operating Supply Current
- Operation to 1MHz
- Internal Soft Start
- Internal Fault Soft Start
- Internal Leading-Edge Blanking of the Current Sense Signal
- 1 Amp Totem-Pole Output
- 70ns Typical Response from Current-Sense to Gate Drive Output
- 1.5% Tolerance Voltage Reference
- Same Pinout as UC3842 and UC3842A

## DESCRIPTION

The UCC1800/1/2/3/4/5 family of high-speed, low-power integrated circuits contain all of the control and drive components required for off-line and DC-to-DC fixed frequency current-mode switching power supplies with minimal parts count.

These devices have the same pin configuration as the UC1842/3/4/5 family, and also offer the added features of internal full-cycle soft start and internal leading-edge blanking of the current-sense input.

The UCC1800/1/2/3/4/5 family offers a variety of package options, temperature range options, choice of maximum duty cycle, and choice of critical voltage levels. Lower reference parts such as the UCC1803 and UCC1805 fit best into battery operated systems, while the higher reference and the higher UVLO hysteresis of the UCC1802 and UCC1804 make these ideal choices for use in off-line power supplies.

The UCC180x series is specified for operation from  $-55^{\circ}\text{C}$  to  $+125^{\circ}\text{C}$ , the UCC280x series is specified for operation from  $-40^{\circ}\text{C}$  to  $+85^{\circ}\text{C}$ , and the UCC380x series is specified for operation from  $0^{\circ}\text{C}$  to  $+70^{\circ}\text{C}$ .

| Part Number | Maximum Duty Cycle | Reference Voltage | Turn-On Threshold | Turn-Off Threshold |
|-------------|--------------------|-------------------|-------------------|--------------------|
| UCCx800     | 100%               | 5V                | 7.2V              | 6.9V               |
| UCCx801     | 50%                | 5V                | 9.4V              | 7.4V               |
| UCCx802     | 100%               | 5V                | 12.5V             | 8.3V               |
| UCCx803     | 100%               | 4V                | 4.1V              | 3.6V               |
| UCCx804     | 50%                | 5V                | 12.5V             | 8.3V               |
| UCCx805     | 50%                | 4V                | 4.1V              | 3.6V               |

## BLOCK DIAGRAM

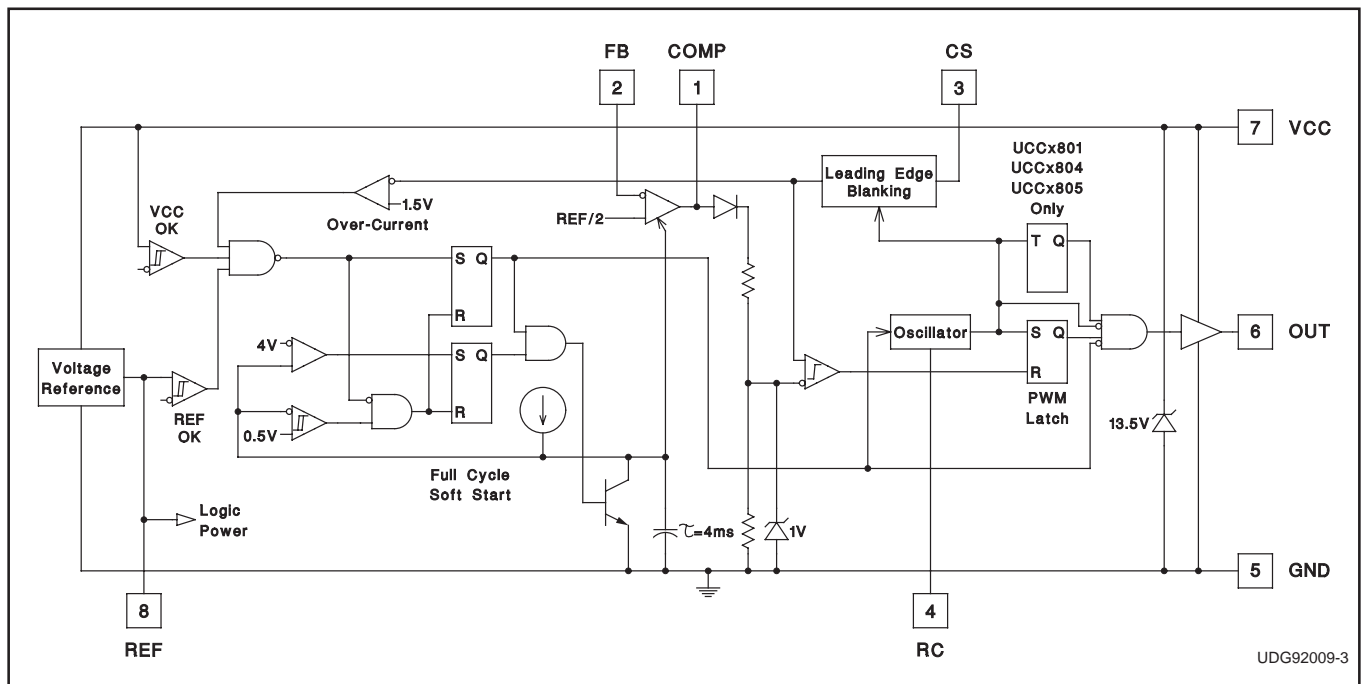

UDG92009-3

### ABSOLUTE MAXIMUM RATINGS (Note 1)

|  |                 |
|--|-----------------|
| V <sub>CC</sub> Voltage (Note 2)                             | 12.0V           |
| V <sub>CC</sub> Current                                      | 30.0mA          |
| OUT Current  | ±1.0A           |
| OUT Energy (Capacitive Load)                                 | 20.0μJ          |
| Analog Inputs (FB, CS)                                       | -0.3V to 6.3V   |
| Power Dissipation at T <sub>A</sub> < +25°C (N or J Package) | 1.0W            |
| Power Dissipation at T <sub>A</sub> < +25°C (D Package)      | 0.65W           |
| Storage Temperature Range                                    | -65°C to +150°C |
| Lead Temperature (Soldering, 10 Seconds)                     | +300°C          |

Note 1: All voltages are with respect to GND. All currents are positive into the specified terminal. Consult Unitorde databook for information regarding thermal specifications and limitations of packages.

Note 2: In normal operation V<sub>CC</sub> is powered through a current limiting resistor. Absolute maximum of 12V applies when V<sub>CC</sub> is driven from a low impedance source such that I<sub>CC</sub> does not exceed 30mA.

### TEMPERATURE AND PACKAGE SELECTION

|         | Temperature Range | Available Packages |
|---------|-------------------|--------------------|
| UCC1800 | -55°C to +125°C   | J                  |
| UCC2800 | -40°C to +85°C    | N, D, PW           |
| UCC3800 | 0°C to +70°C      | N, D, PW           |

### ORDERING INFORMATION

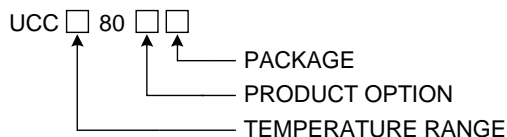

### CONNECTION DIAGRAMS

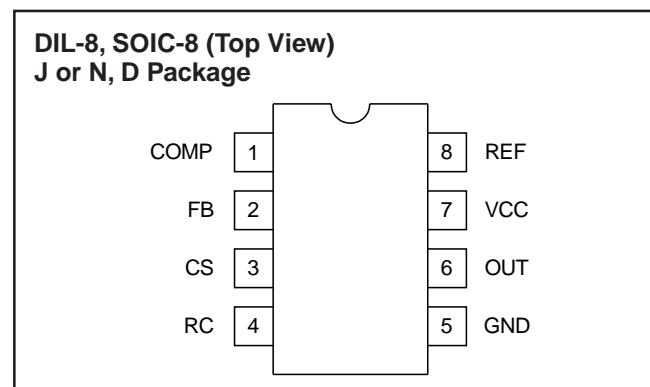
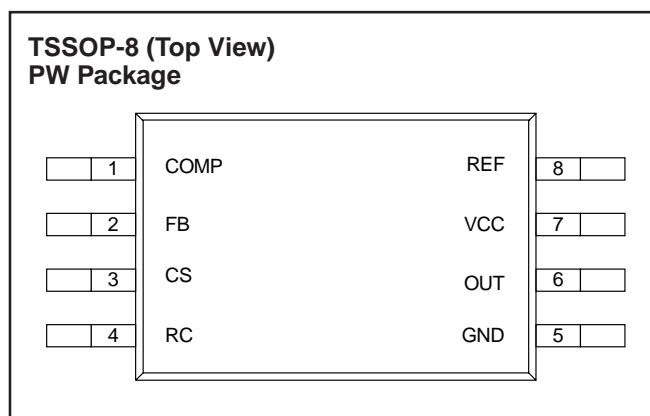

**ELECTRICAL CHARACTERISTICS** Unless otherwise stated, these specifications apply for -55°C ≤ T<sub>A</sub> ≤ +125°C for UCC180x; -40°C ≤ T<sub>A</sub> ≤ +85°C for UCC280x; 0°C ≤ T<sub>A</sub> ≤ +70°C for UCC380x; V<sub>CC</sub>=10V (Note 3); RT=100k from REF to RC; CT=330pF from RC to GND; 0.1μF capacitor from V<sub>CC</sub> to GND; 0.1μF capacitor from V<sub>REF</sub> to GND. T<sub>A</sub>=T<sub>J</sub>.

| PARAMETER                 | TEST CONDITIONS                                  | UCC180X<br>UCC280X |      |       | UCC380X |      |       | UNITS |
|---------------------------|--|--------------------|------|-------|---------|------|-------|-------|
|                           |  | MIN                | TYP  | MAX   | MIN     | TYP  | MAX   |       |
| <b>Reference Section</b>  |  |                    |      |       |         |      |       |       |
| Output Voltage            | T <sub>J</sub> =+25°C, I=0.2mA, UCCx800/1/2/4    | 4.925              | 5.00 | 5.075 | 4.925   | 5.00 | 5.075 | V     |
|                           | T <sub>J</sub> =+25°C, I=0.2mA, UCCx803/5        | 3.94               | 4.00 | 4.06  | 3.94    | 4.00 | 4.06  |       |
| Load Regulation           | 0.2mA < I < 5mA                                  |                    | 10   | 30    |         | 10   | 25    | mV    |
| Total Variation           | UCCx800/1/2/4 (Note 7)                           | 4.88               | 5.00 | 5.10  | 4.88    | 5.00 | 5.10  | V     |
|                           | UCCx803/5 (Note 7)                               | 3.90               | 4.00 | 4.08  | 3.90    | 4.00 | 4.08  | V     |
| Output Noise Voltage      | 10Hz ≤ f ≤ 10kHz, T <sub>J</sub> =+25°C (Note 9) |                    | 130  |       |         | 130  |       | μV    |
| Long Term Stability       | T <sub>A</sub> =+125°C, 1000 Hours (Note 9)      |                    | 5    |       |         | 5    |       | mV    |
| Output Short Circuit      |  | -5                 |      | -35   | -5      |      | -35   | mA    |
| <b>Oscillator Section</b> |  |                    |      |       |         |      |       |       |
| Oscillator Frequency      | UCCx800/1/2/4 (Note 4)                           | 40                 | 46   | 52    | 40      | 46   | 52    | kHz   |
|                           | UCCx803/5 (Note 4)                               | 26                 | 31   | 36    | 26      | 31   | 36    |       |
| Temperature Stability     | (Note 9)   |                    | 2.5  |       |         | 2.5  |       | %     |
| Amplitude peak-to-peak    |  | 2.25               | 2.40 | 2.55  | 2.25    | 2.40 | 2.55  | V     |
| Oscillator Peak Voltage   |  |                    | 2.45 |       |         | 2.45 |       | V     |

**UCC1800/1/2/3/4/5**  
**UCC2800/1/2/3/4/5**  
**UCC3800/1/2/3/4/5**

**ELECTRICAL CHARACTERISTICS** Unless otherwise stated, these specifications apply for  $-55^{\circ}\text{C} \leq T_A \leq +125^{\circ}\text{C}$  for UCC180x;  $-40^{\circ}\text{C} \leq T_A \leq +85^{\circ}\text{C}$  for UCC280x;  $0^{\circ}\text{C} \leq T_A \leq +70^{\circ}\text{C}$  for UCC380x;  $V_{CC}=10\text{V}$  (Note 3);  $RT=100\text{k}$  from REF to RC;  $CT=330\text{pF}$  from RC to GND;  $0.1\mu\text{F}$  capacitor from  $V_{CC}$  to GND;  $0.1\mu\text{F}$  capacitor from  $V_{REF}$  to GND.  $T_A=T_J$ .

| PARAMETER                              | TEST CONDITIONS            | UCC180X<br>UCC280X |      |      | UCC380X |      |      | UNITS         |
|--|----------------------------|--------------------|------|------|---------|------|------|---------------|
| <b>Error Amplifier Section</b>         |                            |                    |      |      |         |      |      |               |
| Input Voltage                          | COMP=2.5V; UCCx800/1/2/4   | 2.44               | 2.50 | 2.56 | 2.44    | 2.50 | 2.56 | V             |
|  | COMP=2.0V; UCCx803/5       | 1.95               | 2.0  | 2.05 | 1.95    | 2.0  | 2.05 |               |
| Input Bias Current                     |                            | -1                 |      | 1    | -1      |      | 1    | $\mu\text{A}$ |
| Open Loop Voltage Gain                 |                            | 60                 | 80   |      | 60      | 80   |      | dB            |
| COMP Sink Current                      | FB=2.7V, COMP=1.1V         | 0.3                |      | 3.5  | 0.4     |      | 2.5  | mA            |
| COMP Source Current                    | FB=1.8V, COMP=REF-1.2V     | -0.2               | -0.5 | -0.8 | -0.2    | -0.5 | -0.8 | mA            |
| Gain Bandwidth Product                 | (Note 9)                   |                    | 2    |      |         | 2    |      | MHz           |
| <b>PWM Section</b>                     |                            |                    |      |      |         |      |      |               |
| Maximum Duty Cycle                     | UCCx800/2/3                | 97                 | 99   | 100  | 97      | 99   | 100  | %             |
|  | UCCx801/4/5                | 48                 | 49   | 50   | 48      | 49   | 50   |               |
| Minimum Duty Cycle                     | COMP=0V                    |                    |      | 0    |         |      | 0    | %             |
| <b>Current Sense Section</b>           |                            |                    |      |      |         |      |      |               |
| Gain                                   | (Note 5)                   | 1.10               | 1.65 | 1.80 | 1.10    | 1.65 | 1.80 | V/V           |
| Maximum Input Signal                   | COMP=5V (Note 6)           | 0.9                | 1.0  | 1.1  | 0.9     | 1.0  | 1.1  | V             |
| Input Bias Current                     |                            | -200               |      | 200  | -200    |      | 200  | nA            |
| CS Blank Time                          |                            | 50                 | 100  | 150  | 50      | 100  | 150  | ns            |
| Over-Current Threshold                 |                            | 1.42               | 1.55 | 1.68 | 1.42    | 1.55 | 1.68 | V             |
| COMP to CS Offset                      | CS=0V                      | 0.45               | 0.90 | 1.35 | 0.45    | 0.90 | 1.35 | V             |
| <b>Output Section</b>                  |                            |                    |      |      |         |      |      |               |
| OUT Low Level                          | I=20mA, all parts          |                    | 0.1  | 0.4  |         | 0.1  | 0.4  | V             |
|  | I=200mA, all parts         |                    | 0.35 | 0.90 |         | 0.35 | 0.90 | V             |
|  | I=50mA, VCC=5V, UCCx803/5  |                    | 0.15 | 0.40 |         | 0.15 | 0.40 | V             |
|  | I=20mA, VCC=0V, all parts  |                    | 0.7  | 1.2  |         | 0.7  | 1.2  | V             |
| OUT High $V_{SAT}$<br>( $V_{CC}-OUT$ ) | I=-20mA, all parts         |                    | 0.15 | 0.40 |         | 0.15 | 0.40 | V             |
|  | I=-200mA, all parts        |                    | 1.0  | 1.9  |         | 1.0  | 1.9  | V             |
|  | I=-50mA, VCC=5V, UCCx803/5 |                    | 0.4  | 0.9  |         | 0.4  | 0.9  | V             |
| Rise Time                              | $C_L=1\text{nF}$           |                    | 41   | 70   |         | 41   | 70   | ns            |
| Fall Time                              | $C_L=1\text{nF}$           |                    | 44   | 75   |         | 44   | 75   | ns            |
| <b>Undervoltage Lockout Section</b>    |                            |                    |      |      |         |      |      |               |
| Start Threshold (Note 8)               | UCCx800                    | 6.6                | 7.2  | 7.8  | 6.6     | 7.2  | 7.8  | V             |
|  | UCCx801                    | 8.6                | 9.4  | 10.2 | 8.6     | 9.4  | 10.2 | V             |
|  | UCCx802/4                  | 11.5               | 12.5 | 13.5 | 11.5    | 12.5 | 13.5 | V             |
|  | UCCx803/5                  | 3.7                | 4.1  | 4.5  | 3.7     | 4.1  | 4.5  | V             |
| Stop Threshold (Note 8)                | UCCx1800                   | 6.3                | 6.9  | 7.5  | 6.3     | 6.9  | 7.5  | V             |
|  | UCCx1801                   | 6.8                | 7.4  | 8.0  | 6.8     | 7.4  | 8.0  | V             |
|  | UCCx802/4                  | 7.6                | 8.3  | 9.0  | 7.6     | 8.3  | 9.0  | V             |
|  | UCCx803/5                  | 3.2                | 3.6  | 4.0  | 3.2     | 3.6  | 4.0  | V             |
| Start to Stop Hysteresis               | UCCx800                    | 0.12               | 0.3  | 0.48 | 0.12    | 0.3  | 0.48 | V             |
|  | UCCx801                    | 1.6                | 2    | 2.4  | 1.6     | 2    | 2.4  | V             |
|  | UCCx802/4                  | 3.5                | 4.2  | 5.1  | 3.5     | 4.2  | 5.1  | V             |
|  | UCCx803/5                  | 0.2                | 0.5  | 0.8  | 0.2     | 0.5  | 0.8  | V             |

**ELECTRICAL CHARACTERISTICS** Unless otherwise stated, these specifications apply for  $-55^{\circ}\text{C} \leq T_A \leq +125^{\circ}\text{C}$  for UCC180x;  $-40^{\circ}\text{C} \leq T_A \leq +85^{\circ}\text{C}$  for UCC280x;  $0^{\circ}\text{C} \leq T_A \leq +70^{\circ}\text{C}$  for UCC380x;  $V_{CC}=10\text{V}$  (Note 3);  $RT=100\text{k}$  from REF to RC;  $CT=330\text{pF}$  from RC to GND;  $0.1\mu\text{F}$  capacitor from  $V_{CC}$  to GND;  $0.1\mu\text{F}$  capacitor from  $V_{REF}$  to GND.  $T_A=T_J$ .

| PARAMETER  | TEST CONDITIONS                   | UCC180X<br>UCC280X |      | UCC380X |     | UNITS |    |   |
|--|-----------------------------------|--------------------|------|---------|-----|-------|----|---|
| <b>Soft Start Section</b>                                |                                   |                    |      |         |     |       |    |   |
| COMP Rise Time   | FB=1.8V, Rise from 0.5V to REF-1V | 4                  | 10   | 4       | 10  | ms    |    |   |
| <b>Overall Section</b>                                   |                                   |                    |      |         |     |       |    |   |
| Start-up Current   | $V_{CC} < \text{Start Threshold}$ | 0.1                | 0.2  | 0.1     | 0.2 | mA    |    |   |
| Operating Supply Current                                 | FB=0V, CS=0V                      | 0.5                | 1.0  | 0.5     | 1.0 | mA    |    |   |
| VCC Internal Zener Voltage                               | $I_{CC}=10\text{mA}$ (Note 8)     | 12                 | 13.5 | 15      | 12  | 13.5  | 15 | V |
| VCC Internal Zener Voltage Minus Start Threshold Voltage | UCCx802/4                         | 0.5                | 1.0  |         | 0.5 | 1.0   |    | V |

Note 3: Adjust VCC above the start threshold before setting at 10V.

Note 4: Oscillator frequency for the UCCx800, UCCx802 and UCCx803 is the output frequency.

Oscillator frequency for the UCCx801, UCCx804 and UCCx805 is twice the output frequency.

Note 5: Gain is defined by:  $A = \frac{\Delta V_{COMP}}{\Delta V_{CS}}$   $0 \leq V_{CS} \leq 0.8\text{V}$ .

Note 6: Parameter measured at trip point of latch with Pin 2 at 0V.

Note 7: Total Variation includes temperature stability and load regulation.

Note 8: Start Threshold, Stop Threshold and Zener Shunt Thresholds track one another.

Note 9: Guaranteed by design. Not 100% tested in production.

## PIN DESCRIPTIONS

**COMP:** COMP is the output of the error amplifier and the input of the PWM comparator.

Unlike other devices, the error amplifier in the UCC3800 family is a true, low output-impedance, 2MHz operational amplifier. As such, the COMP terminal can both source and sink current. However, the error amplifier is internally current limited, so that you can command zero duty cycle by externally forcing COMP to GND.

The UCC3800 family features built-in full cycle Soft Start. Soft Start is implemented as a clamp on the maximum COMP voltage.

**CS:** CS is the input to the current sense comparators. The UCC3800 family has two different current sense comparators: the PWM comparator and an over-current comparator.

The UCC3800 family contains digital current sense filtering, which disconnects the CS terminal from the current sense comparator during the 100ns interval immediately following the rising edge of the OUT pin. This digital filtering, also called leading-edge blanking, means that in most applications, no analog filtering (RC filter) is required on CS. Compared to an external RC filter technique, the leading-edge blanking provides a smaller

effective CS to OUT propagation delay. Note, however, that the minimum non-zero On-Time of the OUT signal is directly affected by the leading-edge-blanking and the CS to OUT propagation delay.

The over-current comparator is only intended for fault sensing, and exceeding the over-current threshold will cause a soft start cycle.

**FB:** FB is the inverting input of the error amplifier. For best stability, keep FB lead length as short as possible and FB stray capacitance as small as possible.

**GND:** GND is reference ground and power ground for all functions on this part.

**OUT:** OUT is the output of a high-current power driver capable of driving the gate of a power MOSFET with peak currents exceeding  $\pm 750\text{mA}$ . OUT is actively held low when  $V_{CC}$  is below the UVLO threshold.

The high-current power driver consists of FET output devices, which can switch all of the way to GND and all of the way to  $V_{CC}$ . The output stage also provides a very low impedance to overshoot and undershoot. This means that in many cases, external schottky clamp diodes are not required.

**PIN DESCRIPTIONS (cont.)**

**RC:** RC is the oscillator timing pin. For fixed frequency operation, set timing capacitor charging current by connecting a resistor from REF to RC. Set frequency by connecting a timing capacitor from RC to GND. For best performance, keep the timing capacitor lead to GND as short and direct as possible. If possible, use separate ground traces for the timing capacitor and all other functions.

The frequency of oscillation can be estimated with the following equations:

$$\text{UCCx800/1/2/4: } F = \frac{1.5}{R \cdot C}$$

$$\text{UCCx803, UCCx805: } F = \frac{1.0}{R \cdot C}$$

where frequency is in Hz, resistance is in ohms, and capacitance is in farads. The recommended range of timing resistors is between 10k and 200k and timing capacitor is 100pF to 1000pF. Never use a timing resistor less than 10k.

To prevent noise problems, bypass VCC to GND with a ceramic capacitor as close to the VCC pin as possible. An electrolytic capacitor may also be used in addition to the ceramic capacitor.

**REF:** REF is the voltage reference for the error amplifier and also for many other functions on the IC. REF is also

used as the logic power supply for high speed switching logic on the IC.

When V<sub>CC</sub> is greater than 1V and less than the UVLO threshold, REF is pulled to ground through a 5k ohm resistor. This means that REF can be used as a logic output indicating power system status. It is important for reference stability that REF is bypassed to GND with a ceramic capacitor as close to the pin as possible. An electrolytic capacitor may also be used in addition to the ceramic capacitor. A minimum of 0.1µF ceramic is required. Additional REF bypassing is required for external loads greater than 2.5mA on the reference.

To prevent noise problems with high speed switching transients, bypass REF to ground with a ceramic capacitor very close to the IC package.

**VCC:** V<sub>CC</sub> is the power input connection for this device. In normal operation V<sub>CC</sub> is powered through a current limiting resistor. Although quiescent V<sub>CC</sub> current is very low, total supply current will be higher, depending on OUT current. Total V<sub>CC</sub> current is the sum of quiescent V<sub>CC</sub> current and the average OUT current. Knowing the operating frequency and the MOSFET gate charge (Q<sub>g</sub>), average OUT current can be calculated from:

$$I_{OUT} = Q_g \times F.$$

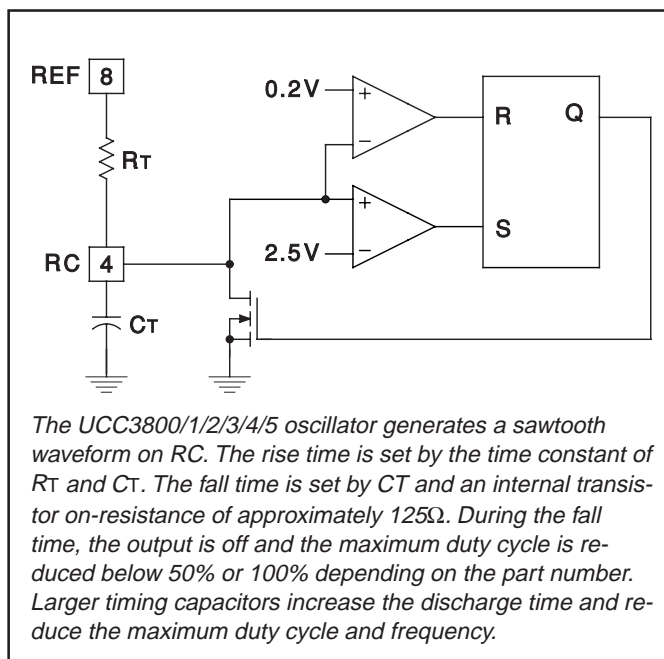

**Figure 1. Oscillator.**

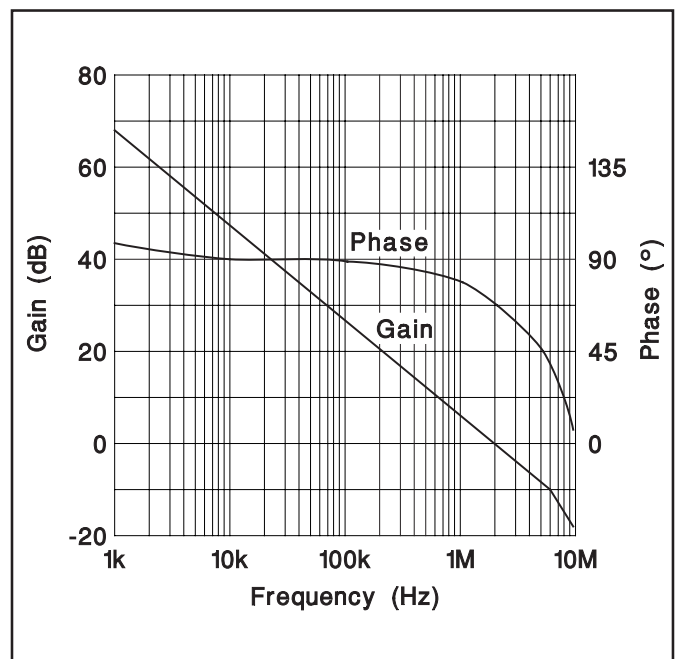

**Figure 2. Error amplifier gain/phase response.**

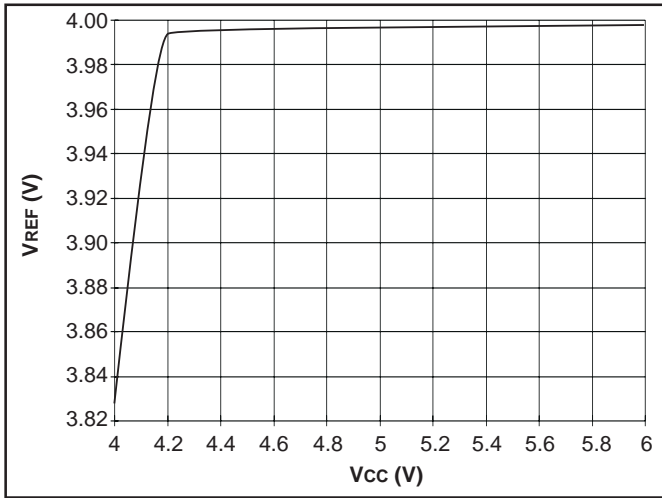

Figure 3. UCC1803/5  $V_{REF}$  vs.  $V_{CC}$ ;  $I_{LOAD} = 0.5mA$ .

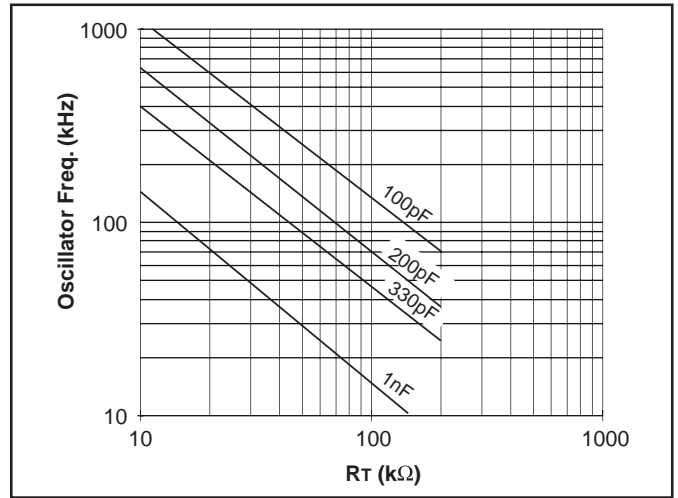

Figure 4. UCC1800/1/2/4 oscillator frequency vs.  $R_T$  and  $C_T$ .

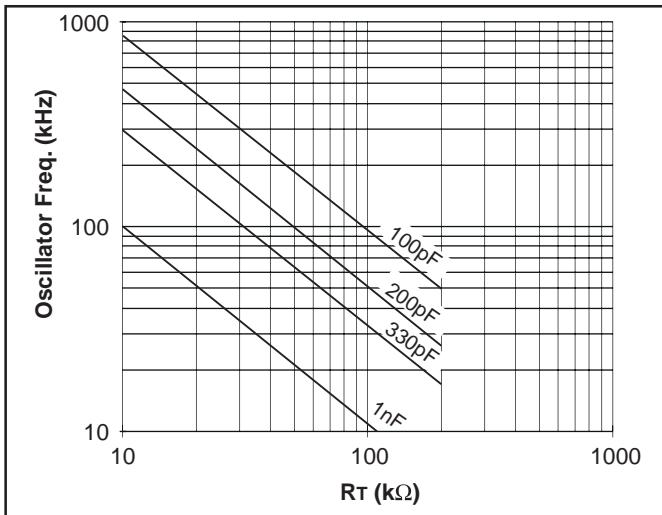

Figure 5. UCC1803/5 oscillator frequency vs.  $R_T$  and  $C_T$ .

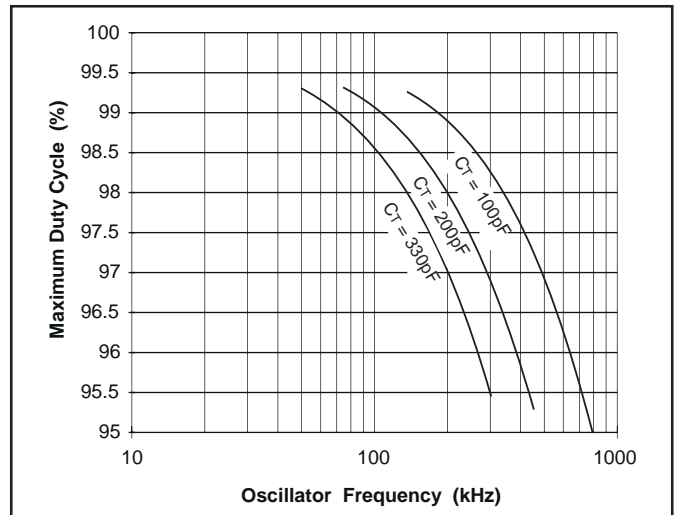

Figure 6. UCC1800/2/3 maximum duty cycle vs. oscillator frequency.

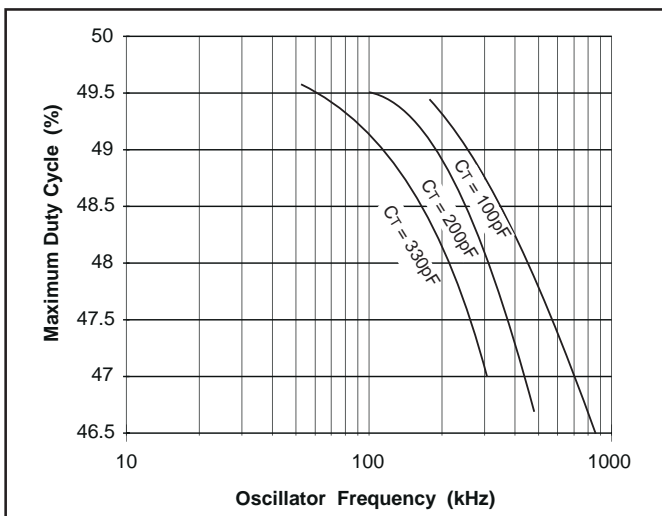

Figure 7. UCC1801/4/5 maximum duty cycle vs. oscillator frequency.

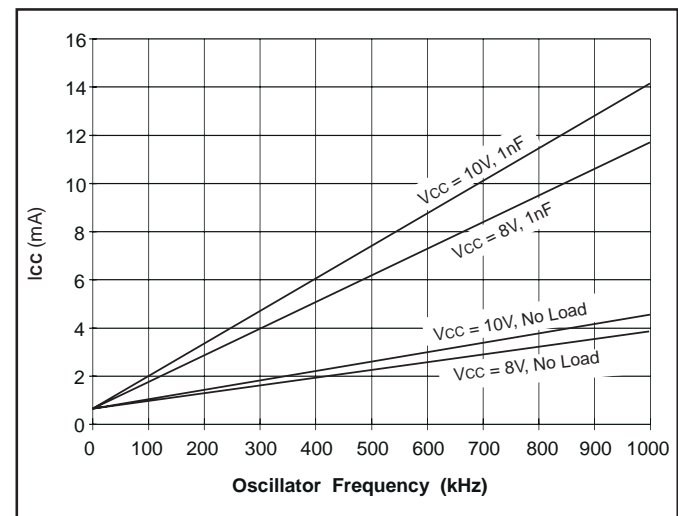

Figure 8. UCC1800  $I_{CC}$  vs. oscillator frequency.

UCC1800/1/2/3/4/5  
 UCC2800/1/2/3/4/5  
 UCC3800/1/2/3/4/5

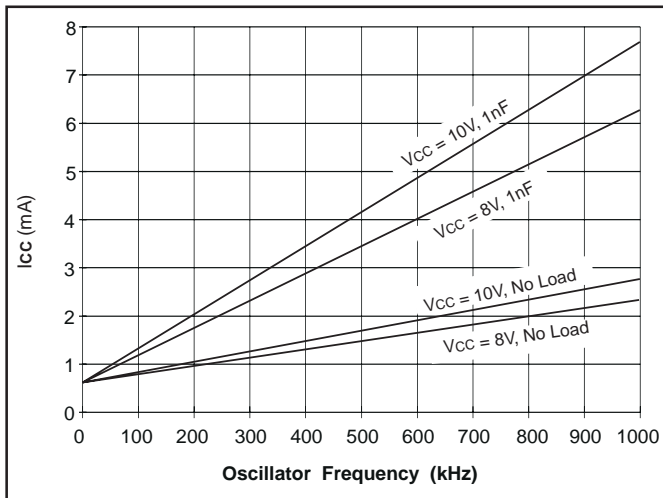

Figure 8. UCC1805 ICC vs. oscillator frequency.

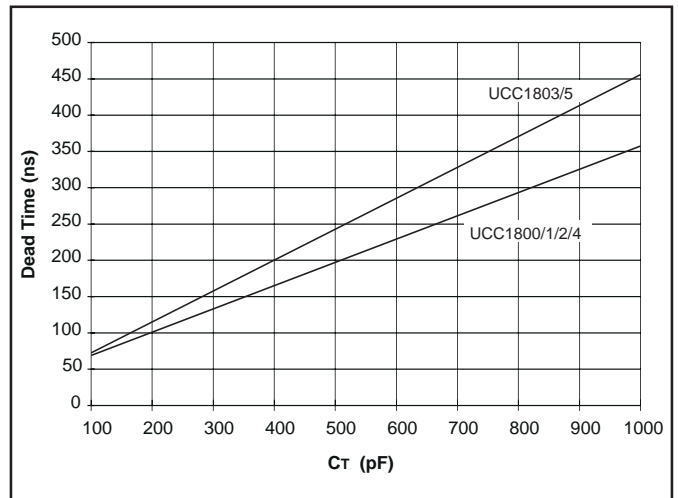

Figure 9. Dead time vs.  $C_T$ ,  $R_T = 100k$ .

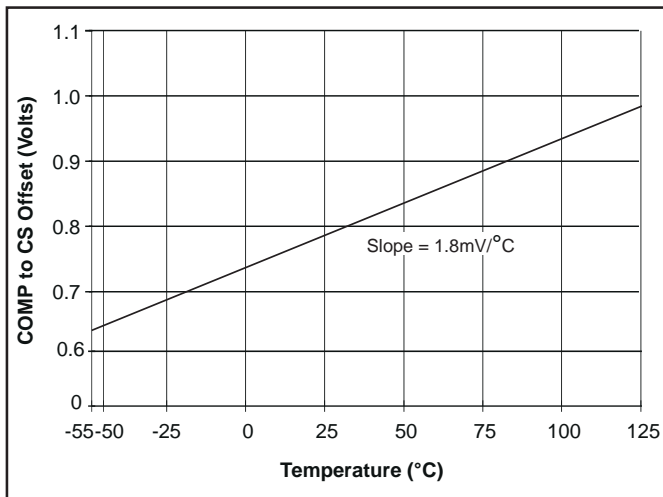

Figure 10. COMP to CS offset vs. temperature, CS = 0V.

## **IMPORTANT NOTICE**

Texas Instruments and its subsidiaries (TI) reserve the right to make changes to their products or to discontinue any product or service without notice, and advise customers to obtain the latest version of relevant information to verify, before placing orders, that information being relied on is current and complete. All products are sold subject to the terms and conditions of sale supplied at the time of order acknowledgement, including those pertaining to warranty, patent infringement, and limitation of liability.

TI warrants performance of its semiconductor products to the specifications applicable at the time of sale in accordance with TI's standard warranty. Testing and other quality control techniques are utilized to the extent TI deems necessary to support this warranty. Specific testing of all parameters of each device is not necessarily performed, except those mandated by government requirements.

CERTAIN APPLICATIONS USING SEMICONDUCTOR PRODUCTS MAY INVOLVE POTENTIAL RISKS OF DEATH, PERSONAL INJURY, OR SEVERE PROPERTY OR ENVIRONMENTAL DAMAGE ("CRITICAL APPLICATIONS"). TI SEMICONDUCTOR PRODUCTS ARE NOT DESIGNED, AUTHORIZED, OR WARRANTED TO BE SUITABLE FOR USE IN LIFE-SUPPORT DEVICES OR SYSTEMS OR OTHER CRITICAL APPLICATIONS. INCLUSION OF TI PRODUCTS IN SUCH APPLICATIONS IS UNDERSTOOD TO BE FULLY AT THE CUSTOMER'S RISK.

In order to minimize risks associated with the customer's applications, adequate design and operating safeguards must be provided by the customer to minimize inherent or procedural hazards.

TI assumes no liability for applications assistance or customer product design. TI does not warrant or represent that any license, either express or implied, is granted under any patent right, copyright, mask work right, or other intellectual property right of TI covering or relating to any combination, machine, or process in which such semiconductor products or services might be or are used. TI's publication of information regarding any third party's products or services does not constitute TI's approval, warranty or endorsement thereof.