

TL7759 SUPPLY-VOLTAGE SUPERVISORS

SLVS042D – JANUARY 1991 – REVISED JULY 1999

- **Power-On Reset Generator**
- **Automatic Reset Generation After Voltage Drop**
- **Precision Input Threshold**
Voltage . . . 4.55 V \pm 120 mV
- **Low Standby Current . . . 20 μ A**
- **Reset Outputs Defined When V_{CC} Exceeds 1 V**
- **True and Complementary Reset Outputs**
- **Wide Supply-Voltage Range . . . 1 V to 7 V**

D, P, OR PW PACKAGE
(TOP VIEW)

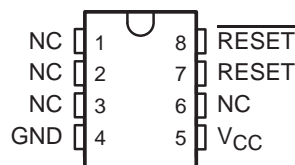

NC – No internal connection

description

The TL7759 is a supply-voltage supervisor designed for use as a reset controller in microcomputer and microprocessor systems. The supervisor monitors the supply voltage for undervoltage conditions. During power up, when the supply voltage, V_{CC} , attains a value approaching 1 V, the RESET and $\overline{\text{RESET}}$ outputs become active (high and low, respectively) to prevent undefined operation. If the supply voltage drops below the input threshold voltage level (V_{IT-}), the reset outputs go to the reset active state until the supply voltage has returned to its nominal value (see timing diagram).

The TL7759C is characterized for operation from 0°C to 70°C.

AVAILABLE OPTIONS

T _A	PACKAGED DEVICES			CHIP FORM (Y)
	SMALL OUTLINE (D)	PLASTIC DIP (P)	SHRINK SMALL OUTLINE (PW)	
0°C to 70°C	TL7759CD	TL7759CP	TL7759CPW	TL7759Y

The D and PW packages are available taped and reeled. Add the suffix R to the device type (e.g., TL7759CDR). Chip forms are tested at 25°C.

functional block diagram

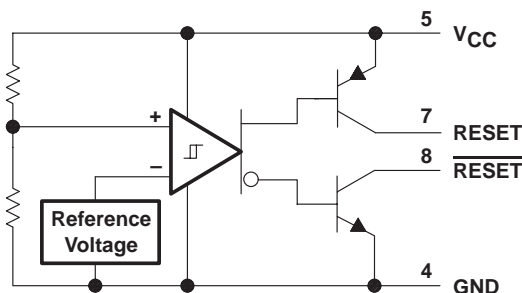

Please be aware that an important notice concerning availability, standard warranty, and use in critical applications of Texas Instruments semiconductor products and disclaimers thereto appears at the end of this data sheet.

PRODUCTION DATA information is current as of publication date. Products conform to specifications per the terms of Texas Instruments standard warranty. Production processing does not necessarily include testing of all parameters.

**TEXAS
INSTRUMENTS**

POST OFFICE BOX 655303 • DALLAS, TEXAS 75265

Copyright © 1999, Texas Instruments Incorporated

TL7759 SUPPLY-VOLTAGE SUPERVISORS

SLVS042D – JANUARY 1991 – REVISED JULY 1999

absolute maximum ratings over operating free-air temperature range (unless otherwise noted)†

Supply voltage, V_{CC} (see Note 1)	20 V
Off-state output voltage range: $\overline{\text{RESET}}$ voltage	-0.3 V to 20 V
RESET voltage	-0.3 V to 20 V
Low-level output current, I_{OL} ($\overline{\text{RESET}}$)	30 mA
High-level output current, I_{OH} (RESET)	-10 mA
Package thermal impedance, θ_{JA} (see Notes 2 and 3): D package	97°C/W
P package	127°C/W
PW package	149°C/W
Lead temperature 1,6 mm (1/16 inch) from case for 10 seconds	260°C
Storage temperature range, T_{stg}	-65°C to 150°C

† Stresses beyond those listed under "absolute maximum ratings" may cause permanent damage to the device. These are stress ratings only, and functional operation of the device at these or any other conditions beyond those indicated under "recommended operating conditions" is not implied. Exposure to absolute-maximum-rated conditions for extended periods may affect device reliability.

- NOTES:
1. All voltage values are with respect to the network ground terminal.
 2. Maximum power dissipation is a function of $T_J(\text{max})$, θ_{JA} , and T_A . The maximum allowable power dissipation at any allowable ambient temperature is $P_D = (T_J(\text{max}) - T_A)/\theta_{JA}$. Operating at the absolute maximum T_J of 150°C can impact reliability.
 3. The package thermal impedance is calculated in accordance with JESD 51, except for through-hole packages, which use a trace length of zero.

recommended operating conditions

		MIN	MAX	UNIT
Supply voltage, V_{CC}		1	7	V
Output voltage, V_O (see Note 4)	Transistor off $\overline{\text{RESET}}$ voltage		15	V
	Transistor off RESET voltage	0		
Low-level output current, I_{OL}	$\overline{\text{RESET}}$		24	mA
High-level output current, I_{OH}	RESET		-8	mA
Operating free-air temperature, T_A	TL7759C	0	70	°C

NOTE 4: RESET output must not be pulled down below GND potential.

electrical characteristics over recommended operating free-air temperature range (unless otherwise noted)

PARAMETER	TEST CONDITIONS	TL7759C			UNIT
		MIN	TYP‡	MAX	
V_{OL} Low-level output voltage	$\overline{\text{RESET}}$ $V_{CC} = 4.3 \text{ V}$ $I_{OL} = 24 \text{ mA}$		0.4	0.8	V
V_{OH} High-level output voltage	RESET $I_{OH} = -8 \text{ mA}$	$V_{CC}-1$			V
V_{IT-} Input threshold voltage (negative-going V_{CC})	$T_A = 25^\circ\text{C}$	4.43	4.55	4.67	V
	$T_A = 0^\circ\text{C to } 70^\circ\text{C}$	4.4		4.7	
$V_{res}\text{§}$ Power-up reset voltage	$R_L = 2.2 \text{ k}\Omega$ $T_A = 25^\circ\text{C}$		0.8	1	V
	$T_A = 0^\circ\text{C to } 70^\circ\text{C}$			1.2	
$V_{hys}\text{¶}$ Hysteresis at V_{CC} input	$T_A = 25^\circ\text{C}$	40	50	60	mV
	$T_A = 0^\circ\text{C to } 70^\circ\text{C}$	30		70	
I_{OH} High-level output current	$\overline{\text{RESET}}$ $V_{CC} = 7 \text{ V}$, See Figure 1 $V_{OH} = 15 \text{ V}$			1	μA
I_{OL} Low-level output current	RESET $V_{OL} = 0 \text{ V}$			-1	μA
I_{CC} Supply current	No load $V_{CC} = 4.3 \text{ V}$		1400	2000	μA
		$V_{CC} = 5.5 \text{ V}$		40	

‡ Typical values are at $T_A = 25^\circ\text{C}$.

§ This is the lowest voltage at which $\overline{\text{RESET}}$ becomes active, V_{CC} slew rate $\leq 5 \text{ V}/\mu\text{s}$.

¶ This is the difference between positive-going input threshold voltage, V_{IT+} , and negative-going input threshold voltage, V_{IT-} .



POST OFFICE BOX 655303 • DALLAS, TEXAS 75265

TL7759 SUPPLY-VOLTAGE SUPERVISORS

SLVS042D – JANUARY 1991 – REVISED JULY 1999

electrical characteristics, $T_A = 25^\circ\text{C}$ (unless otherwise noted)

PARAMETER		TEST CONDITIONS	TL7759Y			UNIT
			MIN	TYP	MAX	
V_{OL}	Low-level output voltage	$\overline{\text{RESET}}$	$V_{CC} = 4.3\text{ V}, I_{OL} = 24\text{ mA}$		0.4	V
V_{IT-}	Input threshold voltage (negative-going V_{CC})				4.55	V
V_{res}^\dagger	Power-up reset voltage	$R_L = 2.2\text{ k}\Omega$			0.8	V
V_{hys}^\ddagger	Hysteresis at V_{CC} input				50	mV
I_{CC}	Supply current	$V_{CC} = 4.3\text{ V},$ No load			1400	μA

† This is the lowest voltage at which $\overline{\text{RESET}}$ becomes active, V_{CC} slew rate $\leq 5\text{ V}/\mu\text{s}$.

‡ This is the difference between positive-going input threshold voltage, V_{IT+} , and negative-going input threshold voltage, V_{IT-} .

timing diagram

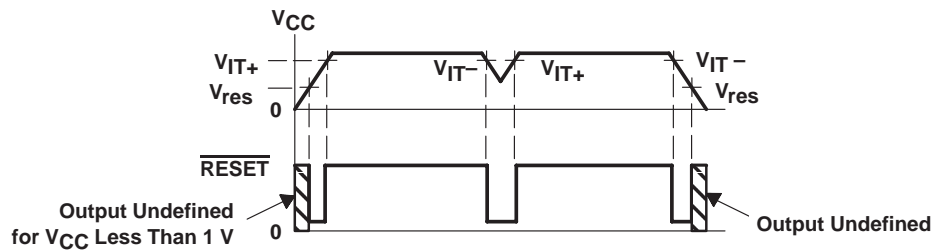

switching characteristics at $T_A = 25^\circ\text{C}$ (unless otherwise noted)

PARAMETER	FROM (INPUT)	TO (OUTPUT)	TEST CONDITIONS	TL7759C		UNIT
				MIN	MAX	
t_{PLH}	Propagation delay time, low-to high-level output	V_{CC}	RESET	See Figures 2 and 3 §	5	μs
t_{PHL}	Propagation delay time, high-to low-level output	V_{CC}	$\overline{\text{RESET}}$	See Figures 2 and 4	5	μs
t_r	Rise time		$\overline{\text{RESET}}$	See Figures 2 and 4 §	1	μs
t_f	Fall time		$\overline{\text{RESET}}$	See Figures 2 and 4	1	μs
$t_{w(\text{min})}$	Minimum pulse duration	V_{CC}	$\overline{\text{RESET}}$	See Figures 2 and 4	5	μs

§ V_{CC} slew rate $\leq 5\text{ V}/\mu\text{s}$



TL7759 SUPPLY-VOLTAGE SUPERVISORS

SLVS042D – JANUARY 1991 – REVISED JULY 1999

PARAMETER MEASUREMENT INFORMATION

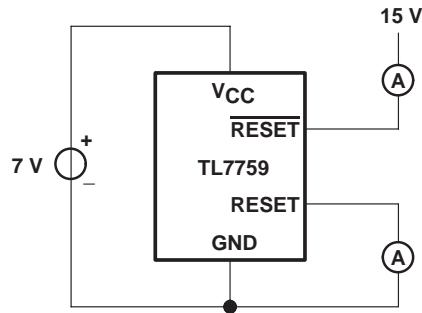
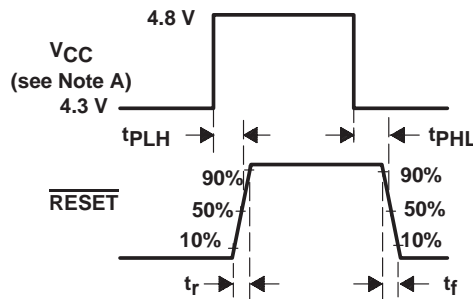
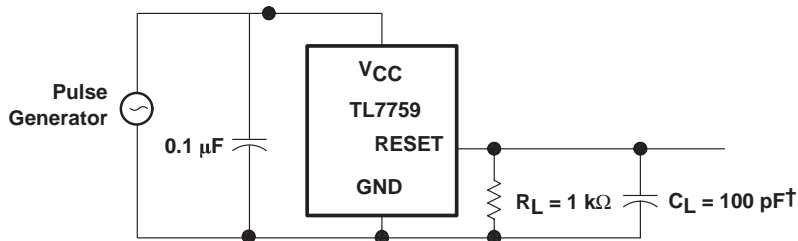

Figure 1. Test Circuit for Output Leakage Current



NOTE A: V_{CC} slew rate $\leq 5V/\mu s$.

Figure 2. Switching Diagram



† C_L Includes jig and probe capacitance.

Figure 3. Test Circuit for RESET Output Switching Characteristics

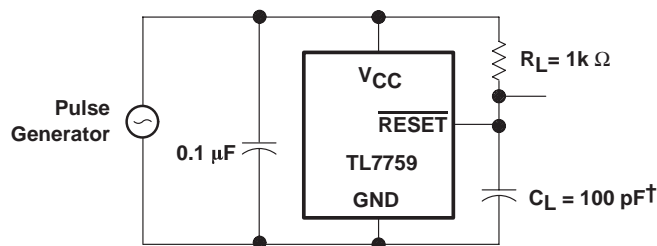

† C_L Includes jig and probe capacitance.

Figure 4. Test Circuit for $\overline{\text{RESET}}$ Output Switching Characteristics

APPLICATION INFORMATION

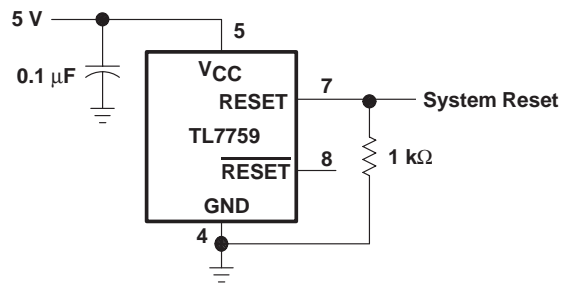

Figure 5. Power-Supply System Reset Generation

IMPORTANT NOTICE

Texas Instruments and its subsidiaries (TI) reserve the right to make changes to their products or to discontinue any product or service without notice, and advise customers to obtain the latest version of relevant information to verify, before placing orders, that information being relied on is current and complete. All products are sold subject to the terms and conditions of sale supplied at the time of order acknowledgement, including those pertaining to warranty, patent infringement, and limitation of liability.

TI warrants performance of its semiconductor products to the specifications applicable at the time of sale in accordance with TI's standard warranty. Testing and other quality control techniques are utilized to the extent TI deems necessary to support this warranty. Specific testing of all parameters of each device is not necessarily performed, except those mandated by government requirements.

CERTAIN APPLICATIONS USING SEMICONDUCTOR PRODUCTS MAY INVOLVE POTENTIAL RISKS OF DEATH, PERSONAL INJURY, OR SEVERE PROPERTY OR ENVIRONMENTAL DAMAGE ("CRITICAL APPLICATIONS"). TI SEMICONDUCTOR PRODUCTS ARE NOT DESIGNED, AUTHORIZED, OR WARRANTED TO BE SUITABLE FOR USE IN LIFE-SUPPORT DEVICES OR SYSTEMS OR OTHER CRITICAL APPLICATIONS. INCLUSION OF TI PRODUCTS IN SUCH APPLICATIONS IS UNDERSTOOD TO BE FULLY AT THE CUSTOMER'S RISK.

In order to minimize risks associated with the customer's applications, adequate design and operating safeguards must be provided by the customer to minimize inherent or procedural hazards.

TI assumes no liability for applications assistance or customer product design. TI does not warrant or represent that any license, either express or implied, is granted under any patent right, copyright, mask work right, or other intellectual property right of TI covering or relating to any combination, machine, or process in which such semiconductor products or services might be or are used. TI's publication of information regarding any third party's products or services does not constitute TI's approval, warranty or endorsement thereof.