

SN74ABT3613 64 × 36 CLOCKED FIRST-IN, FIRST-OUT MEMORY WITH BUS MATCHING AND BYTE SWAPPING

SCBS128F – JULY 1992 – REVISED APRIL 1998

- Low-Power Advanced BiCMOS Technology
- Free-Running CLKA and CLKB Can Be Asynchronous or Coincident
- 64 × 36 FIFO Buffering Data From Port A to Port B
- Mailbox-Bypass Registers in Each Direction
- Dynamic Port-B Bus Sizing of 36 Bits (Long Word), 18 Bits (Word), and 9 Bits (Byte)
- Selection of Big- or Little-Endian Format for Word and Byte Bus Sizes
- Three Modes of Byte-Order Swapping on Port B
- Programmable Almost-Full and Almost-Empty Flags
- Microprocessor Interface Control Logic
- \overline{FF} and \overline{AF} Flags Synchronized by CLKA
- \overline{EF} and \overline{AE} Flags Synchronized by CLKB
- Passive Parity Checking on Each Port
- Parity Generation Can Be Selected for Each Port
- Supports Clock Frequencies up to 67 MHz
- Fast Access Times of 10 ns
- Package Options Include 120-Pin Thin Quad Flat (PCB) and 132-Pin Quad Flat (PQ) Packages

description

The SN74ABT3613 is a high-speed, low-power BiCMOS clocked FIFO memory. It supports clock frequencies up to 67 MHz and has read-access times as fast as 10 ns. A 64 × 36 dual-port SRAM FIFO in this device buffers data from port A to port B. The FIFO has flags to indicate empty and full conditions and two programmable flags (almost full and almost empty) to indicate when a selected number of words is stored in memory. FIFO data on port B can be output in 36-bit, 18-bit, and 9-bit formats, with a choice of big- or little-endian configurations. Three modes of byte-order swapping are possible with any bus-size selection. Communication between each port can bypass the FIFO via two 36-bit mailbox registers. Each mailbox register has a flag to signal when new mail has been stored. Parity is checked passively on each port and can be ignored if not desired. Parity generation can be selected for data read from each port.

The SN74ABT3613 is a clocked FIFO, which means each port employs a synchronous interface. All data transfers through a port are gated to the low-to-high transition of a continuous (free-running) port clock by enable signals. The continuous clocks for each port are independent of one another and can be asynchronous or coincident. The enables for each port are arranged to provide a simple interface between microprocessors and/or buses controlled by a synchronous interface.

The full flag (\overline{FF}) and almost-full (\overline{AF}) flag of a FIFO are two-stage synchronized to the port clock that writes data to its array. The empty flag (\overline{EF}) and almost-empty (\overline{AE}) flag of a FIFO are two-stage synchronized to the port clock that reads data from its array.

The SN74ABT3613 is characterized for operation from 0°C to 70°C.

For more information on this device family, see the following application reports:

- *FIFO Mailbox-Bypass Registers: Using Bypass Registers to Initialize DMA Control* (literature number SCAA007)
- *Advanced Bus-Matching/Byte-Swapping Features for Internetworking FIFO Applications* (literature number SCAA014)
- *Parity-Generate and Parity-Check Features for High-Bandwidth-Computing FIFO Applications* (literature number SCAA015)
- *Internetworking the SN74ABT3613* (literature number SCAA018)
- *Metastability Performance of Clocked FIFOs* (literature number SCZA004)



Please be aware that an important notice concerning availability, standard warranty, and use in critical applications of Texas Instruments semiconductor products and disclaimers thereto appears at the end of this data sheet.

PRODUCTION DATA information is current as of publication date. Products conform to specifications per the terms of Texas Instruments standard warranty. Production processing does not necessarily include testing of all parameters.

 **TEXAS
INSTRUMENTS**

POST OFFICE BOX 655303 • DALLAS, TEXAS 75265

Copyright © 1998, Texas Instruments Incorporated

SN74ABT3613

64 × 36 CLOCKED FIRST-IN, FIRST-OUT MEMORY WITH BUS MATCHING AND BYTE SWAPPING

SCBS128F – JULY 1992 – REVISED APRIL 1998

PCB PACKAGE (TOP VIEW)

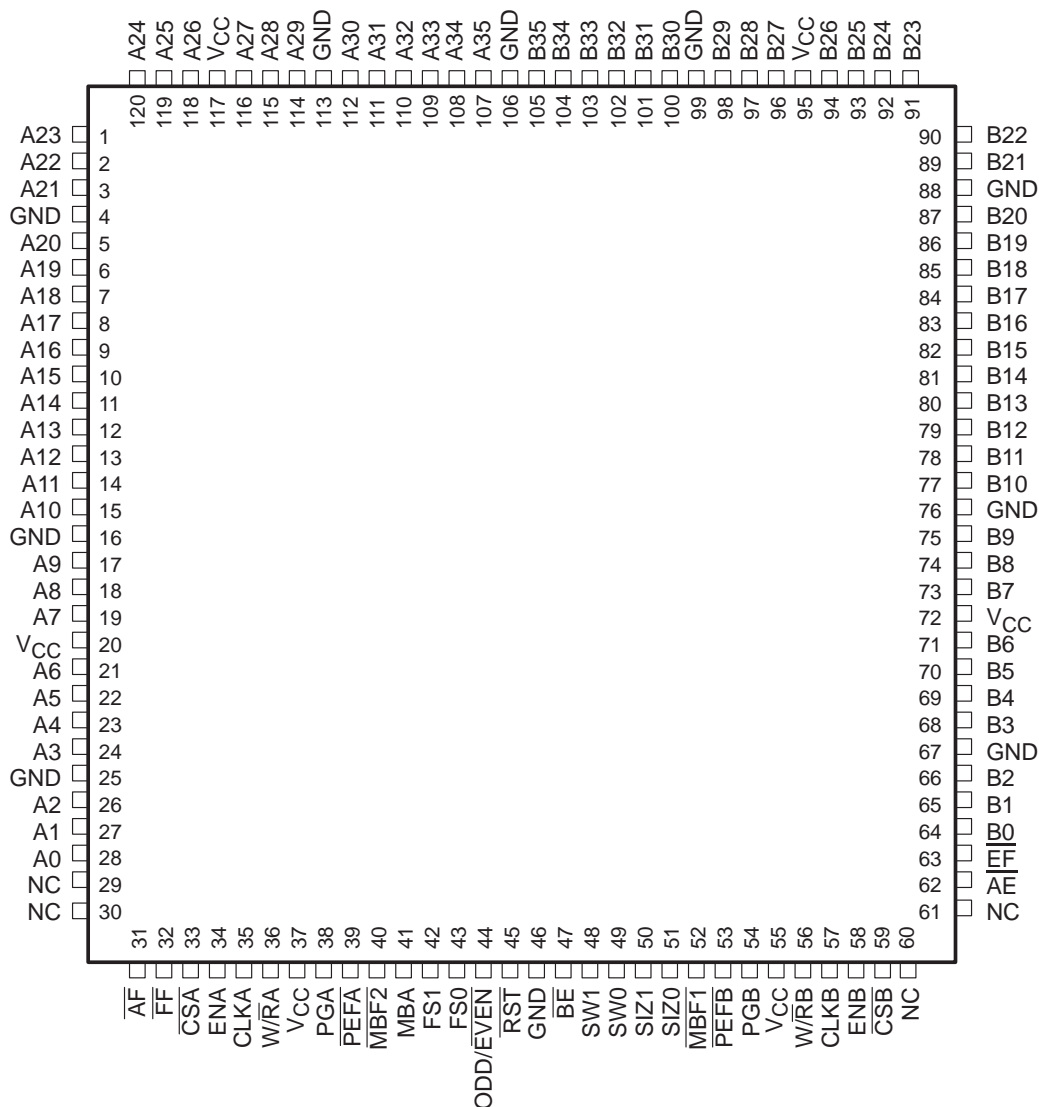

NC – No internal connection

SN74ABT3613

64 × 36 CLOCKED FIRST-IN, FIRST-OUT MEMORY WITH BUS MATCHING AND BYTE SWAPPING

SCBS128F – JULY 1992 – REVISED APRIL 1998

PQ PACKAGE†
(TOP VIEW)

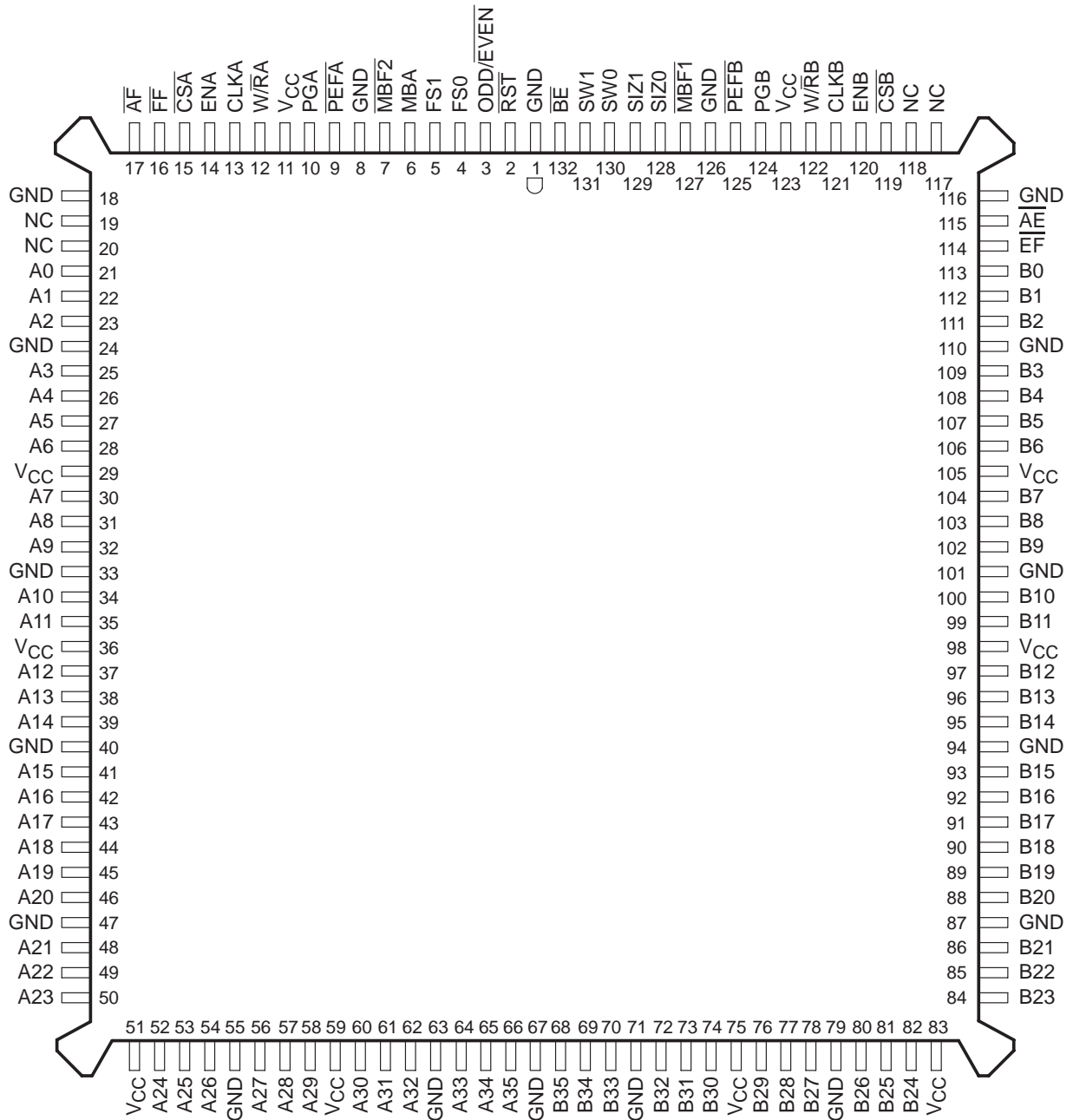

NC – No internal connection
† Uses Yamaichi socket IC51-1324-828

SN74ABT3613
64 × 36 CLOCKED FIRST-IN, FIRST-OUT MEMORY
WITH BUS MATCHING AND BYTE SWAPPING

SCBS128F – JULY 1992 – REVISED APRIL 1998

functional block diagram

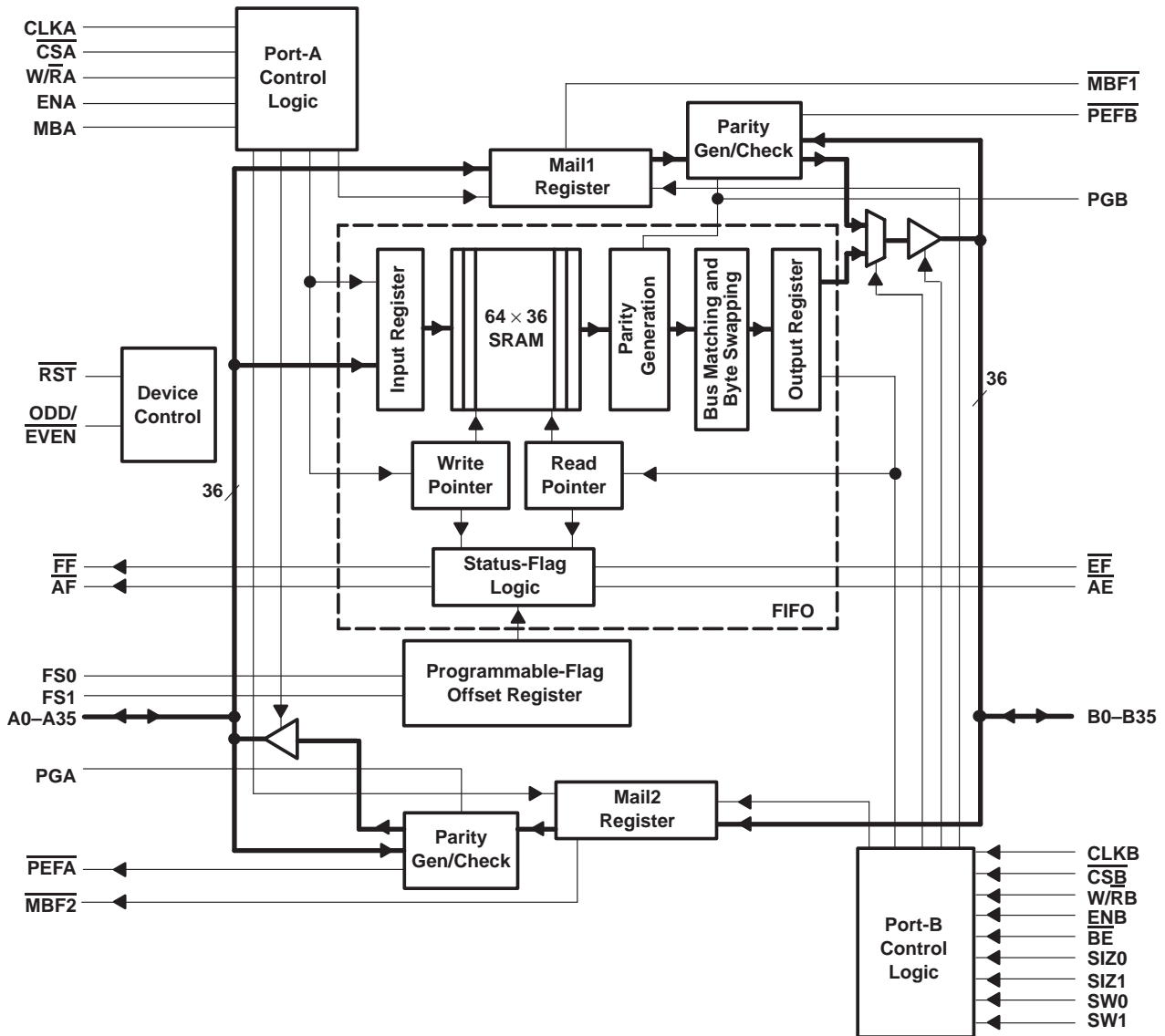

SN74ABT3613
**64 × 36 CLOCKED FIRST-IN, FIRST-OUT MEMORY
 WITH BUS MATCHING AND BYTE SWAPPING**
 SCBS128F – JULY 1992 – REVISED APRIL 1998

Terminal Functions

| TERMINAL NAME | I/O | DESCRIPTION |
|------------------------|---------------|---|
| A0–A35 | I/O | Port-A data. The 36-bit bidirectional data port for side A. |
| \overline{AE} | O (port B) | Almost-empty flag. Programmable almost-empty flag synchronized to CLKB. \overline{AE} is low when the number of 36-bit words in the FIFO is less than or equal to the value in offset register X. |
| \overline{AF} | O (port A) | Almost-full flag. Programmable almost-full flag synchronized to CLKA. \overline{AF} is low when the number of 36-bit empty locations in the FIFO is less than or equal to the value in offset register X. |
| B0–B35 | I/O | Port-B data. The 36-bit bidirectional data port for side B. |
| \overline{BE} | I | Big-endian select. Selects the bytes on port B used during byte or word FIFO reads. A low on \overline{BE} selects the most-significant bytes on B0–B35 for use, and a high selects the least-significant bytes. |
| CLKA | I | Port-A clock. CLKA is a continuous clock that synchronizes all data transfers through port A and can be asynchronous or coincident to CLKB. \overline{FF} and \overline{AF} are synchronized to the low-to-high transition of CLKA. |
| CLKB | I | Port-B clock. CLKB is a continuous clock that synchronizes all data transfers through port B and can be asynchronous or coincident to CLKA. Port-B byte swapping and data-port-sizing operations are also synchronous to the low-to-high transition of CLKB. \overline{EF} and \overline{AE} are synchronized to the low-to-high transition of CLKB. |
| \overline{CSA} | I | Port-A chip select. \overline{CSA} must be low to enable a low-to-high transition of CLKA to read or write data on port A. The A0–A35 outputs are in the high-impedance state when \overline{CSA} is high. |
| \overline{CSB} | I | Port-B chip select. \overline{CSB} must be low to enable a low-to-high transition of CLKB to read or write data on port B. The B0–B35 outputs are in the high-impedance state when \overline{CSB} is high. |
| \overline{EF} | O (port B) | Empty flag. \overline{EF} is synchronized to the low-to-high transition of CLKB. When \overline{EF} is low, the FIFO is empty and reads from its memory are disabled. Data can be read from the FIFO to the output register when \overline{EF} is high. \overline{EF} is forced low when the device is reset and is set high by the second low-to-high transition of CLKB after data is loaded into empty FIFO memory. |
| ENA | I | Port-A enable. ENA must be high to enable a low-to-high transition of CLKA to read or write data on port A. |
| ENB | I | Port-B enable. ENB must be high to enable a low-to-high transition of CLKB to read or write data on port B. |
| \overline{FF} | O (port A) | Full flag. \overline{FF} is synchronized to the low-to-high transition of CLKA. When \overline{FF} is low, the FIFO is full and writes to its memory are disabled. \overline{FF} is forced low when the device is reset and is set high by the second low-to-high transition of CLKA after reset. |
| FS1 FS0 | I | Flag offset selects. The low-to-high transition of \overline{RST} latches the values of FS0 and FS1, which selects one of four preset values for the \overline{AE} flag and \overline{AF} flag offset. |
| MBA | I | Port-A mailbox select. A high level on MBA chooses a mailbox register for a port-A read or write operation. When the A0–A35 outputs are active, mail2 register data is output. |
| $\overline{MBF1}$ | O | Mail1 register flag. $\overline{MBF1}$ is set low by the low-to-high transition of CLKA that writes data to the mail1 register. Writes to the mail1 register are inhibited while $\overline{MBF1}$ is low. $\overline{MBF1}$ is set high by a low-to-high transition of CLKB when a port-B read is selected and both SIZ1 and SIZ0 are high. $\overline{MBF1}$ is set high when the device is reset. |
| $\overline{MBF2}$ | O | Mail2 register flag. $\overline{MBF2}$ is set low by the low-to-high transition of CLKB that writes data to the mail2 register. Writes to the mail2 register are inhibited while $\overline{MBF2}$ is low. $\overline{MBF2}$ is set high by a low-to-high transition of CLKA when a port-A read is selected and MBA is high. $\overline{MBF2}$ is set high when the device is reset. |
| ODD/ \overline{EVEN} | I | Odd/even parity select. Odd parity is checked on each port when ODD/ \overline{EVEN} is high and even parity is checked when ODD/ \overline{EVEN} is low. ODD/ \overline{EVEN} also selects the type of parity generated for each port if parity generation is enabled for a read operation. |
| \overline{PEFA} | O (port A) | Port-A parity error flag. When any byte applied to terminals A0–A35 fails parity, \overline{PEFA} is low. Bytes are organized as A0–A8, A9–A17, A18–A26, and A27–A35, with the most-significant bit of each byte serving as the parity bit. The type of parity checked is determined by the state of ODD/ \overline{EVEN} . The parity trees used to check the A0–A35 inputs are shared by the mail2 register to generate parity if parity generation is selected by PGA; therefore, if a mail2 read with parity generation is set up by having \overline{CSA} low, ENA high, W/RA low, MBA high, and PGA high, the \overline{PEFA} flag is forced high, regardless of the state of the A0–A35 inputs. |

SN74ABT3613
64 × 36 CLOCKED FIRST-IN, FIRST-OUT MEMORY
WITH BUS MATCHING AND BYTE SWAPPING

SCBS128F – JULY 1992 – REVISED APRIL 1998

Terminal Functions (Continued)

| TERMINAL NAME | I/O | DESCRIPTION |
|---------------------------|---------------|---|
| $\overline{\text{PEFB}}$ | O (port B) | Port-B parity error flag. When any valid byte applied to terminals B0–B35 fails parity, $\overline{\text{PEFB}}$ is low. Bytes are organized as B0–B8, B9–B17, B18–B26, and B27–B35 with the most-significant bit of each byte serving as the parity bit. A byte is valid when it is used by the bus size selected for port B. The type of parity checked is determined by the state of ODD/EVEN. The parity trees used to check the B0–B35 inputs are shared by the mail1 register to generate parity if parity generation is selected by PGB; therefore, if a mail1 read with parity generation is set up by having CSB low, ENB high, W/RB low, SIZ1 and SIZ0 high, and PGB high, the $\overline{\text{PEFB}}$ flag is forced high, regardless of the state of the B0–B35 inputs. |
| PGA | I | Port-A parity generation. Parity is generated for data reads from the mail2 register when PGA is high. The type of parity generated is selected by the state of ODD/EVEN. Bytes are organized as A0–A8, A9–A17, A18–A26, and A27–A35. The generated parity bits are output in the most-significant bit of each byte. |
| PGB | I | Port-B parity generation. Parity is generated for data reads from port B when PGB is high. The type of parity generated is selected by the state of ODD/EVEN. Bytes are organized as B0–B8, B9–B17, B18–B26, and B27–B35. The generated parity bits are output in the most-significant bit of each byte. |
| $\overline{\text{RST}}$ | I | Reset. To reset the device, four low-to-high transitions of CLKA and four low-to-high transitions of CLKB must occur while $\overline{\text{RST}}$ is low. This sets the $\overline{\text{AF}}$, $\overline{\text{MBF1}}$, and $\overline{\text{MBF2}}$ flags high and the $\overline{\text{EF}}$, $\overline{\text{AE}}$, and $\overline{\text{FF}}$ flags low. The low-to-high transition of $\overline{\text{RST}}$ latches the status of the FS1 and FS0 inputs to select AF flag and AE flag offset. |
| SIZ0 SIZ1 | I (port B) | Port-B bus size selects. The low-to-high transition of CLKB latches the states of SIZ0, SIZ1, and $\overline{\text{BE}}$, and the following low-to-high transition of CLKB implements the latched states as a port-B bus size. Port-B bus sizes can be long word, word, or byte. A high on both SIZ0 and SIZ1 accesses the mailbox registers for a port-B 36-bit write or read. |
| SW0 SW1 | I (port B) | Port-B byte swap selects. At the beginning of each long-word FIFO read, one of four modes of byte-order swapping is selected by SW0 and SW1. The four modes are no swap, byte swap, word swap, and byte-word swap. Byte-order swapping is possible with any bus-size selection. |
| W/R $\overline{\text{A}}$ | I | Port-A write/read select. W/R $\overline{\text{A}}$ high selects a write operation and a low selects a read operation on port A for a low-to-high transition of CLKA. The A0–A35 outputs are in the high-impedance state when W/R $\overline{\text{A}}$ is high. |
| W/R $\overline{\text{B}}$ | I | Port-B write/read select. W/R $\overline{\text{B}}$ high selects a write operation and a low selects a read operation on port B for a low-to-high transition of CLKB. The B0–B35 outputs are in the high-impedance state when W/R $\overline{\text{B}}$ is high. |

detailed description

reset

The SN74ABT3613 is reset by taking the reset ($\overline{\text{RST}}$) input low for at least four port-A clock (CLKA) and four port-B clock (CLKB) low-to-high transitions. The reset input can switch asynchronously to the clocks. A device reset initializes the internal read and write pointers of each FIFO and forces $\overline{\text{FF}}$ low, $\overline{\text{EF}}$ low, $\overline{\text{AE}}$ low, and the $\overline{\text{AF}}$ high. A reset also forces the mailbox flags ($\overline{\text{MBF1}}$, $\overline{\text{MBF2}}$) high. After a reset, $\overline{\text{FF}}$ is set high after two low-to-high transitions of CLKA. The device must be reset after power up before data is written to its memory.

A low-to-high transition on the $\overline{\text{RST}}$ input loads the $\overline{\text{AF}}$ and $\overline{\text{AE}}$ offset register (X) with the value selected by the flag-select (FS0, FS1) inputs. The values that can be loaded into the register are shown in Table 1.

Table 1. Flag Programming

| FS1 | FS0 | $\overline{\text{RST}}$ | $\overline{\text{AF/AE}}$ FLAG OFFSET REGISTER (X) |
|-----|-----|-------------------------|--|
| H | H | ↑ | 16 |
| H | L | ↑ | 12 |
| L | H | ↑ | 8 |
| L | L | ↑ | 4 |



SN74ABT3613
**64 × 36 CLOCKED FIRST-IN, FIRST-OUT MEMORY
 WITH BUS MATCHING AND BYTE SWAPPING**

SCBS128F – JULY 1992 – REVISED APRIL 1998

FIFO write/read operation

The state of the port-A data (A0–A35) outputs is controlled by the port-A chip select (\overline{CSA}) and the port-A write/read select (W/\overline{RA}). The A0–A35 outputs are in the high-impedance state when either \overline{CSA} or W/\overline{RA} is high. The A0–A35 outputs are active when both \overline{CSA} and W/\overline{RA} are low. Data is loaded into the FIFO from the A0–A35 inputs on a low-to-high transition of $CLKA$ when \overline{CSA} is low, W/\overline{RA} is high, ENA is high, MBA is low, and \overline{FFA} is high (see Table 2).

Table 2. Port-A Enable Function Table

| \overline{CSA} | W/\overline{RA} | ENA | MBA | $CLKA$ | A0–A35 OUTPUTS | PORT FUNCTION |
|------------------|-------------------|-------|-------|--------|-------------------------|---|
| H | X | X | X | X | In high-impedance state | None |
| L | H | L | X | X | In high-impedance state | None |
| L | H | H | L | ↑ | In high-impedance state | FIFO write |
| L | H | H | H | ↑ | In high-impedance state | Mail1 write |
| L | L | L | L | X | Active, mail2 register | None |
| L | L | H | L | ↑ | Active, mail2 register | None |
| L | L | L | H | X | Active, mail2 register | None |
| L | L | H | H | ↑ | Active, mail2 register | Mail2 read (set $\overline{MBF2}$ high) |

The state of the port-B data (B0–B35) outputs is controlled by the port-B chip select (\overline{CSB}) and the port-B write/read select (W/\overline{RB}). The B0–B35 outputs are in the high-impedance state when either \overline{CSB} or W/\overline{RB} is high. The B0–B35 outputs are active when both \overline{CSB} and W/\overline{RB} are low. Data is read from the FIFO to the B0–B35 outputs by a low-to-high transition of $CLKB$ when \overline{CSB} is low, W/\overline{RB} is low, ENB is high, \overline{EFB} is high, and either $SIZ0$ or $SIZ1$ is low (see Table 3).

Table 3. Port-B Enable Function Table

| \overline{CSB} | W/\overline{RB} | ENB | $SIZ1, SIZ0$ | $CLKB$ | B0–B35 OUTPUTS | PORT FUNCTION |
|------------------|-------------------|-------|---------------|--------|------------------------------|---|
| H | X | X | X | X | In high-impedance state | None |
| L | H | L | X | X | In high-impedance state | None |
| L | H | H | One, both low | ↑ | In high-impedance state | None |
| L | H | H | Both high | ↑ | In high-impedance state | Mail2 write |
| L | L | L | One, both low | X | Active, FIFO output register | None |
| L | L | H | One, both low | ↑ | Active, FIFO output register | FIFO read |
| L | L | L | Both high | X | Active, mail1 register | None |
| L | L | H | Both high | ↑ | Active, mail1 register | Mail1 read (set $\overline{MBF1}$ high) |

The setup- and hold-time constraints to the port clocks for the port-chip selects (\overline{CSA} , \overline{CSB}) and write/read selects (W/\overline{RA} , W/\overline{RB}) are only for enabling write and read operations and are not related to high-impedance control of the data outputs. If a port enable is low during a clock cycle, the port chip select and write/read select can change states during the setup- and hold-time window of the cycle.



SN74ABT3613

64 × 36 CLOCKED FIRST-IN, FIRST-OUT MEMORY WITH BUS MATCHING AND BYTE SWAPPING

SCBS128F – JULY 1992 – REVISED APRIL 1998

synchronized FIFO flags

Each FIFO flag is synchronized to its port clock through two flip-flop stages. This is done to improve flag reliability by reducing the probability of metastable events on the output when CLKA and CLKB operate asynchronously to one another. \overline{FF} and \overline{AF} are synchronized to CLKA. \overline{EF} and \overline{AE} are synchronized to CLKB. Table 4 shows the relationship of each port flag to the level of FIFO fill.

Table 4. FIFO Flag Operation

| NUMBER OF 36-BIT WORDS IN THE FIFO† | SYNCHRONIZED TO CLKB | | SYNCHRONIZED TO CLKA | |
|-------------------------------------|----------------------|-----------------|----------------------|-----------------|
| | \overline{EF} | \overline{AE} | \overline{AF} | \overline{FF} |
| 0 | L | L | H | H |
| 1 to X | H | L | H | H |
| (X + 1) to [64 – (X + 1)] | H | H | H | H |
| (64 – X) to 63 | H | H | L | H |
| 64 | H | H | L | L |

† X is the value in the \overline{AE} flag and \overline{AF} flag offset register.

empty flag (\overline{EF})

The FIFO \overline{EF} is synchronized to the port clock that reads data from its array (CLKB). When the empty flag is high, new data can be read to the FIFO output register. When the empty flag is low, the FIFO is empty and attempted FIFO reads are ignored. When reading the FIFO with a byte or word size on port B, \overline{EF} is set low when the fourth byte or second word of the last long word is read.

The FIFO read pointer is incremented each time a new word is clocked to the output register. A word written to the FIFO can be read to the FIFO output register in a minimum of three port-B clock (CLKB) cycles. An \overline{EF} is low if a word in memory is the next data to be sent to the FIFO output register and two cycles of the port clock that reads data from the FIFO have not elapsed since the time the word was written. The FIFO \overline{EF} is set high by the second low-to-high transition of CLKB and the new data word can be read to the FIFO output register in the following cycle.

A low-to-high transition on CLKB begins the first synchronization cycle of a write if the clock transition occurs at time t_{sk1} , or greater, after the write. Otherwise, the subsequent clock cycle can be the first synchronization cycle (see Figure 9).

full flag (\overline{FF})

The FIFO \overline{FF} is synchronized to the port clock that writes data to its array (CLKA). When \overline{FF} is high, a memory location is free in the SRAM to receive new data. No memory locations are free when \overline{FF} is low and attempted writes to the FIFO are ignored.

Each time a word is written to the FIFO, the write pointer is incremented. From the time a word is read from the FIFO, the previous memory location is ready to be written in a minimum of three CLKA cycles. \overline{FF} is low if fewer than two CLKA cycles have elapsed since the next memory-write location has been read. The second low-to-high transition on the \overline{FF} synchronizing clock after the read sets the \overline{FF} high and data can be written in the following clock cycle.

A low-to-high transition on CLKA begins the first synchronization cycle of a read if the clock transition occurs at time t_{sk1} , or greater, after the read. Otherwise, the subsequent clock cycle can be the first synchronization cycle (see Figure 10).

almost-empty flag (\overline{AE})

The FIFO \overline{AE} flag is synchronized to the port clock that reads data from its array (CLKB). The almost-empty state is defined by the value of the \overline{AF} and \overline{AE} offset register (X). This register is loaded with one of four preset values during a device reset (see *reset*). An \overline{AE} flag is low when the FIFO contains X or fewer long words in memory and is high when the FIFO contains (X + 1) or more long words.

Two low-to-high transitions of CLKB are required after a FIFO write for the \overline{AE} flag to reflect the new level of fill; therefore, the \overline{AE} flag of a FIFO containing (X + 1) or more long words remains low if two CLKB cycles have not elapsed since the write that filled the memory to the (X + 1) level. An \overline{AE} flag is set high by the second low-to-high transition of CLKB after the FIFO write that fills memory to the (X + 1) level. A low-to-high transition of CLKB begins the first synchronization cycle if it occurs at time t_{sk2} , or greater, after the write that fills the FIFO to (X + 1) long words. Otherwise, the subsequent CLKB cycle can be the first synchronization cycle (see Figure 11).

almost-full flag (\overline{AF})

The FIFO \overline{AF} flag is synchronized to the port clock that writes data to its array (CLKA). The almost-full state is defined by the value of the \overline{AF} and \overline{AE} offset register (X). This register is loaded with one of four preset values during a device reset (see *reset*). An \overline{AF} flag is low when the FIFO contains (64 – X) or more long words in memory and is high when the FIFO contains [64 – (X + 1)] or less long words.

Two low-to-high transitions of CLKA are required after a FIFO read for the \overline{AF} flag to reflect the new level of fill; therefore, the \overline{AF} flag of a FIFO containing [64 – (X + 1)] or fewer words remains low if two CLKA cycles have not elapsed since the read that reduced the number of long words in memory to [64 – (X + 1)]. An \overline{AF} flag is set high by the second low-to-high transition of CLKA after the FIFO read that reduces the number of long words in memory to [64 – (X + 1)]. A low-to-high transition of CLKA begins the first synchronization cycle if it occurs at time t_{sk2} , or greater, after the read that reduces the number of long words in memory to [64 – (X + 1)]. Otherwise, the subsequent CLKA cycle can be the first synchronization cycle (see Figure 12).

mailbox registers

Two 36-bit bypass registers (mail1, mail2) are on board the SN74ABT3613 to pass command and control information between port A and port B without putting it in queue. A low-to-high transition on CLKA writes A0–A35 data to the mail1 register when a port-A write is selected by \overline{CSA} , W/\overline{RA} , and ENA, and MBA is high. A low-to-high transition on CLKB writes B0–B35 data to the mail2 register when a port-B write is selected by (\overline{CSB} , W/\overline{RB} , and ENB) and both SIZ0 and SIZ1 are high. Writing data to a mail register sets the corresponding flag ($\overline{MBF1}$ or $\overline{MBF2}$) low. Attempted writes to a mail register are ignored while the mail flag is low.

When the port-B data outputs (B0–B35) are active, the data on the bus comes from the FIFO output register when either one or both SIZ1 and SIZ0 are low and from the mail1 register when both SIZ1 and SIZ0 are high. The mail1 register flag ($\overline{MBF1}$) is set high by a rising CLKB edge when a port-B read is selected by \overline{CSB} , W/\overline{RB} , and ENB, and both SIZ1 and SIZ0 are high. The mail2 register flag ($\overline{MBF2}$) is set high by a rising CLKA edge when a port-A read is selected by \overline{CSA} , W/\overline{RA} , and ENA and MBA is high. The data in the mail register remains intact after it is read and changes only when new data is written to the register.

SN74ABT3613
64 × 36 CLOCKED FIRST-IN, FIRST-OUT MEMORY
WITH BUS MATCHING AND BYTE SWAPPING

SCBS128F – JULY 1992 – REVISED APRIL 1998

dynamic bus sizing

The port-B bus can be configured in a 36-bit long word, 18-bit word, or 9-bit byte format for data read from the FIFO. Word- and byte-size bus selections can utilize the most-significant bytes of the bus (big endian) or least-significant bytes of the bus (little endian). Port-B bus size can be changed dynamically and synchronous to CLKB to communicate with peripherals of various bus widths.

The levels applied to the port-B bus-size select (SIZ0, SIZ1) inputs and the big-endian select (\overline{BE}) input are stored on each CLKB low-to-high transition. The stored port-B bus-size selection is implemented by the next rising edge on CLKB according to Figure 1.

Only 36-bit long-word data is written to or read from the FIFO memory on the SN74ABT3613. Bus-matching operations are done after data is read from the FIFO RAM. Port-B bus sizing does not apply to mail-register operations.

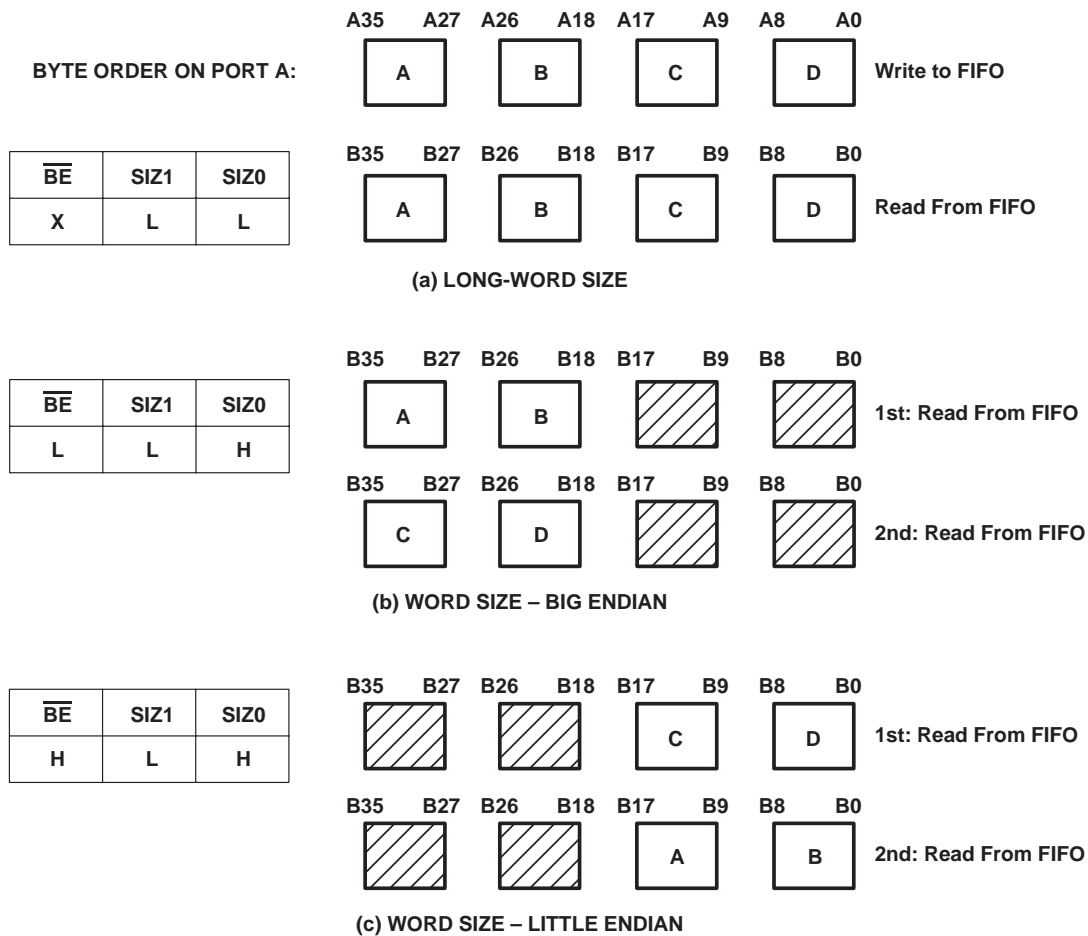

Figure 1. Dynamic Bus Sizing

SN74ABT3613
**64 × 36 CLOCKED FIRST-IN, FIRST-OUT MEMORY
 WITH BUS MATCHING AND BYTE SWAPPING**

SCBS128F – JULY 1992 – REVISED APRIL 1998

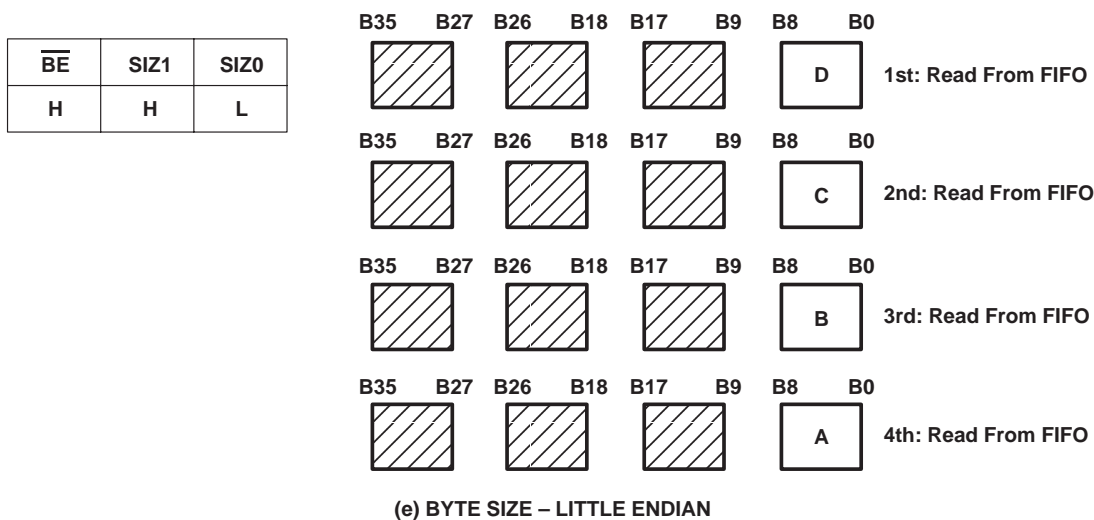
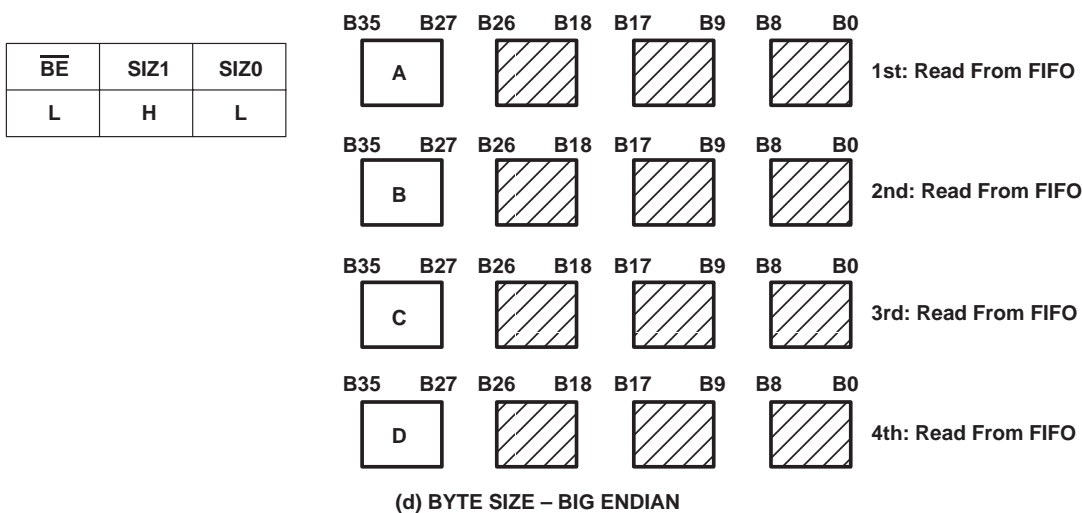

Figure 1. Dynamic Bus Sizing (Continued)

bus-matching FIFO reads

Data is read from the FIFO RAM in 36-bit long-word increments. If a long-word bus size is implemented, the entire long word immediately shifts to the FIFO output register upon a read. If byte or word size is implemented on port B, only the first one or two bytes appear on the selected portion of the FIFO output register with the rest of the long word stored in auxiliary registers. In this case, subsequent FIFO reads with the same bus-size implementation output the rest of the long word to the FIFO output register in the order shown by Figure 1.

Each FIFO read with a new bus-size implementation automatically unloads data from the FIFO RAM to its output register and auxiliary registers. Implementing a new port-B bus size and performing a FIFO read before all bytes or words stored in the auxiliary registers have been read results in a loss of the unread data in these registers.

When reading data from FIFO in byte or word format, the unused B0–B35 outputs remain inactive but static, with the unused FIFO output register bits holding the last data value to decrease power consumption.

SN74ABT3613

64 × 36 CLOCKED FIRST-IN, FIRST-OUT MEMORY WITH BUS MATCHING AND BYTE SWAPPING

SCBS128F – JULY 1992 – REVISED APRIL 1998

port-B mail-register access

In addition to selecting port-B bus sizes for FIFO reads, the port-B bus-size select (SIZ0, SIZ1) inputs also access the mail registers. When both SIZ0 and SIZ1 are high, the mail1 register is accessed for a port-B long-word read and the mail2 register is accessed for a port-B long-word write. The mail register is accessed immediately. Any bus-sizing operation that is underway is unaffected by the mail-register access. After the mail-register access is complete, the previous FIFO access can resume in the next CLKB cycle. The logic diagram in Figure 2 shows the previous bus-size selection is preserved when the mail registers are accessed from port B. A port-B bus size is implemented on each rising CLKB edge according to the states of SIZ0_Q, SIZ1_Q, and $\overline{\text{BE}}_Q$.

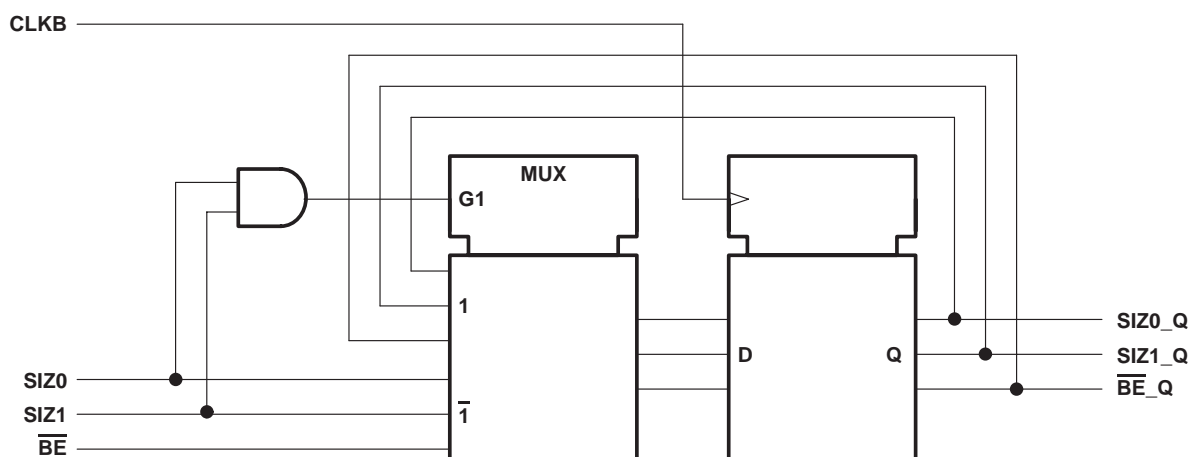

Figure 2. Logic Diagram for SIZ0, SIZ1, and $\overline{\text{BE}}$ Register

byte swapping

The byte-order arrangement of data read from the FIFO can be changed synchronous to the rising edge of CLKB. Byte-order swapping is not available for mail-register data. Four modes of byte-order swapping (including no swap) can be done with any data-port-size selection. The order of the bytes is rearranged within the long word, but the bit order within the bytes remains constant.

Byte arrangement is chosen by the port-B swap-select (SW0, SW1) inputs on a CLKB rising edge that reads a new long word from the FIFO. The byte order chosen on the first byte or first word of a new long-word read from the FIFO is maintained until the entire long word is transferred, regardless of the SW0 and SW1 states during subsequent reads. Figure 3 is an example of the byte-order swapping available for long-word reads. Performing a byte swap and bus size simultaneously for a FIFO read rearranges the bytes as shown in Figure 3, then outputs the bytes as shown in Figure 1.

SN74ABT3613
**64 × 36 CLOCKED FIRST-IN, FIRST-OUT MEMORY
 WITH BUS MATCHING AND BYTE SWAPPING**

SCBS128F – JULY 1992 – REVISED APRIL 1998

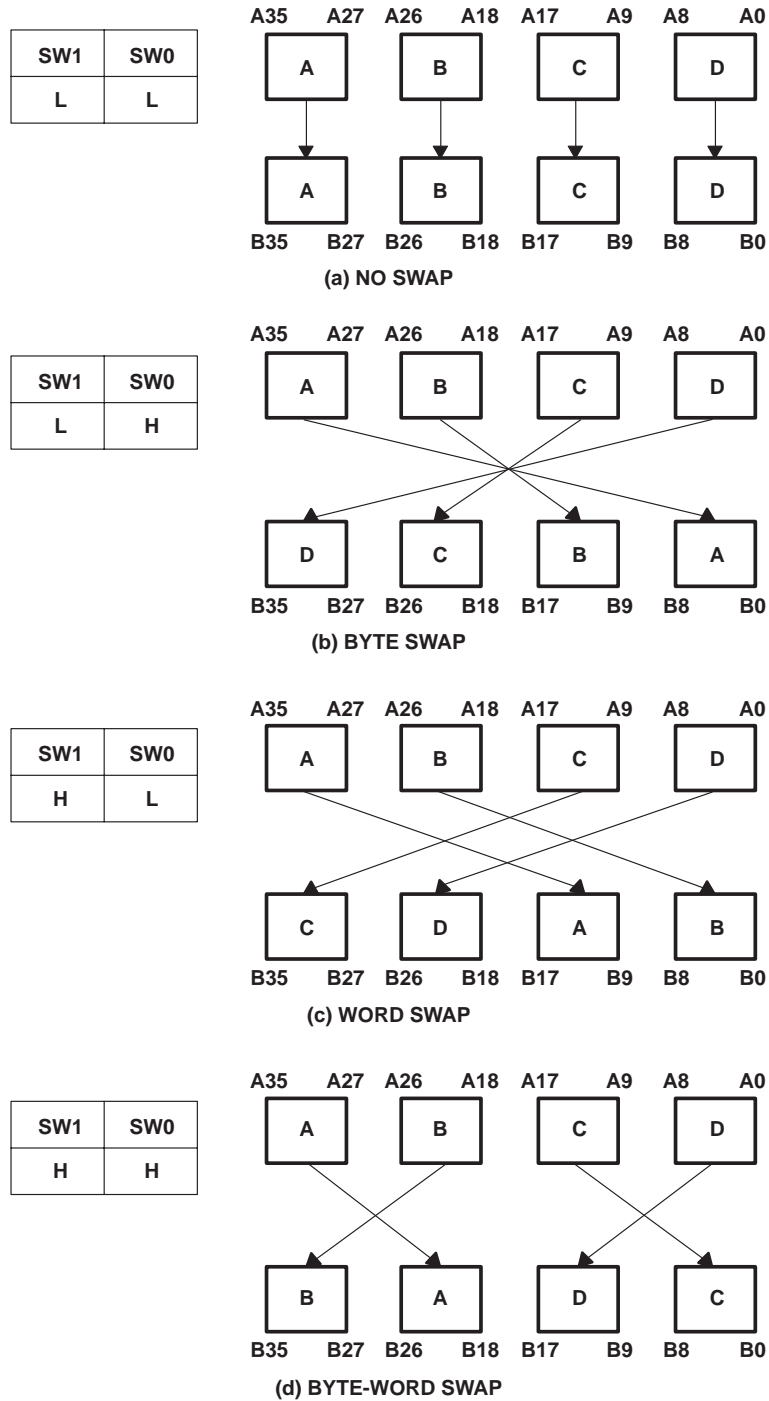

Figure 3. Byte Swapping for FIFO Reads (Long-Word Size Example)

SN74ABT3613

64 × 36 CLOCKED FIRST-IN, FIRST-OUT MEMORY WITH BUS MATCHING AND BYTE SWAPPING

SCBS128F – JULY 1992 – REVISED APRIL 1998

parity checking

The port-A data inputs (A0–A35) and port-B data inputs (B0–B35) each have four parity trees to check the parity of incoming (or outgoing) data. A parity failure on one or more bytes of the port-A data bus is reported by a low level on the port-A parity error flag ($\overline{\text{PEFA}}$). A parity failure on one or more bytes of the port-B data inputs that are valid for the bus-size implementation is reported by a low level on the port-B parity-error flag ($\overline{\text{PEFB}}$). Odd or even parity checking can be selected and the parity-error flags can be ignored if this feature is not desired.

Parity status is checked on each input bus according to the level of the odd/even parity ($\text{ODD}/\overline{\text{EVEN}}$) select input. A parity error on one or more valid bytes of a port is reported by a low level on the corresponding port parity-error flag ($\overline{\text{PEFA}}$, $\overline{\text{PEFB}}$) output. Port-A bytes are arranged as A0–A8, A9–A17, A18–A26, and A27–A35. Port-B bytes are arranged as B0–B8, B9–B17, B18–B26, and B27–B35, and its valid bytes are those used in a port-B bus-size implementation. When odd/even parity is selected, a port parity-error flag ($\overline{\text{PEFA}}$, $\overline{\text{PEFB}}$) is low if any valid byte on the port has an odd/even number of low levels applied to the bits.

The four parity trees used to check the A0–A35 inputs are shared by the mail2 register when parity generation is selected for port-A reads ($\text{PGA} = \text{high}$). When a port-A read from the mail2 register with parity generation is selected with $\overline{\text{CSA}}$ low, ENA high, $\text{W}/\overline{\text{RA}}$ low, MBA high, and PGA high, $\overline{\text{PEFA}}$ is held high, regardless of the levels applied to the A0–A35 inputs. Likewise, the parity trees used to check the B0–B35 inputs are shared by the mail1 register when parity generation is selected for port-B reads ($\text{PGB} = \text{high}$). When a port-B read from the mail1 register with parity generation is selected with $\overline{\text{CSB}}$ low, ENB high, $\text{W}/\overline{\text{RB}}$ low, both SIZ0 and SIZ1 high, and PGB high, $\overline{\text{PEFB}}$ is held high, regardless of the levels applied to the B0–B35 inputs.

parity generation

A high level on the port-A parity-generate select (PGA) or port-B parity-generate select (PGB) enables the SN74ABT3613 to generate parity bits for port reads from a FIFO or mailbox register. Port-A bytes are arranged as A0–A8, A9–A17, A18–A26, and A27–A35, with the most-significant bit of each byte used as the parity bit. Port-B bytes are arranged as B0–B8, B9–B17, B18–B26, and B27–B35 with the most-significant bit of each byte used as the parity bit. A write to a FIFO or mail register stores the levels applied to all nine inputs of a byte, regardless of the state of the parity-generate select (PGA , PGB) inputs. When data is read from a port with parity generation selected, the lower eight bits of each byte are used to generate a parity bit according to the level on the $\text{ODD}/\overline{\text{EVEN}}$ select. The generated parity bits are substituted for the levels originally written to the most-significant bits of each byte as the word is read to the data outputs.

Parity bits for FIFO data are generated after the data is read from SRAM and before the data is written to the output register. The port-A parity-generate select (PGA) and odd/even parity select ($\text{ODD}/\overline{\text{EVEN}}$) have setup- and hold-time constraints to the port-A clock (CLKA) and the port-B parity-generate select (PGB) and $\text{ODD}/\overline{\text{EVEN}}$ select have setup- and hold-time constraints to the port-B clock (CLKB). These timing constraints apply only for a rising clock edge used to read a new long word to the FIFO output register.

The circuit used to generate parity for the mail1 data is shared by the port-B bus (B0–B35) to check parity. The circuit used to generate parity for the mail2 data is shared by the port-A bus (A0–A35) to check parity. The shared parity trees of a port are used to generate parity bits for the data in a mail register when the port-chip select ($\overline{\text{CSA}}$, $\overline{\text{CSB}}$) is low, enable (ENA , ENB) is high, and write/read select ($\text{W}/\overline{\text{RA}}$, $\text{W}/\overline{\text{RB}}$) input is low, the mail register is selected (MBA is high for port A; both SIZ0 and SIZ1 are high for port B), and port parity-generate select (PGA , PGB) is high. Generating parity for mail-register data does not change the contents of the register.

SN74ABT3613
**64 × 36 CLOCKED FIRST-IN, FIRST-OUT MEMORY
 WITH BUS MATCHING AND BYTE SWAPPING**

SCBS128F – JULY 1992 – REVISED APRIL 1998

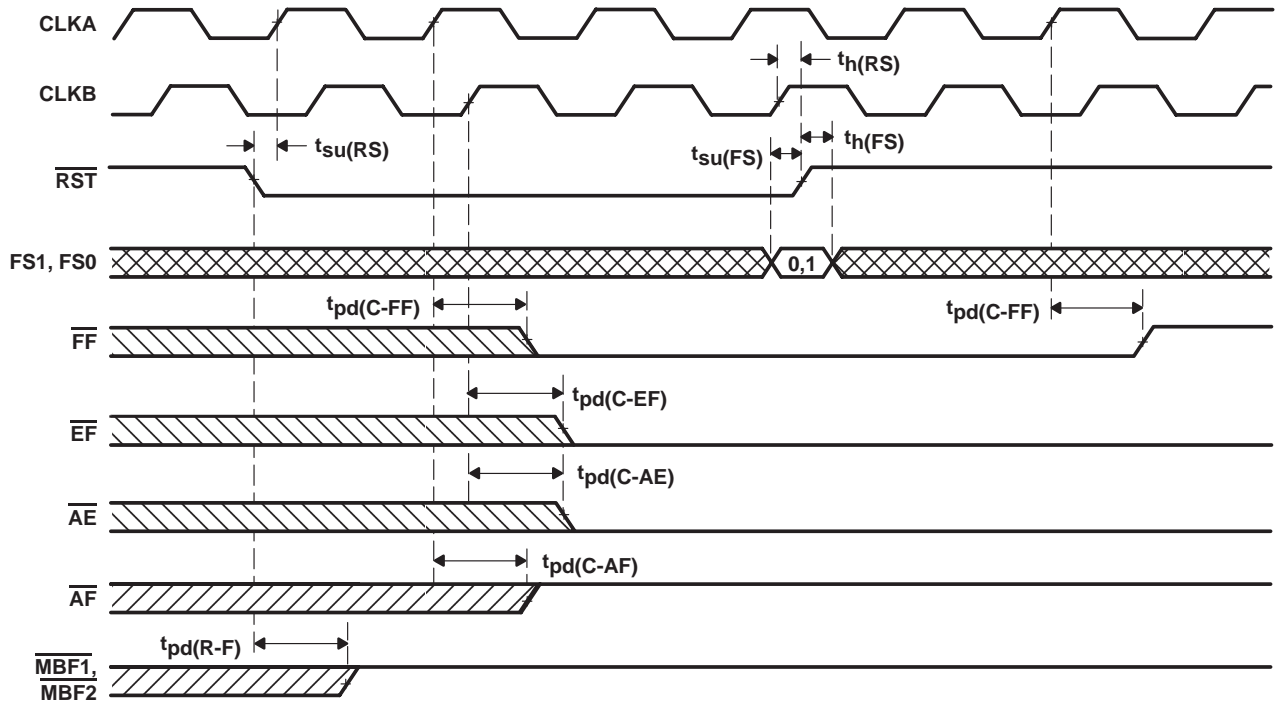
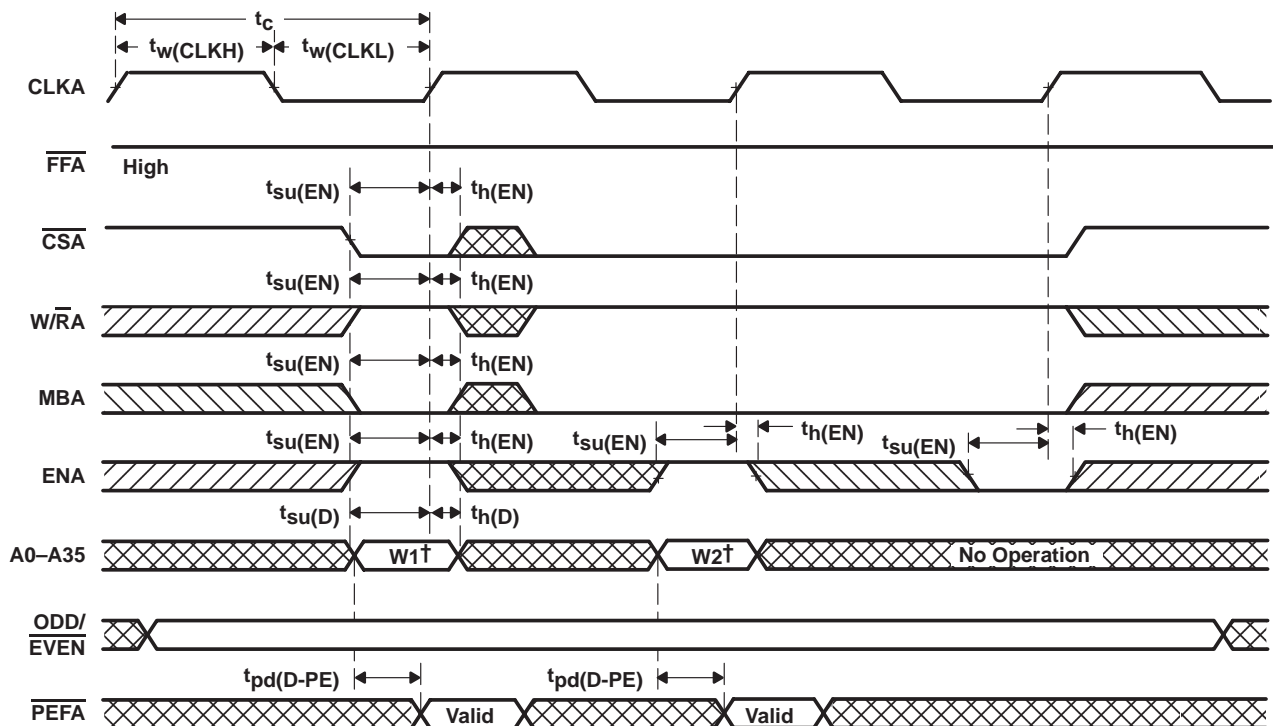

Figure 4. Device Reset Loading the X Register With the Value of Eight



† Written to the FIFO

Figure 5. FIFO Write Cycle



SN74ABT3613
64 × 36 CLOCKED FIRST-IN, FIRST-OUT MEMORY
WITH BUS MATCHING AND BYTE SWAPPING

SCBS128F – JULY 1992 – REVISED APRIL 1998

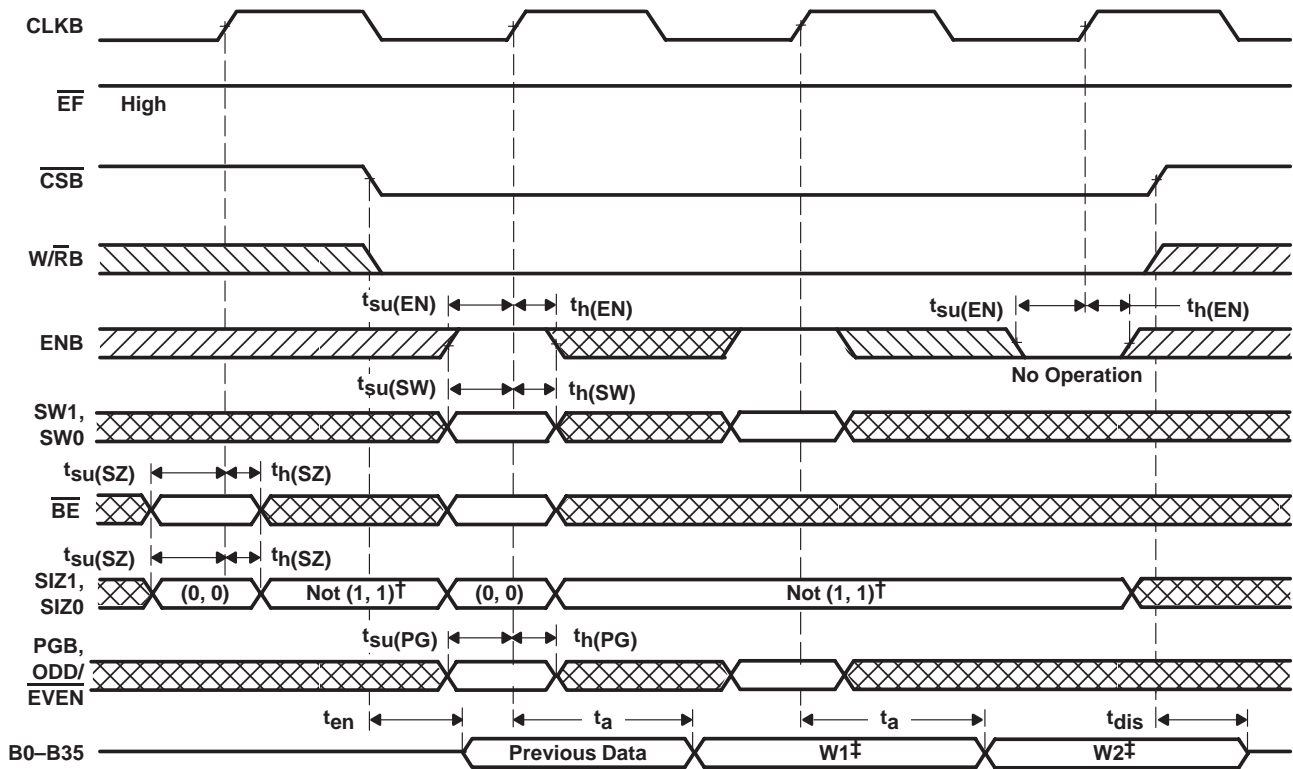

† SIZ0 = H and SIZ1 = H selects the mail1 register for output on B0–B35.

‡ Data read from the FIFO

DATA SWAP FOR FIFO LONG-WORD READS

| FIFO-DATA WRITE | | | | SWAP MODE | | FIFO-DATA READ | | | |
|-----------------|---------|--------|-------|-----------|-----|----------------|---------|--------|-------|
| A35–A27 | A26–A18 | A17–A9 | A8–A0 | SW1 | SW0 | B35–B27 | B26–B18 | B17–B9 | B8–B0 |
| A | B | C | D | L | L | A | B | C | D |
| A | B | C | D | L | H | D | C | B | A |
| A | B | C | D | H | L | C | D | A | B |
| A | B | C | D | H | H | B | A | D | C |

Figure 6. FIFO Long-Word Read Cycle

SN74ABT3613

64 × 36 CLOCKED FIRST-IN, FIRST-OUT MEMORY WITH BUS MATCHING AND BYTE SWAPPING

SCBS128F – JULY 1992 – REVISED APRIL 1998

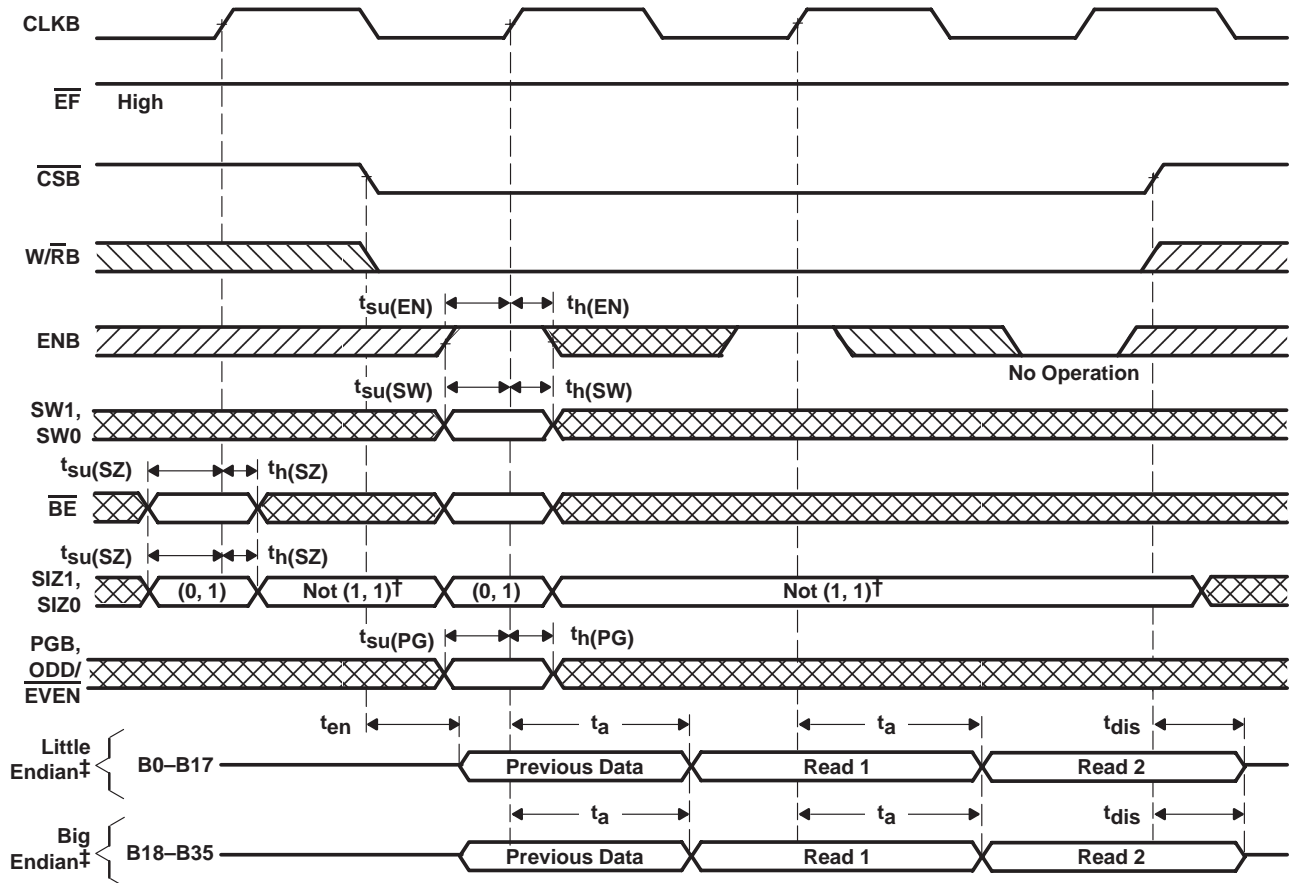

† SIZ0 = H and SIZ1 = H selects the mail1 register for output on B0–B35.

‡ Unused word B0–B17 or B18–B35 holds last FIFO output-register data for word-size reads.

DATA SWAP FOR FIFO-WORD READS

| FIFO-DATA WRITE | | | | SWAP MODE | | READ NO. | FIFO-DATA READ | | | |
|-----------------|---------|--------|-------|-----------|-----|----------|----------------|---------|---------------|-------|
| | | | | | | | BIG ENDIAN | | LITTLE ENDIAN | |
| A35–A27 | A26–A18 | A17–A9 | A8–A0 | SW1 | SW0 | | B35–B27 | B26–B18 | B17–B9 | B8–B0 |
| A | B | C | D | L | L | 1 | A | B | C | D |
| | | | | | | 2 | C | D | A | B |
| A | B | C | D | L | H | 1 | D | C | B | A |
| | | | | | | 2 | B | A | D | C |
| A | B | C | D | H | L | 1 | C | D | A | B |
| | | | | | | 2 | A | B | C | D |
| A | B | C | D | H | H | 1 | B | A | D | C |
| | | | | | | 2 | D | C | B | A |

Figure 7. FIFO-Word Read Cycle

SN74ABT3613
64 × 36 CLOCKED FIRST-IN, FIRST-OUT MEMORY
WITH BUS MATCHING AND BYTE SWAPPING

SCBS128F – JULY 1992 – REVISED APRIL 1998

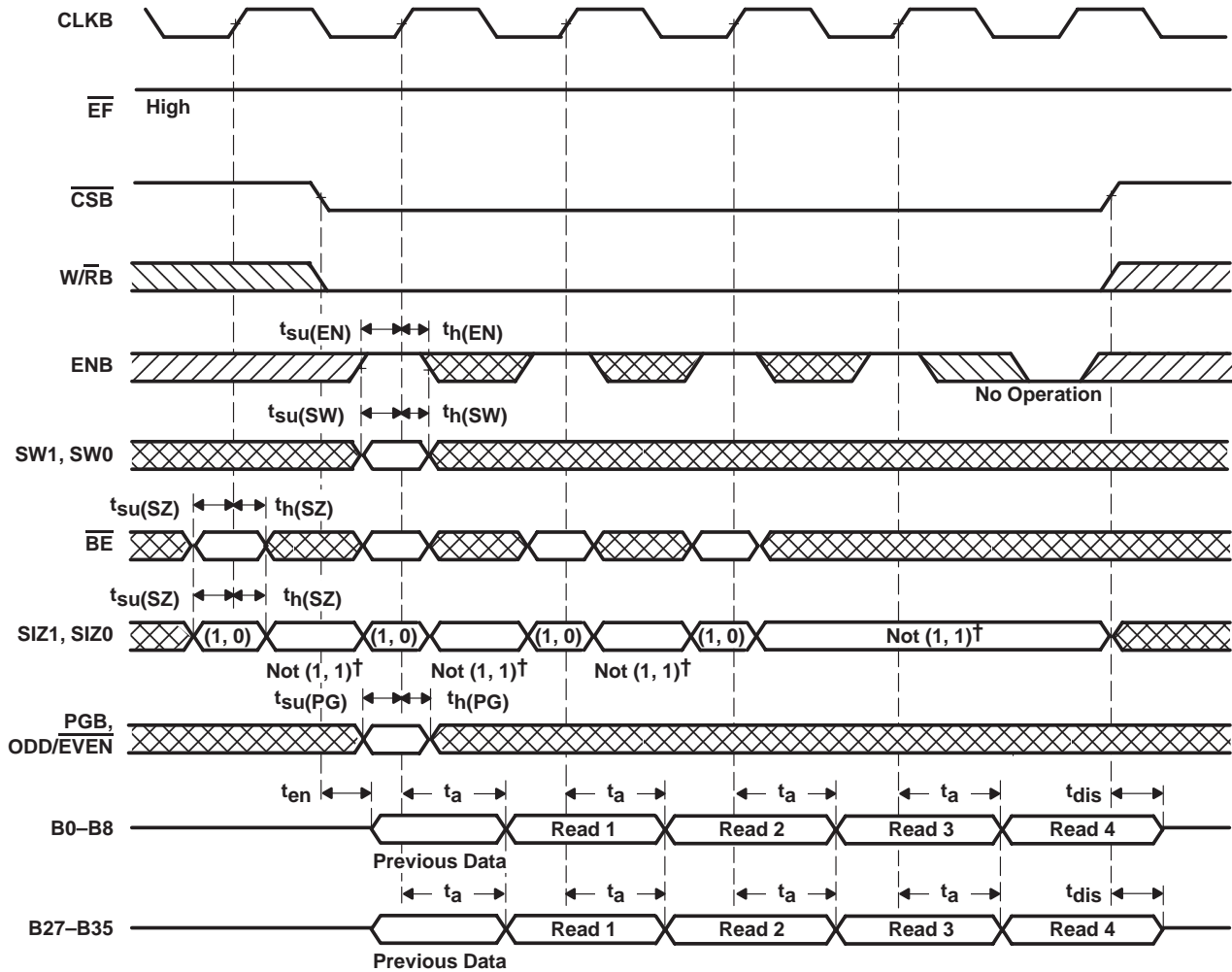

[†] SIZ0 = H and SIZ1 = H selects the mail1 register for output on B0–B35.

NOTE A: Unused bytes hold the last FIFO output-register data for byte-size reads.

Figure 8. FIFO-Byte Read Cycle

SN74ABT3613
**64 × 36 CLOCKED FIRST-IN, FIRST-OUT MEMORY
 WITH BUS MATCHING AND BYTE SWAPPING**
 SCBS128F – JULY 1992 – REVISED APRIL 1998

DATA SWAP FOR FIFO-BYTE READS

| FIFO-DATA WRITE | | | | SWAP MODE | | READ NO. | FIFO-DATA READ | |
|-----------------|---------|--------|-------|-----------|-----|----------|----------------|---------------|
| | | | | | | | BIG ENDIAN | LITTLE ENDIAN |
| A35–A27 | A26–A18 | A17–A9 | A8–A0 | SW1 | SW0 | | B35–B27 | B8–B0 |
| A | B | C | D | L | L | 1 | A | D |
| | | | | | | 2 | B | C |
| | | | | | | 3 | C | B |
| | | | | | | 4 | D | A |
| A | B | C | D | L | h | 1 | D | A |
| | | | | | | 2 | C | B |
| | | | | | | 3 | B | C |
| | | | | | | 4 | A | D |
| A | B | C | D | H | L | 1 | C | B |
| | | | | | | 2 | D | A |
| | | | | | | 3 | A | D |
| | | | | | | 4 | B | C |
| A | B | C | D | H | H | 1 | B | C |
| | | | | | | 2 | A | D |
| | | | | | | 3 | D | A |
| | | | | | | 4 | C | B |

Figure 8. FIFO-Byte Read Cycle (Continued)

SN74ABT3613
64 × 36 CLOCKED FIRST-IN, FIRST-OUT MEMORY
WITH BUS MATCHING AND BYTE SWAPPING

SCBS128F – JULY 1992 – REVISED APRIL 1998

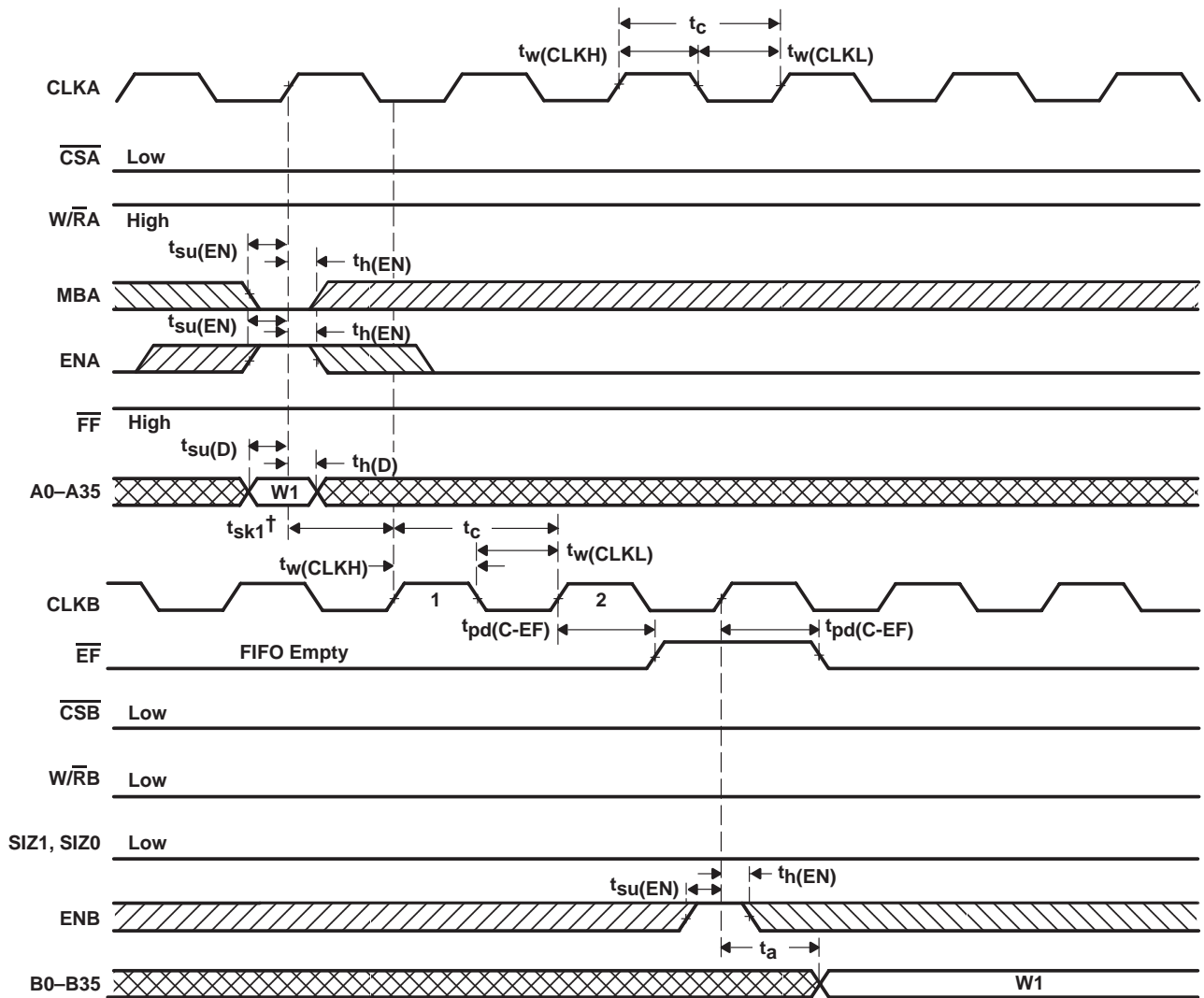

† t_{sk1} is the minimum time between a rising CLKA edge and a rising CLKB edge for \overline{EF} to transition high in the next CLKB cycle. If the time between the rising CLKA edge and rising CLKB edge is less than t_{sk1} , the transition of \overline{EF} high may occur one CLKB cycle later than shown.

NOTE A: Port-B size of long word is selected for the FIFO read by $SIZ1 = L$, $SIZ0 = L$. If port-B size is word or byte, \overline{EF} is set low by the last word or byte read from the FIFO, respectively.

Figure 9. \overline{EF} -Flag Timing and First Data Read When the FIFO Is Empty

SN74ABT3613
**64 × 36 CLOCKED FIRST-IN, FIRST-OUT MEMORY
 WITH BUS MATCHING AND BYTE SWAPPING**

SCBS128F – JULY 1992 – REVISED APRIL 1998

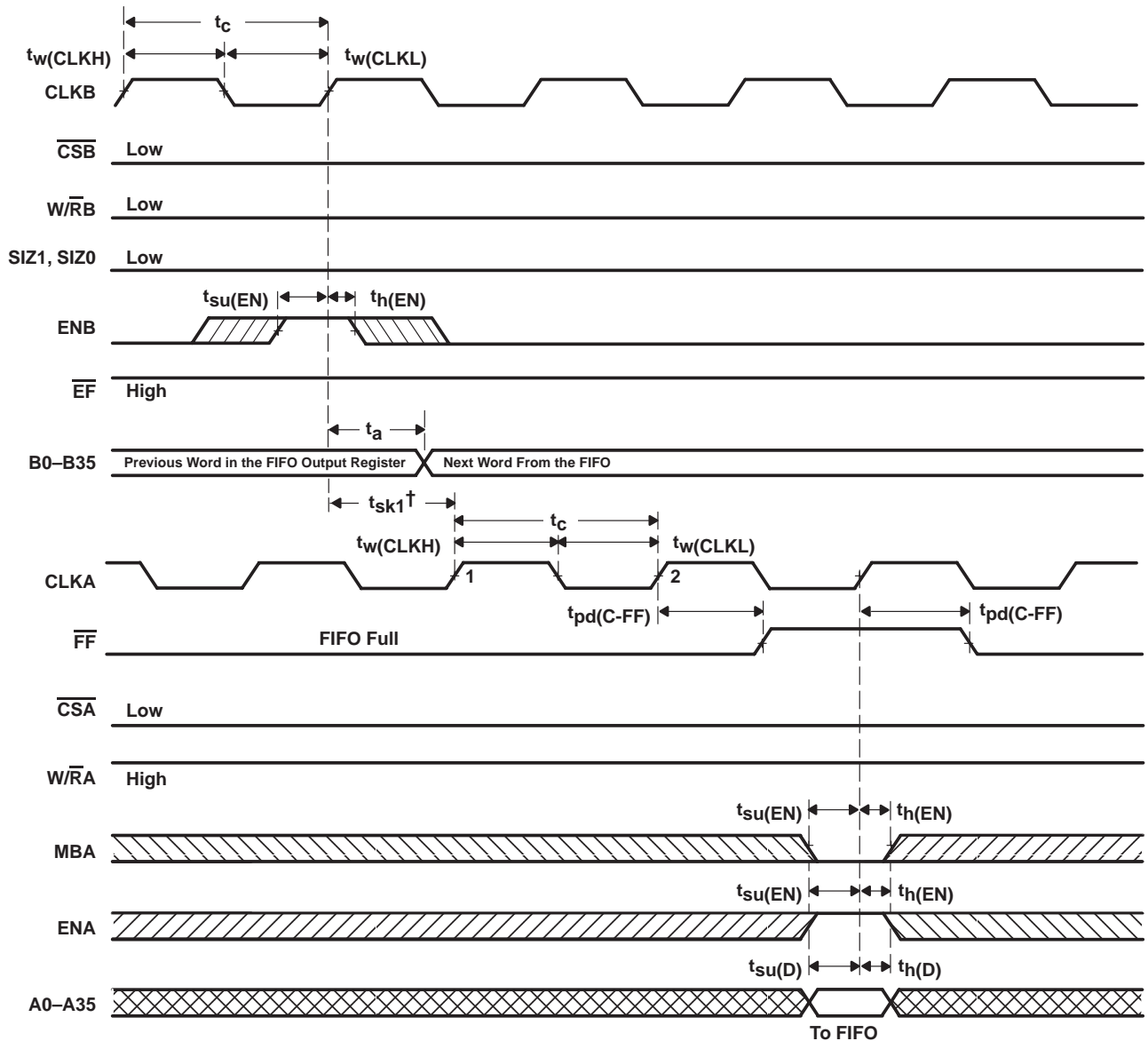

$^\dagger t_{sk1}$ is the minimum time between a rising CLKB edge and a rising CLKA edge for $\overline{\text{FF}}$ to transition high in the next CLKA cycle. If the time between the rising CLKB edge and rising CLKA edge is less than t_{sk1} , $\overline{\text{FF}}$ may transition high one CLKA cycle later than shown.

NOTE A: Port-B size of long word is selected for the FIFO read by $\text{SIZ1} = \text{L}$, $\text{SIZ0} = \text{L}$. If port-B size is word or byte, t_{sk1} is referenced from the rising CLKB edge that reads the first word or byte of the long word, respectively.

Figure 10. $\overline{\text{FF}}$ -Flag Timing and First Available Write When the FIFO Is Full

SN74ABT3613
64 × 36 CLOCKED FIRST-IN, FIRST-OUT MEMORY
WITH BUS MATCHING AND BYTE SWAPPING

SCBS128F – JULY 1992 – REVISED APRIL 1998

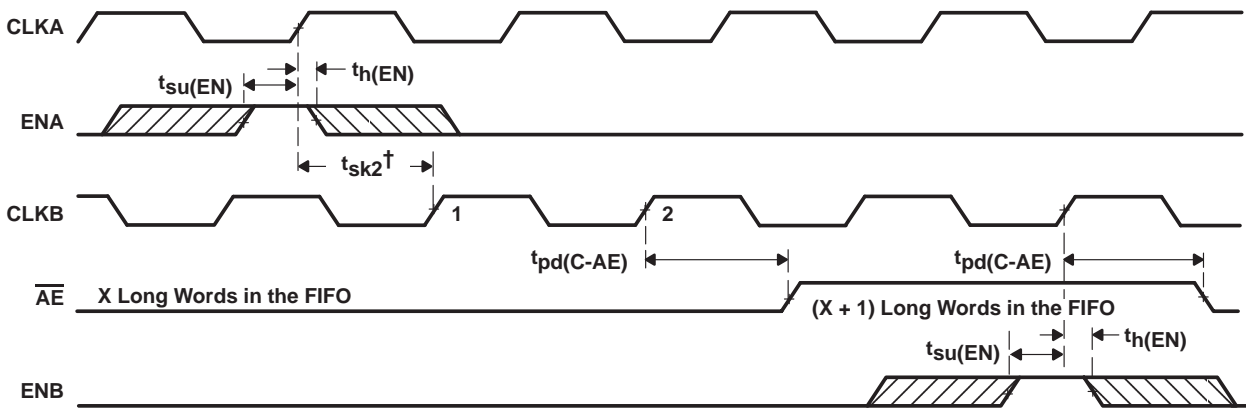

$\dagger t_{sk2}$ is the minimum time between a rising CLKA edge and a rising CLKB edge for \overline{AE} to transition high in the next CLKB cycle. If the time between the rising CLKA edge and rising CLKB edge is less than t_{sk2} , \overline{AE} may transition high one CLKB cycle later than shown.

- NOTES: A. FIFO write ($\overline{CSA} = L$, $W/\overline{RA} = H$, $MBA = L$), FIFO read ($\overline{CSB} = L$, $W/\overline{RB} = L$, $MBB = L$)
 B. Port-B size of long word is selected for FIFO read by $SIZ1 = L$, $SIZ0 = L$. If port-B size is word or byte, t_{sk2} is referenced to the first word or byte read of the long word, respectively.

Figure 11. \overline{AE} When the FIFO Is Almost Empty

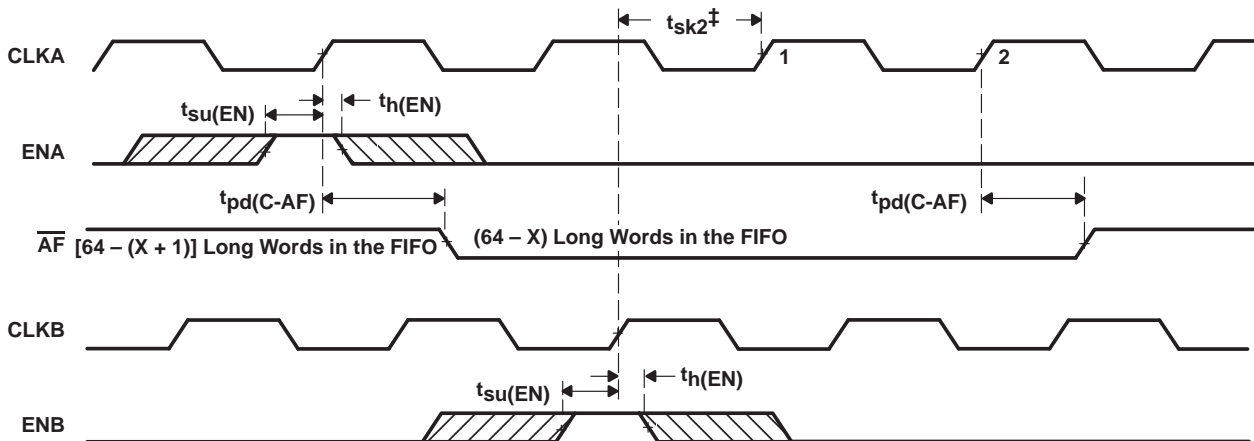

$\dagger t_{sk2}$ is the minimum time between a rising CLKA edge and a rising CLKB edge for \overline{AF} to transition high in the next CLKA cycle. If the time between the rising CLKA edge and rising CLKB edge is less than t_{sk2} , \overline{AF} may transition high one CLKB cycle later than shown.

- NOTES: A. FIFO write ($\overline{CSA} = L$, $W/\overline{RA} = H$, $MBA = L$), FIFO read ($\overline{CSB} = L$, $W/\overline{RB} = L$, $MBB = L$)
 B. Port-B size of long word is selected for FIFO read by $SIZ1 = L$, $SIZ0 = L$. If port-B size is word or byte, t_{sk2} is referenced from the first word or byte read of the long word, respectively.

Figure 12. \overline{AF} When the FIFO Is Almost Full

SN74ABT3613
**64 × 36 CLOCKED FIRST-IN, FIRST-OUT MEMORY
 WITH BUS MATCHING AND BYTE SWAPPING**

SCBS128F – JULY 1992 – REVISED APRIL 1998

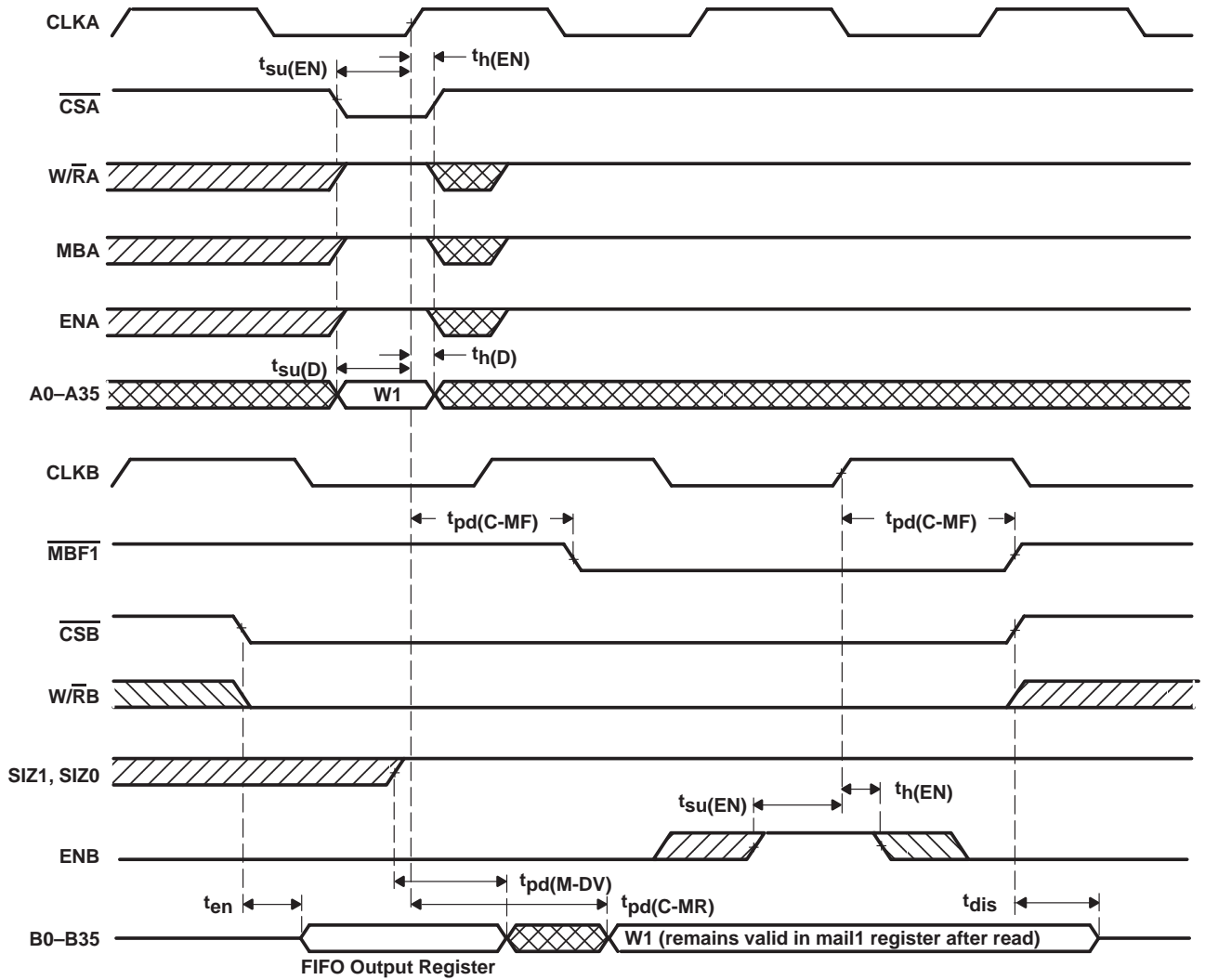

NOTE A: Port-B parity generation off (PGB = L)

Figure 13. Mail1 Register and $\overline{MBF1}$ Flag

SN74ABT3613
64 × 36 CLOCKED FIRST-IN, FIRST-OUT MEMORY
WITH BUS MATCHING AND BYTE SWAPPING

SCBS128F – JULY 1992 – REVISED APRIL 1998

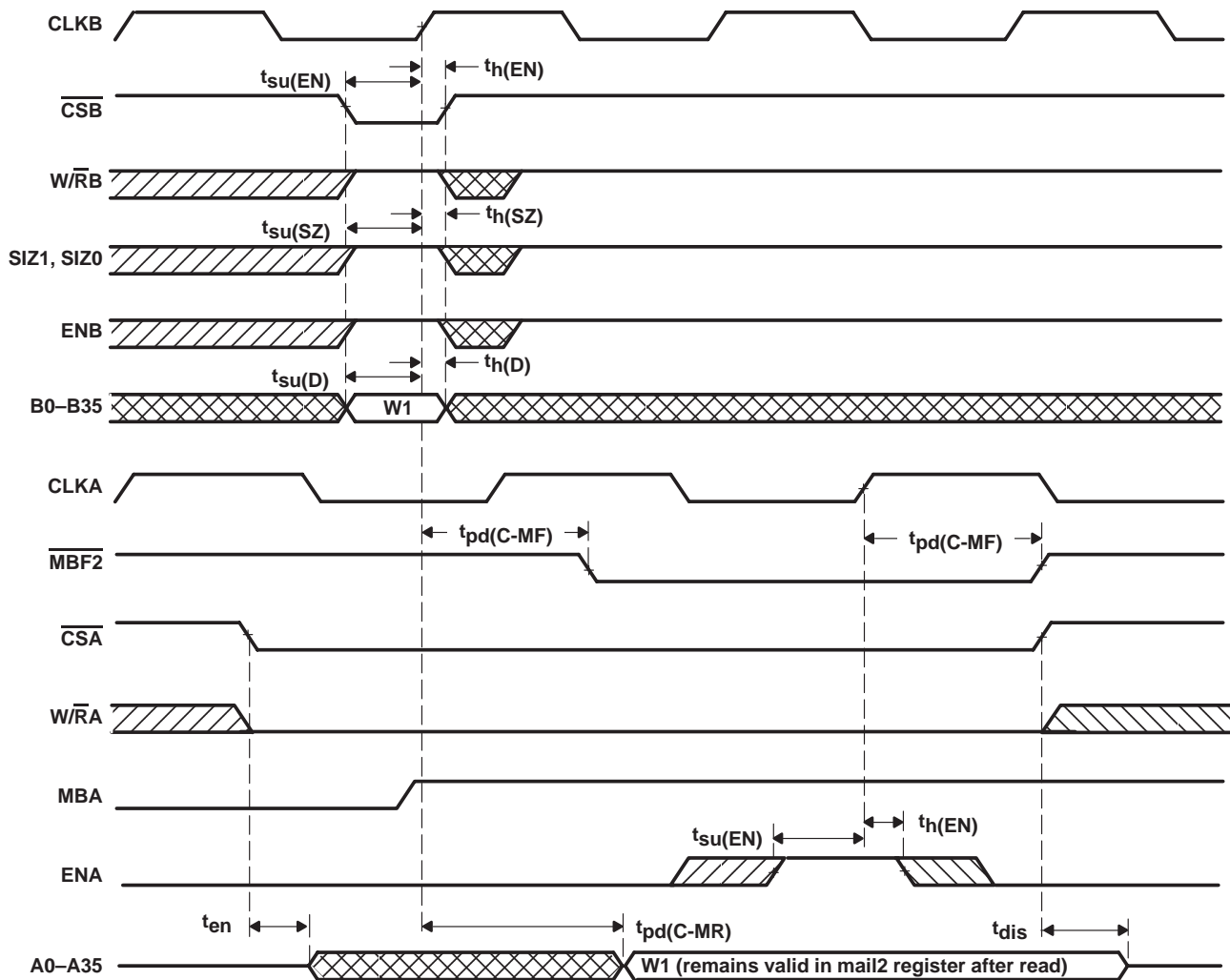

NOTE A: Port-A parity generation off (PGA = L)

Figure 14. Mail2 Register and $\overline{MBF2}$ Flag

SN74ABT3613
**64 × 36 CLOCKED FIRST-IN, FIRST-OUT MEMORY
 WITH BUS MATCHING AND BYTE SWAPPING**

SCBS128F – JULY 1992 – REVISED APRIL 1998

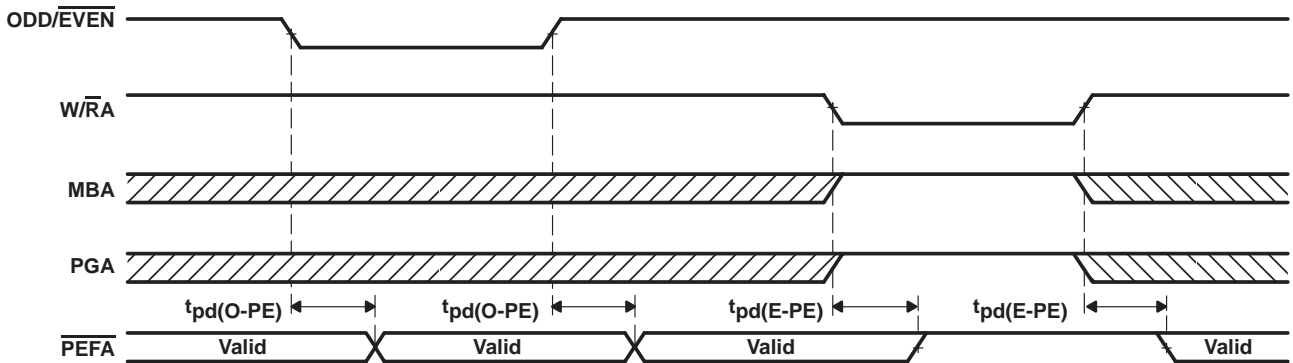

NOTE A: $\overline{\text{CSA}} = \text{L}$ and $\text{ENA} = \text{H}$

Figure 15. $\overline{\text{ODD/EVEN}}$, $\overline{\text{W/RA}}$, $\overline{\text{MBA}}$, and $\overline{\text{PGA}}$ to $\overline{\text{PEFA}}$

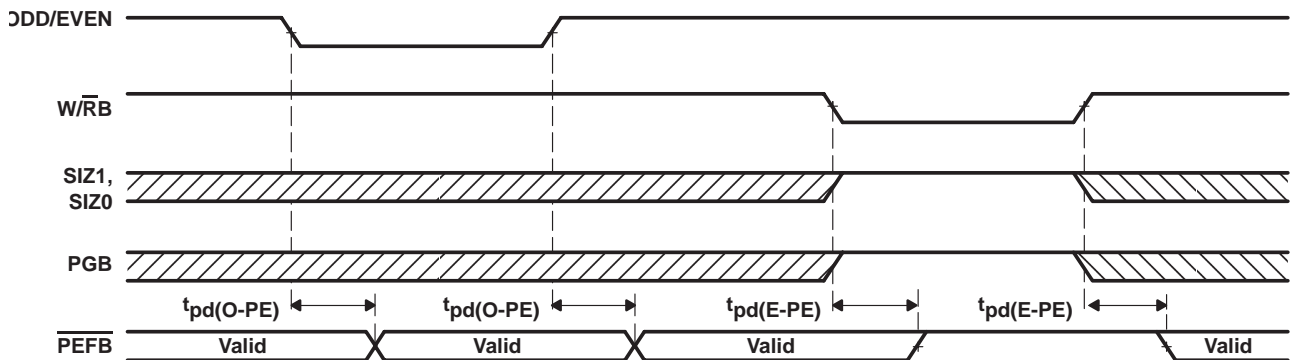

NOTE A: $\overline{\text{CSB}} = \text{L}$ and $\text{ENB} = \text{H}$

Figure 16. $\overline{\text{ODD/EVEN}}$, $\overline{\text{W/RB}}$, $\overline{\text{SIZ1}}$, $\overline{\text{SIZ0}}$, and $\overline{\text{PGB}}$ to $\overline{\text{PEFB}}$

SN74ABT3613
64 × 36 CLOCKED FIRST-IN, FIRST-OUT MEMORY
WITH BUS MATCHING AND BYTE SWAPPING

SCBS128F – JULY 1992 – REVISED APRIL 1998

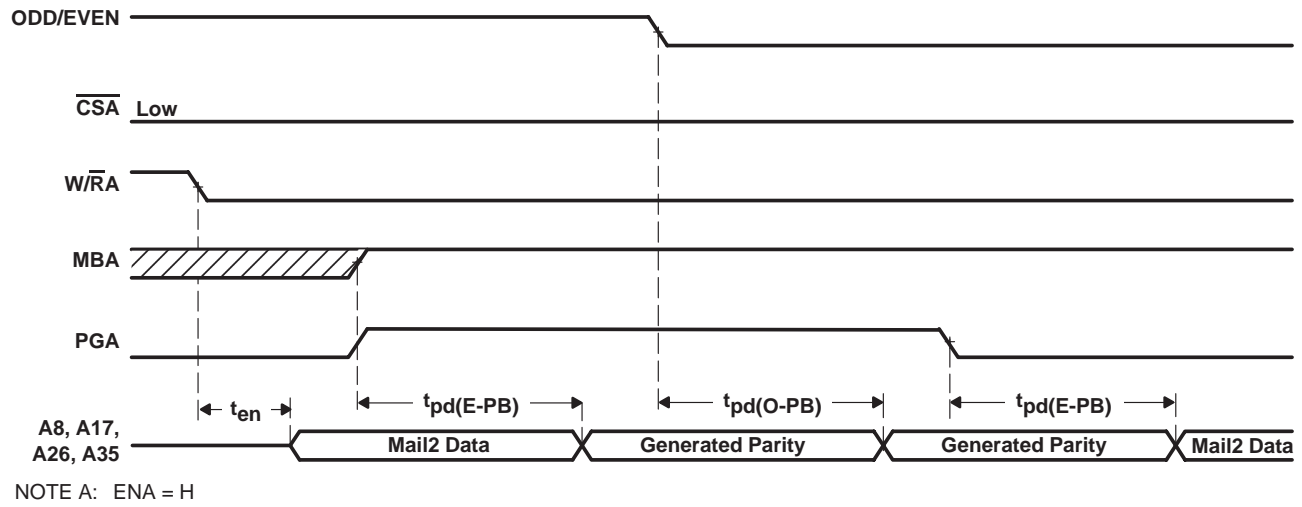

Figure 17. Parity Generation When Reading From the Mail2 Register

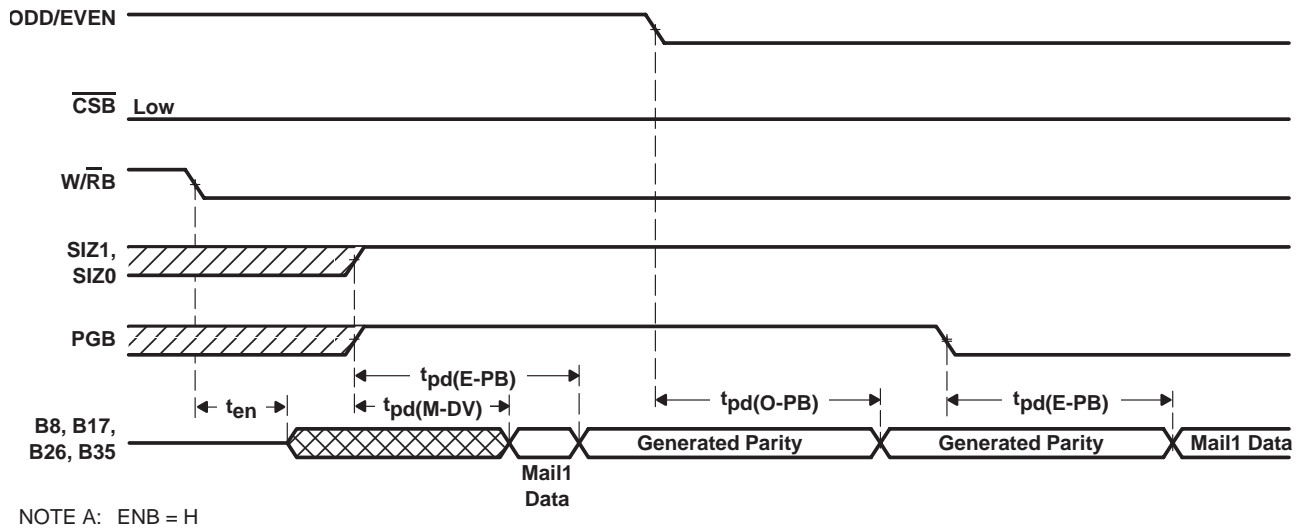

Figure 18. Parity Generation When Reading From the Mail1 Register

SN74ABT3613
64 × 36 CLOCKED FIRST-IN, FIRST-OUT MEMORY
WITH BUS MATCHING AND BYTE SWAPPING

SCBS128F – JULY 1992 – REVISED APRIL 1998

absolute maximum ratings over operating free-air temperature range (unless otherwise noted)†

| | |
|--|----------------------------|
| Supply voltage range, V_{CC} | -0.5 V to 7 V |
| Input voltage range, V_I (see Note 1) | -0.5 V to $V_{CC} + 0.5$ V |
| Output voltage range, V_O (see Note 1) | -0.5 V to $V_{CC} + 0.5$ V |
| Input clamp current, I_{IK} ($V_I < 0$ or $V_I > V_{CC}$) | ±20 mA |
| Output clamp current, I_{OK} ($V_O < 0$ or $V_O > V_{CC}$) | ±50 mA |
| Continuous output current, I_O ($V_O = 0$ to V_{CC}) | ±50 mA |
| Continuous current through V_{CC} or GND | ±500 mA |
| Package thermal impedance, θ_{JA} (see Note 2): PCB package | 28°C/W |
| PQ package | 46°C/W |
| Storage temperature range, T_{stg} | -65°C to 150°C |

† Stresses beyond those listed under “absolute maximum ratings” may cause permanent damage to the device. These are stress ratings only, and functional operation of the device at these or any other conditions beyond those indicated under “recommended operating conditions” is not implied. Exposure to absolute-maximum-rated conditions for extended periods may affect device reliability.

- NOTES: 1. The input and output voltage ratings may be exceeded provided the input and output current ratings are observed.
2. The package thermal impedance is calculated in accordance with JESD 51.

recommended operating conditions

| | MIN | MAX | UNIT |
|--------------------------------------|-----|-----|------|
| V_{CC} Supply voltage | 4.5 | 5.5 | V |
| V_{IH} High-level input voltage | 2 | | V |
| V_{IL} Low-level input voltage | | 0.8 | V |
| I_{OH} High-level output current | | -4 | mA |
| I_{OL} Low-level output current | | 8 | mA |
| T_A Operating free-air temperature | 0 | 70 | °C |

electrical characteristics over recommended operating free-air temperature range (unless otherwise noted)

| PARAMETER | TEST CONDITIONS | MIN | TYP‡ | MAX | UNIT |
|-----------|---|------------------|------|-----|------|
| V_{OH} | $V_{CC} = 4.5$ V, $I_{OH} = -4$ mA | 2.4 | | | V |
| V_{OL} | $V_{CC} = 4.5$ V, $I_{OL} = 8$ mA | | | 0.5 | V |
| I_I | $V_{CC} = 5.5$ V, $V_I = V_{CC}$ or 0 | | | ±50 | µA |
| I_{OZ} | $V_{CC} = 5.5$ V, $V_O = V_{CC}$ or 0 | | | ±50 | µA |
| I_{CC} | $V_{CC} = 5.5$ V, $I_O = 0$ mA, $V_I = V_{CC}$ or GND | Outputs high | | 60 | mA |
| | | Outputs low | | 130 | |
| | | Outputs disabled | | 60 | |
| C_i | $V_I = 0$, $f = 1$ MHz | | 4 | | pF |
| C_o | $V_O = 0$, $f = 1$ MHz | | 8 | | pF |

‡ All typical values are at $V_{CC} = 5$ V, $T_A = 25^\circ\text{C}$.



SN74ABT3613
64 × 36 CLOCKED FIRST-IN, FIRST-OUT MEMORY
WITH BUS MATCHING AND BYTE SWAPPING

SCBS128F – JULY 1992 – REVISED APRIL 1998

timing requirements over recommended ranges of supply voltage and operating free-air temperature (see Figures 4 through 19)

| | | 'ABT3613-15 | | 'ABT3613-20 | | 'ABT3613-30 | | UNIT |
|-----------------------------|---|-------------|-----|-------------|-----|-------------|-----|------|
| | | MIN | MAX | MIN | MAX | MIN | MAX | |
| f_{clock} | Clock frequency, CLKA or CLKB | 66.7 | | 50 | | 33.4 | | MHz |
| t_{C} | Clock cycle time, CLKA or CLKB | 15 | | 20 | | 30 | | ns |
| $t_{\text{w}}(\text{CLKH})$ | Pulse duration, CLKA and CLKB high | 6 | | 8 | | 12 | | ns |
| $t_{\text{w}}(\text{CLKL})$ | Pulse duration, CLKA and CLKB low | 6 | | 8 | | 12 | | ns |
| $t_{\text{su}}(\text{D})$ | Setup time, A0–A35 before CLKA↑ and B0–B35 before CLKB↑ | 4 | | 5 | | 6 | | ns |
| $t_{\text{su}}(\text{EN})$ | Setup time, $\overline{\text{CSA}}$, W/ $\overline{\text{RA}}$, ENA, and MBA before CLKA↑; $\overline{\text{CSB}}$, W/ $\overline{\text{RB}}$, and ENB before CLKB↑ | 5 | | 5 | | 6 | | ns |
| $t_{\text{su}}(\text{SZ})$ | Setup time, SIZ0, SIZ1, and $\overline{\text{BE}}$ before CLKB↑ | 4 | | 5 | | 6 | | ns |
| $t_{\text{su}}(\text{SW})$ | Setup time, SW0 and SW1 before CLKB↑ | 5 | | 7 | | 8 | | ns |
| $t_{\text{su}}(\text{PG})$ | Setup time, $\overline{\text{ODD/EVEN}}$ and PGB before CLKB↑† | 4 | | 5 | | 6 | | ns |
| $t_{\text{su}}(\text{RS})$ | Setup time, $\overline{\text{RST}}$ low before CLKA↑ or CLKB↑‡ | 5 | | 6 | | 7 | | ns |
| $t_{\text{su}}(\text{FS})$ | Setup time, FS0 and FS1 before $\overline{\text{RST}}$ high | 5 | | 6 | | 7 | | ns |
| $t_{\text{h}}(\text{D})$ | Hold time, A0–A35 after CLKA↑ and B0–B35 after CLKB↑ | 1 | | 1 | | 1 | | ns |
| $t_{\text{h}}(\text{EN})$ | Hold time, $\overline{\text{CSA}}$, W/ $\overline{\text{RA}}$, ENA, and MBA after CLKA↑; $\overline{\text{CSB}}$, W/ $\overline{\text{RB}}$, and ENB after CLKB↑ | 1 | | 1 | | 1 | | ns |
| $t_{\text{h}}(\text{SZ})$ | Hold time, SIZ0, SIZ1, and $\overline{\text{BE}}$ after CLKB↑ | 2 | | 2 | | 2 | | ns |
| $t_{\text{h}}(\text{SW})$ | Hold time, SW0 and SW1 after CLKB↑ | 0 | | 0 | | 0 | | ns |
| $t_{\text{h}}(\text{PG})$ | Hold time, $\overline{\text{ODD/EVEN}}$ and PGB after CLKB↑† | 0 | | 0 | | 0 | | ns |
| $t_{\text{h}}(\text{RS})$ | Hold time, $\overline{\text{RST}}$ low after CLKA↑ or CLKB↑‡ | 5 | | 6 | | 7 | | ns |
| $t_{\text{h}}(\text{FS})$ | Hold time, FS0 and FS1 after $\overline{\text{RST}}$ high | 4 | | 4 | | 4 | | ns |
| $t_{\text{sk}1}^{\S}$ | Skew time between CLKA↑ and CLKB↑ for $\overline{\text{EF}}$ and $\overline{\text{FF}}$ | 8 | | 8 | | 10 | | ns |
| $t_{\text{sk}2}^{\S}$ | Skew time between CLKA↑ and CLKB↑ for $\overline{\text{AE}}$ and $\overline{\text{AF}}$ | 9 | | 16 | | 20 | | ns |

† Applies only for a clock edge that does a FIFO read

‡ Requirement to count the clock edge as one of at least four needed to reset a FIFO

§ Skew time is not a timing constraint for proper device operation and is included only to illustrate the timing relationship between CLKA cycle and CLKB cycle.



SN74ABT3613
64 × 36 CLOCKED FIRST-IN, FIRST-OUT MEMORY
WITH BUS MATCHING AND BYTE SWAPPING

SCBS128F – JULY 1992 – REVISED APRIL 1998

switching characteristics over recommended ranges of supply voltage and operating free-air temperature, $C_L = 30$ pF (see Figures 4 through 19)

| PARAMETER | 'ABT3613-15 | | 'ABT3613-20 | | 'ABT3613-30 | | UNIT |
|-----------------------------|---|-----|-------------|-----|-------------|-----|------|
| | MIN | MAX | MIN | MAX | MIN | MAX | |
| f_{max} | 66.7 | | 50 | | 33.4 | | MHz |
| t_a | Access time, $CLKA \uparrow$ to A0–A35 and $CLKB \uparrow$ to B0–B35 | | | | | | |
| $t_{pd}(C-FF)$ | Propagation delay time, $CLKA \uparrow$ to \overline{FF} | | | | | | |
| $t_{pd}(C-EF)$ | Propagation delay time, $CLKB \uparrow$ to \overline{EF} | | | | | | |
| $t_{pd}(C-AE)$ | Propagation delay time, $CLKB \uparrow$ to \overline{AE} | | | | | | |
| $t_{pd}(C-AF)$ | Propagation delay time, $CLKA \uparrow$ to \overline{AF} | | | | | | |
| $t_{pd}(C-MF)$ | Propagation delay time, $CLKA \uparrow$ to $\overline{MBF1}$ low or $\overline{MBF2}$ high and $CLKB \uparrow$ to $\overline{MBF2}$ low or $\overline{MBF1}$ high | | | | | | |
| $t_{pd}(C-MR)$ | Propagation delay time, $CLKA \uparrow$ to B0–B35 [†] and $CLKB \uparrow$ to A0–A35 [‡] | | | | | | |
| $t_{pd}(C-PE)$ [§] | Propagation delay time, $CLKB \uparrow$ to \overline{PEFB} | | | | | | |
| $t_{pd}(M-DV)$ | Propagation delay time, SIZ1, SIZ0 to B0–B35 valid | | | | | | |
| $t_{pd}(D-PE)$ | Propagation delay time, A0–A35 valid to \overline{PEFA} valid; B0–B35 valid to \overline{PEFB} valid | | | | | | |
| $t_{pd}(O-PE)$ | Propagation delay time, ODD/\overline{EVEN} to \overline{PEFA} and \overline{PEFB} | | | | | | |
| $t_{pd}(O-PB)$ [¶] | Propagation delay time, ODD/\overline{EVEN} to parity bits (A8, A17, A26, A35) and (B8, B17, B26, B35) | | | | | | |
| $t_{pd}(E-PE)$ | Propagation delay time, \overline{CSA} , \overline{ENA} , $\overline{W/RA}$, \overline{MBA} , or \overline{PGA} to \overline{PEFA} ; \overline{CSB} , \overline{ENB} , $\overline{W/RB}$, SIZ1, SIZ0, or \overline{PGB} to \overline{PEFB} | | | | | | |
| $t_{pd}(E-PB)$ [¶] | Propagation delay time, \overline{CSA} , \overline{ENA} , $\overline{W/RA}$, \overline{MBA} , or \overline{PGA} to parity bits (A8, A17, A26, A35); \overline{CSB} , \overline{ENB} , $\overline{W/RB}$, SIZ1, SIZ0, or \overline{PGB} to parity bits (B8, B17, B26, B35) | | | | | | |
| $t_{pd}(R-F)$ | Propagation delay time, \overline{RST} to \overline{AE} , \overline{EF} low and \overline{AF} , $\overline{MBF1}$, $\overline{MBF2}$ high | | | | | | |
| t_{en} | Enable time, \overline{CSA} and $\overline{W/RA}$ low to A0–A35 active and \overline{CSB} low and $\overline{W/RB}$ high to B0–B35 active | | | | | | |
| t_{dis} | Disable time, \overline{CSA} or $\overline{W/RA}$ high to A0–A35 at high impedance and \overline{CSB} high or $\overline{W/RB}$ low to B0–B35 at high impedance | | | | | | |

[†] Writing data to the mail1 register when the B0–B35 outputs are active and SIZ1 and SIZ0 are high

[‡] Writing data to the mail2 register when the A0–A35 outputs are active and \overline{MBA} is high

[§] Applies only when a new port-B bus size is implemented by the rising $CLKB$ edge

[¶] Applies only when reading data from a mail register



SN74ABT3613
64 × 36 CLOCKED FIRST-IN, FIRST-OUT MEMORY
WITH BUS MATCHING AND BYTE SWAPPING

SCBS128F – JULY 1992 – REVISED APRIL 1998

PARAMETER MEASUREMENT INFORMATION

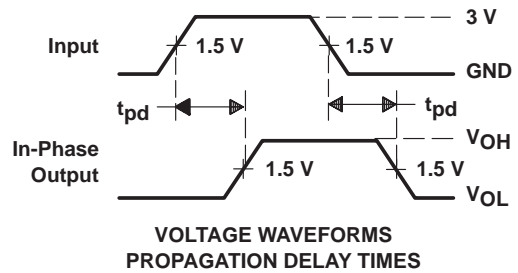
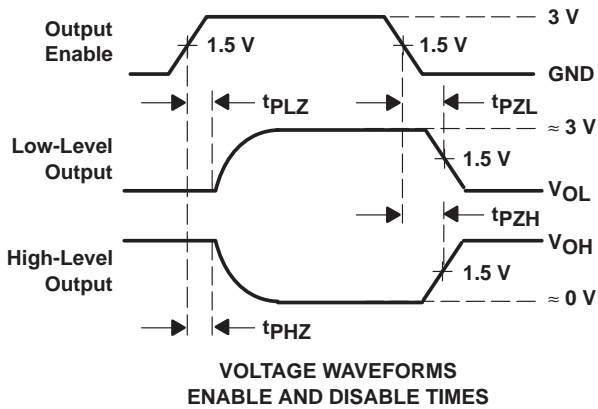
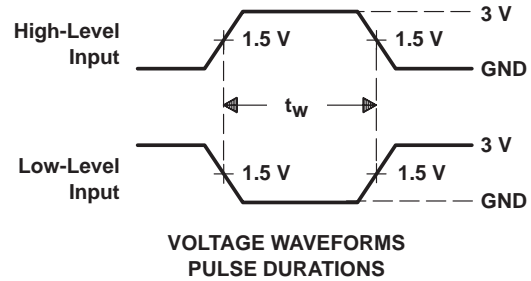
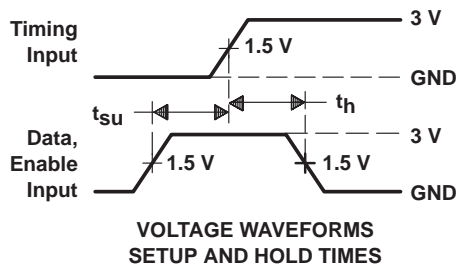
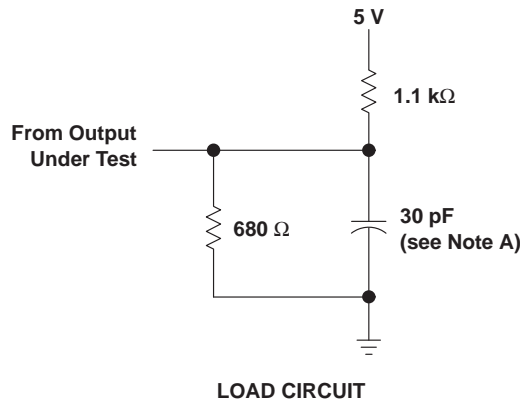

- NOTES: A. Includes probe and jig capacitance
 B. t_{pZL} and t_{pZH} are the same as t_{en}
 C. t_{pLZ} and t_{pHZ} are the same as t_{dis}

Figure 19. Load Circuit and Voltage Waveforms

TYPICAL CHARACTERISTICS

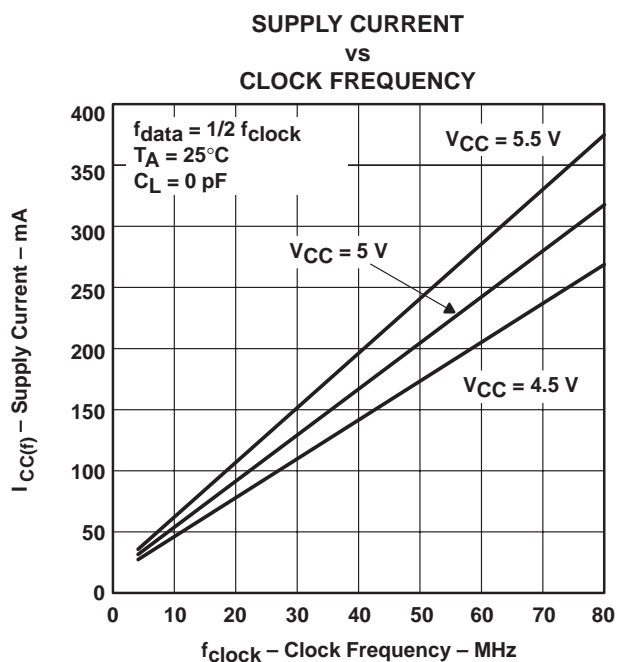

Figure 20

IMPORTANT NOTICE

Texas Instruments and its subsidiaries (TI) reserve the right to make changes to their products or to discontinue any product or service without notice, and advise customers to obtain the latest version of relevant information to verify, before placing orders, that information being relied on is current and complete. All products are sold subject to the terms and conditions of sale supplied at the time of order acknowledgement, including those pertaining to warranty, patent infringement, and limitation of liability.

TI warrants performance of its semiconductor products to the specifications applicable at the time of sale in accordance with TI's standard warranty. Testing and other quality control techniques are utilized to the extent TI deems necessary to support this warranty. Specific testing of all parameters of each device is not necessarily performed, except those mandated by government requirements.

CERTAIN APPLICATIONS USING SEMICONDUCTOR PRODUCTS MAY INVOLVE POTENTIAL RISKS OF DEATH, PERSONAL INJURY, OR SEVERE PROPERTY OR ENVIRONMENTAL DAMAGE ("CRITICAL APPLICATIONS"). TI SEMICONDUCTOR PRODUCTS ARE NOT DESIGNED, AUTHORIZED, OR WARRANTED TO BE SUITABLE FOR USE IN LIFE-SUPPORT DEVICES OR SYSTEMS OR OTHER CRITICAL APPLICATIONS. INCLUSION OF TI PRODUCTS IN SUCH APPLICATIONS IS UNDERSTOOD TO BE FULLY AT THE CUSTOMER'S RISK.

In order to minimize risks associated with the customer's applications, adequate design and operating safeguards must be provided by the customer to minimize inherent or procedural hazards.

TI assumes no liability for applications assistance or customer product design. TI does not warrant or represent that any license, either express or implied, is granted under any patent right, copyright, mask work right, or other intellectual property right of TI covering or relating to any combination, machine, or process in which such semiconductor products or services might be or are used. TI's publication of information regarding any third party's products or services does not constitute TI's approval, warranty or endorsement thereof.