

- Free-Running CLKA and CLKB Can Be Asynchronous or Coincident
- Clocked FIFO Buffering Data From Port A to Port B
- Synchronous Read-Retransmit Capability
- Mailbox Register in Each Direction
- Programmable Almost-Full and Almost-Empty Flags
- Microprocessor Interface Control Logic
- Input-Ready and  $\overline{AF}$  Flags Synchronized by CLKA
- Output-Ready and  $\overline{AE}$  Flags Synchronized by CLKB
- Low-Power 0.8- $\mu$ m Advanced CMOS Technology
- Supports Clock Frequencies up to 67 MHz
- Fast Access Times of 11 ns
- Pin-to-Pin Compatible With SN74ACT3631 and SN74ACT3641
- Package Options Include 120-Pin Thin Quad Flat (PCB) and 132-Pin Plastic Quad Flat (PQ) Packages

## description

The SN74ACT3651 is a high-speed, low-power, CMOS clocked FIFO memory that supports clock frequencies up to 67 MHz and has read access times as fast as 11 ns. The 2048 × 36 dual-port SRAM FIFO buffers data from port A to port B. The FIFO memory has retransmit capability, which allows previously read data to be accessed again. The FIFO has flags to indicate empty and full conditions and two programmable flags (almost full and almost empty) to indicate when a selected number of words is stored in memory. Communication between each port takes place with two 36-bit mailbox registers. Each mailbox register has a flag that signals when new mail has been stored. Two or more devices are used in parallel to create wider data paths. Expansion is also possible in word depth.

The SN74ACT3651 is a clocked FIFO, which means each port employs a synchronous interface. All data transfers through a port are gated to the low-to-high transition of a continuous (free-running) port clock by enable signals. The continuous clocks for each port are independent of one another and can be asynchronous or coincident. The enables for each port are arranged to provide a simple interface between microprocessors and/or buses with synchronous control.

The input-ready (IR) flag and almost-full ( $\overline{AF}$ ) flag of the FIFO are two-stage synchronized to CLKA. The output-ready (OR) flag and almost-empty ( $\overline{AE}$ ) flag of the FIFO are two-stage synchronized to CLKB. Offset values for  $\overline{AF}$  and  $\overline{AE}$  are programmed from port A or through a serial input.

The SN74ACT3651 is characterized for operation from 0°C to 70°C.

For more information on this device family, see the following application reports:

- *FIFO Patented Synchronous Retransmit: Programmable DSP-Interface Application for FIR Filtering* (literature number SCAA009)
- *FIFO Mailbox-Bypass Registers: Using Bypass Registers to Initialize DMA Control* (literature number SCAA007)
- *Metastability Performance of Clocked FIFOs* (literature number SCZA004)



Please be aware that an important notice concerning availability, standard warranty, and use in critical applications of Texas Instruments semiconductor products and disclaimers thereto appears at the end of this data sheet.

PRODUCTION DATA information is current as of publication date. Products conform to specifications per the terms of Texas Instruments standard warranty. Production processing does not necessarily include testing of all parameters.

 **TEXAS  
INSTRUMENTS**

POST OFFICE BOX 655303 • DALLAS, TEXAS 75265

Copyright © 1999, Texas Instruments Incorporated

**SN74ACT3651**  
**2048 × 36**  
**CLOCKED FIRST-IN, FIRST-OUT MEMORY**

SCAS439D – JUNE 1994 – REVISED FEBRUARY 1999

**PCB PACKAGE**  
**(TOP VIEW)**

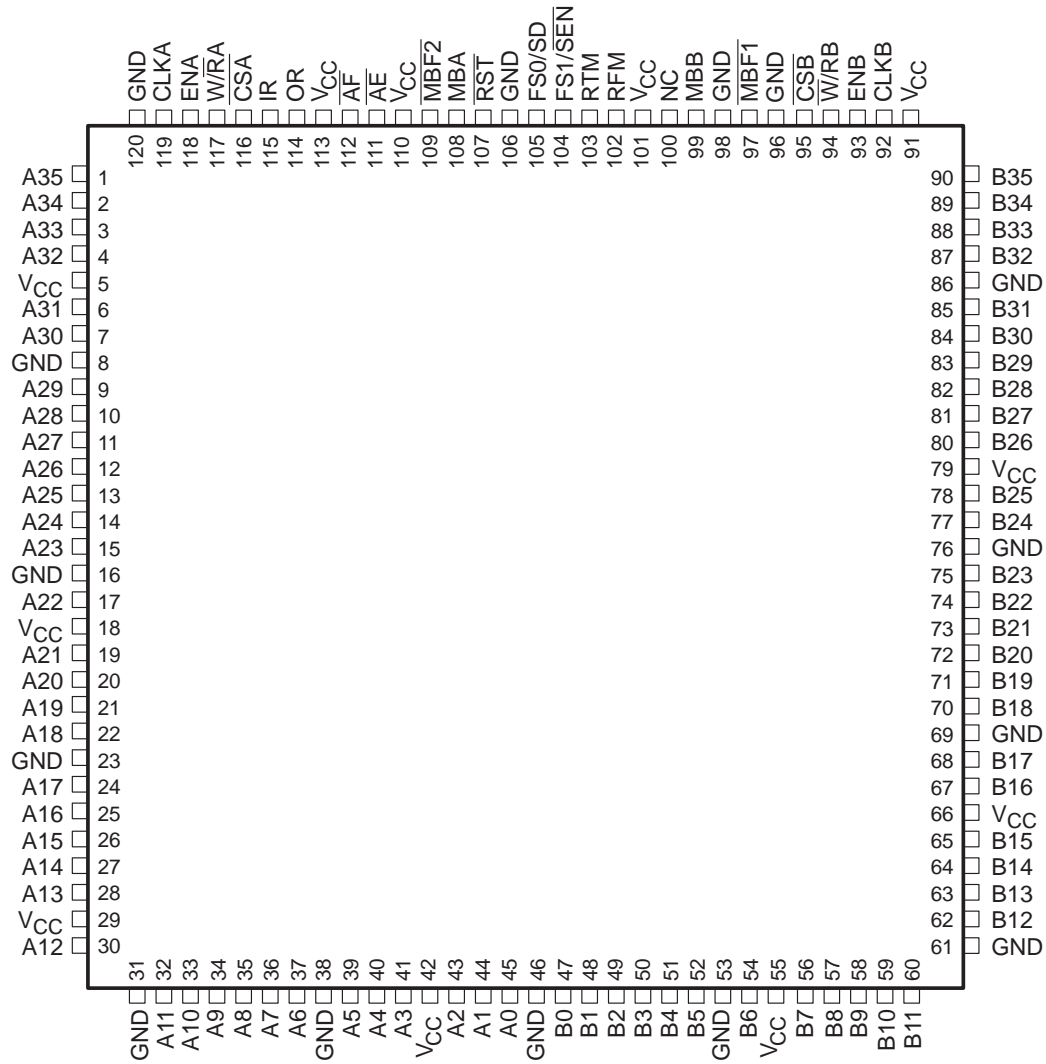

NC – No internal connection



POST OFFICE BOX 655303 • DALLAS, TEXAS 75265

SN74ACT3651  
2048 × 36  
**CLOCKED FIRST-IN, FIRST-OUT MEMORY**  
SCAS439D – JUNE 1994 – REVISED FEBRUARY 1999

**PQ PACKAGE†  
(TOP VIEW)**

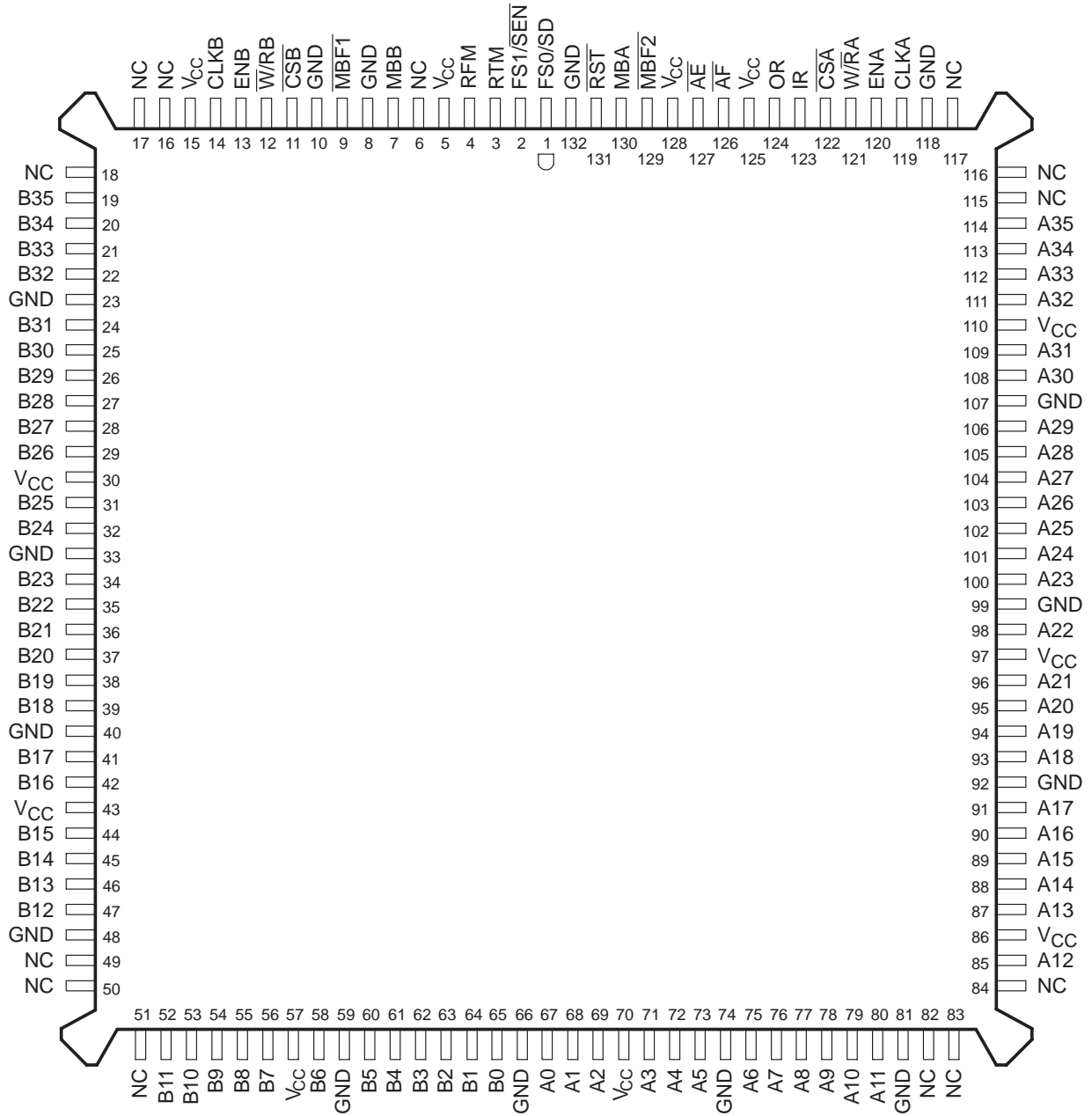

NC – No internal connection  
† Uses Yamaichi socket IC51-1324-828



SN74ACT3651  
 2048 × 36  
 CLOCKED FIRST-IN, FIRST-OUT MEMORY  
 SCAS439D – JUNE 1994 – REVISED FEBRUARY 1999

functional block diagram

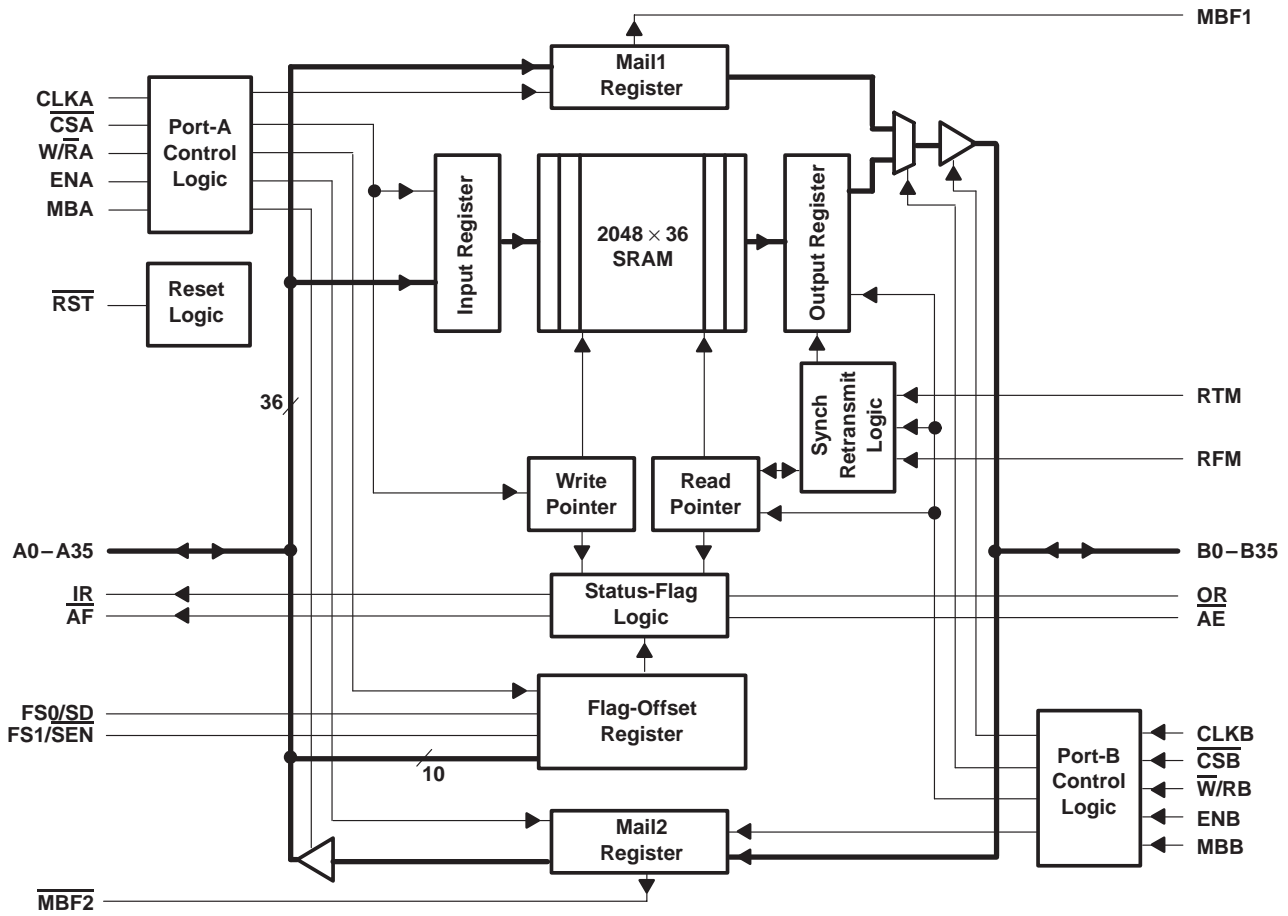

## Terminal Functions

TERMINAL NAME	I/O	DESCRIPTION
A0–A35	I/O	Port-A data. The 36-bit bidirectional data port for side A.
$\overline{AE}$	O	Almost-empty flag. Programmable flag synchronized to CLKB. $\overline{AE}$ is low when the number of words in the FIFO is less than or equal to the value in the almost-empty offset register (X).
$\overline{AF}$	O	Almost-full flag. Programmable flag synchronized to CLKA. $\overline{AF}$ is low when the number of empty locations in the FIFO is less than or equal to the value in the almost-full offset register (Y).
B0–B35	I/O	Port-B data. The 36-bit bidirectional data port for side B.
CLKA	I	Port-A clock. CLKA is a continuous clock that synchronizes all data transfers through port A and can be asynchronous or coincident to CLKB. IR and $\overline{AF}$ are synchronous to the low-to-high transition of CLKA.
CLKB	I	Port-B clock. CLKB is a continuous clock that synchronizes all data transfers through port B and can be asynchronous or coincident to CLKA. OR and $\overline{AE}$ are synchronous to the low-to-high transition of CLKB.
$\overline{CSA}$	I	Port-A chip select. $\overline{CSA}$ must be low to enable a low-to-high transition of CLKA to read or write data on port A. The A0–A35 outputs are in the high-impedance state when $\overline{CSA}$ is high.
$\overline{CSB}$	I	Port-B chip select. $\overline{CSB}$ must be low to enable a low-to-high transition of CLKB to read or write data on port B. The B0–B35 outputs are in the high-impedance state when $\overline{CSB}$ is high.
ENA	I	Port-A master enable. ENA must be high to enable a low-to-high transition of CLKA to read or write data on port A.
ENB	I	Port-B master enable. ENB must be high to enable a low-to-high transition of CLKB to read or write data on port B.
FS1/ $\overline{SEN}$ , FS0/SD	I	Flag-offset select 1/serial enable, flag-offset select 0/serial data. FS1/ $\overline{SEN}$ and FS0/SD are dual-purpose inputs used for flag-offset-register programming. During a device reset, FS1/ $\overline{SEN}$ and FS0/SD select the flag-offset programming method. Three offset-register programming methods are available: automatically load one of two preset values, parallel load from port A, and serial load.  When serial load is selected for flag-offset-register programming, FS1/ $\overline{SEN}$ is used as an enable synchronous to the low-to-high transition of CLKA. When FS1/ $\overline{SEN}$ is low, a rising edge on CLKA loads the bit present on FS0/SD into the X- and Y-offset registers. The number of bit writes required to program the offset registers is 22. The first bit write stores the Y-register MSB and the last bit write stores the X-register LSB.
IR	O	Input-ready flag. IR is synchronized to the low-to-high transition of CLKA. When IR is low, the FIFO is full and writes to its array are disabled. When the FIFO is in retransmit mode, IR indicates when the memory has been filled to the point of the retransmit data and prevents further writes. IR is set low during reset and is set high after reset.
MBA	I	Port-A mailbox select. A high level on MBA chooses a mailbox register for a port-A read or write operation.
MBB	I	Port-B mailbox select. A high level on MBB chooses a mailbox register for a port-B read or write operation. When the B0–B35 outputs are active, a high level on MBB selects data from the mail1 register for output and a low level selects FIFO data for output.
$\overline{MBF1}$	O	Mail1 register flag. $\overline{MBF1}$ is set low by the low-to-high transition of CLKA that writes data to the mail1 register. $\overline{MBF1}$ is set high by a low-to-high transition of CLKB when a port-B read is selected and MBB is high. $\overline{MBF1}$ is set high by a reset.
$\overline{MBF2}$	O	Mail2 register flag. $\overline{MBF2}$ is set low by the low-to-high transition of CLKB that writes data to the mail2 register. $\overline{MBF2}$ is set high by a low-to-high transition of CLKA when a port-A read is selected and MBA is high. $\overline{MBF2}$ is set high by a reset.
OR	O	Output-ready flag. OR is synchronized to the low-to-high transition of CLKB. When OR is low, the FIFO is empty and reads are disabled. Ready data is present in the output register of the FIFO when OR is high. OR is forced low during the reset and goes high on the third low-to-high transition of CLKB after a word is loaded to empty memory.
RFM	I	Read from mark. When the FIFO is in retransmit mode, a high on RFM enables a low-to-high transition of CLKB to reset the read pointer to the beginning retransmit location and output the first selected retransmit data.
$\overline{RST}$	I	Reset. To reset the device, four low-to-high transitions of CLKA and four low-to-high transitions of CLKB must occur while $\overline{RST}$ is low. The low-to-high transition of $\overline{RST}$ latches the status of FS0 and FS1 for $\overline{AF}$ and $\overline{AE}$ offset selection.
RTM	I	Retransmit mode. When RTM is high and valid data is present in the FIFO output register (OR is high), a low-to-high transition of CLKB selects the data for the beginning of a retransmit and puts the FIFO in retransmit mode. The selected word remains the initial retransmit point until a low-to-high transition of CLKB occurs while RTM is low, taking the FIFO out of retransmit mode.

**SN74ACT3651**  
**2048 × 36**  
**CLOCKED FIRST-IN, FIRST-OUT MEMORY**  
 SCAS439D – JUNE 1994 – REVISED FEBRUARY 1999

**Terminal Functions (Continued)**

TERMINAL NAME	I/O	DESCRIPTION
$\overline{W}/\overline{RA}$	I	Port-A write/read select. A high on $\overline{W}/\overline{RA}$ selects a write operation and a low selects a read operation on port A for a low-to-high transition of CLK <sub>A</sub> . The A0–A35 outputs are in the high-impedance state when $\overline{W}/\overline{RA}$ is high.
$\overline{W}/\overline{RB}$	I	Port-B write/read select. A low on $\overline{W}/\overline{RB}$ selects a write operation and a high selects a read operation on port B for a low-to-high transition of CLK <sub>B</sub> . The B0–B35 outputs are in the high-impedance state when $\overline{W}/\overline{RB}$ is low.

**detailed description**

**reset**

The SN74ACT3651 is reset by taking the reset ( $\overline{RST}$ ) input low for at least four port-A clock (CLK<sub>A</sub>) and four port-B clock (CLK<sub>B</sub>) low-to-high transitions. The reset input can switch asynchronously to the clocks. A reset initializes the memory-read and-write pointers and forces the IR flag low, the OR flag high, the AE flag low, and the AF flag high. Resetting the device also forces the mailbox flags ( $\overline{MBF1}$ ,  $\overline{MBF2}$ ) high. After a FIFO is reset, IR is set high after at least two clock cycles to begin normal operation. A FIFO must be reset after power up before data is written to its memory.

**almost-empty flag and almost-full flag offset programming**

Two registers in the SN74ACT3651 are used to hold the offset values for the  $\overline{AE}$  and  $\overline{AF}$  flags. The  $\overline{AE}$  flag offset register is labeled X, and the  $\overline{AF}$  flag offset register is labeled Y. The offset registers can be loaded with a value in three ways: one of two preset values is loaded into the offset registers, parallel load from port A, or serial load. The offset-register-programming mode is chosen by the flag select (FS1, FS0) inputs during a low-to-high transition on  $\overline{RST}$  (see Table 1).

**Table 1. Flag Programming**

FS1	FS0	RST	X AND Y REGISTERST
H	H	↑	Serial load
H	L	↑	64
L	H	↑	8
L	L	↑	Parallel load from port A

† X register holds the offset for  $\overline{AE}$ ; Y register holds the offset for  $\overline{AF}$ .

**preset values**

If a preset value of 8 or 64 is chosen by FS1 and FS0 at the time of an  $\overline{RST}$  low-to-high transition according to Table 1, the preset value is automatically loaded into the X and Y registers. No other device initialization is necessary to begin normal operation, and the IR flag is set high after two low-to-high transitions on CLK<sub>A</sub>.

**parallel load from port A**

To program the X and Y registers from port A, the device is reset with FS0 and FS1 low during the low-to-high transition of  $\overline{RST}$ . After this reset is complete, the IR flag is set high after two low-to-high transitions on CLK<sub>A</sub>. The first two writes to the FIFO do not store data in its memory but load the offset registers in the order Y, X. Each offset register of the SN74ACT3651 uses port-A inputs (A10–A0). The highest number input is used as the most-significant bit of the binary number in each case. Each register value can be programmed from 1 to 2044. After both offset registers are programmed from port A, subsequent FIFO writes store data in the SRAM.



**serial load**

To program the X and Y registers serially, the device is reset with FS0/SD and FS1/ $\overline{\text{SEN}}$  high during the low-to-high transition of  $\overline{\text{RST}}$ . After this reset is complete, the X and Y register values are loaded bitwise through FS0/SD on each low-to-high transition of CLKA that FS1/ $\overline{\text{SEN}}$  is low. Twenty-two bit writes are needed to complete the programming. The first bit write stores the most-significant bit of the Y register and the last bit write stores the least-significant bit of the X register. Each register value can be programmed from 1 to 2044.

When the option is chosen to program the offset registers serially, the IR flag remains low until all register bits are written. The IR flag is set high by the low-to-high transition of CLKA after the last bit is loaded, to allow normal FIFO operation.

**FIFO write/read operation**

The state of the port-A data (A0–A35) outputs is controlled by the port-A chip select ( $\overline{\text{CSA}}$ ) and the port-A write/read select ( $\overline{\text{W/RA}}$ ). The A0–A35 outputs are in the high-impedance state when either  $\overline{\text{CSA}}$  or  $\overline{\text{W/RA}}$  is high. The A0–A35 outputs are active when both  $\overline{\text{CSA}}$  and  $\overline{\text{W/RA}}$  are low.

Data is loaded into the FIFO from the A0–A35 inputs on a low-to-high transition of CLKA when  $\overline{\text{CSA}}$  and the port-A mailbox select (MBA) are low,  $\overline{\text{W/RA}}$ , the port-A enable (ENA), and the IR flag are high (see Table 2). Writes to the FIFO are independent of any concurrent FIFO reads.

**Table 2. Port-A Enable Function Table**

CSA	$\overline{\text{W/RA}}$	ENA	MBA	CLKA	A0–A35 OUTPUTS	PORT FUNCTION
H	X	X	X	X	In high-impedance state	None
L	H	L	X	X	In high-impedance state	None
L	H	H	L	↑	In high-impedance state	FIFO write
L	H	H	H	↑	In high-impedance state	Mail1 write
L	L	L	L	X	Active, mail2 register	None
L	L	H	L	↑	Active, mail2 register	None
L	L	L	H	X	Active, mail2 register	None
L	L	H	H	↑	Active, mail2 register	Mail2 read (set $\overline{\text{MBF2}}$ high)

The port-B control signals are identical to those of port A, with the exception that the port-B write/read select ( $\overline{\text{W/RB}}$ ) is the inverse of the  $\overline{\text{W/RA}}$ . The state of the port-B data (B0–B35) outputs is controlled by the port-B chip select ( $\overline{\text{CSB}}$ ) and  $\overline{\text{W/RB}}$ . The B0–B35 outputs are in the high-impedance state when either  $\overline{\text{CSB}}$  is high or  $\overline{\text{W/RB}}$  is low. The B0–B35 outputs are active when  $\overline{\text{CSB}}$  is low and  $\overline{\text{W/RB}}$  is high.

Data is read from the FIFO to its output register on a low-to-high transition of CLKB when  $\overline{\text{CSB}}$  and MBB are low,  $\overline{\text{W/RB}}$ , ENB, and the OR flag are high (see Table 3). Reads from the FIFO are independent of any concurrent FIFO writes.

Table 3. Port-B Enable Function Table

CSB	$\overline{W/RB}$	ENB	MBB	CLKB	B0–B35 OUTPUTS	PORT FUNCTION
H	X	X	X	X	In high-impedance state	None
L	L	L	X	X	In high-impedance state	None
L	L	H	L	↑	In high-impedance state	None
L	L	H	H	↑	In high-impedance state	Mail2 write
L	H	L	L	X	Active, FIFO output register	None
L	H	H	L	↑	Active, FIFO output register	FIFO read
L	H	L	H	X	Active, mail1 register	None
L	H	H	H	↑	Active, mail1 register	Mail1 read (set $\overline{MBF1}$ high)

The setup- and hold-time constraints to the port clocks for the port-chip selects and write/read selects are only for enabling write and read operations and are not related to high-impedance control of the data outputs. If a port enable is low during a clock cycle, the port-chip select and write/read select can change states during the setup- and hold-time window of the cycle.

When OR is low, the next data word is sent to the FIFO output register automatically by the CLKB low-to-high transition that sets OR high. When OR is high, an available data word is clocked to the FIFO output register only when a FIFO read is selected by  $\overline{CSB}$ ,  $\overline{W/RB}$ , ENB, and MBB.

**synchronized FIFO flags**

Each FIFO flag is synchronized to its port clock through at least two flip-flop stages. This is done to improve the flag's reliability by reducing the probability of metastable events on their outputs when CLKA and CLKB operate asynchronously with one another. OR and  $\overline{AE}$  are synchronized to CLKB. IR and  $\overline{AF}$  are synchronized to CLKA. Table 4 shows the relationship of each flag to the number of words stored in memory.

Table 4. FIFO Flag Operation

NUMBER OF WORDS IN FIFO†‡	SYNCHRONIZED TO CLKB		SYNCHRONIZED TO CLKA	
	OR	AE	AF	IR
0	L	L	H	H
1 to X	H	L	H	H
(X + 1) to [2048 – (Y + 1)]	H	H	H	H
(2048 – Y) to 2047	H	H	L	H
2048	H	H	L	L

† X is the almost-empty offset for  $\overline{AE}$ . Y is the almost-full offset for  $\overline{AF}$ .

‡ When a word is present in the FIFO output register, its previous memory location is free.



### **output-ready flag**

The OR flag of a FIFO is synchronized to CLKB. When OR is high, new data is present in the FIFO output register. When OR is low, the previous data word is present in the FIFO output register and attempted FIFO reads are ignored.

A FIFO read pointer is incremented each time a new word is clocked to its output register. When a word is written to a FIFO, it can be shifted to the FIFO output register in a minimum of three cycles of CLKB; therefore, an OR flag is low if a word in memory is the next data to be sent to the FIFO output register and three CLKB cycles have not elapsed since the word was written. The output-ready flag of the FIFO remains low until the third low-to-high transition of CLKB occurs, simultaneously forcing the OR flag high and shifting the word to the FIFO output register.

A low-to-high transition on CLKB begins the first synchronization cycle of a write if the clock transition occurs at time  $t_{sk(1)}$ , or greater, after the write. Otherwise, the subsequent CLKB cycle can be the first synchronization cycle (see Figure 6).

### **input-ready flag**

The IR flag of a FIFO is synchronized to the CLKA. When the IR flag is high, a memory location is free in the SRAM to write new data. No memory locations are free when the IR flag is low and attempted writes to the FIFO are ignored.

Each time a word is written to a FIFO, its write pointer is incremented. When a word is read from a FIFO, its previous memory location can be written in a minimum of three cycles of CLKA; therefore, an IR flag is low if less than two cycles of CLKA have elapsed since the next memory write location has been read. The second low-to-high transition on CLKA after the read sets the IR flag high, and data can be written in the following cycle.

A low-to-high transition on CLKA begins the first synchronization cycle of a read if the clock transition occurs at time  $t_{sk(1)}$ , or greater, after the read. Otherwise, the subsequent CLKA cycle can be the first synchronization cycle (see Figure 7).

### **almost-empty flag**

The  $\overline{AE}$  flag of a FIFO is synchronized to CLKB. The almost-empty state is defined by the contents of register X. This register is loaded with a preset value during a FIFO reset, programmed from port A, or programmed serially (see *almost-empty flag and almost-full flag offset programming*). The  $\overline{AE}$  flag is low when the FIFO contains X or fewer words and is high when the FIFO contains (X + 1) or more words. A data word present in the FIFO output register has been read from memory.

Two low-to-high transitions of CLKB are required after a FIFO write for the  $\overline{AE}$  flag to reflect the new level of fill; therefore, the  $\overline{AE}$  flag of a FIFO containing (X + 1) or more words remains low if two cycles of CLKB have not elapsed since the write that filled the memory to the (X + 1) level. An  $\overline{AE}$  flag is set high by the second low-to-high transition of CLKB after the FIFO write that fills memory to the (X + 1) level. A low-to-high transition of CLKB begins the first synchronization cycle if it occurs at time  $t_{sk(2)}$ , or greater, after the write that fills the FIFO to (X + 1) words. Otherwise, the subsequent CLKB cycle can be the first synchronization cycle (see Figure 8).

**SN74ACT3651**  
**2048 × 36**  
**CLOCKED FIRST-IN, FIRST-OUT MEMORY**  
SCAS439D – JUNE 1994 – REVISED FEBRUARY 1999

---

**almost-full flag**

The AF flag of a FIFO is synchronized to the port clock that writes data to its array (CLKA). The almost-full state is defined by the contents of register Y. This register is loaded with a preset value during a FIFO reset, programmed from port A, or programmed serially (see *almost-empty flag and almost-full flag offset programming*). The AF flag is low when the number of words in the FIFO is greater than or equal to  $2048 - Y$ . The AF flag is high when the number of words in the FIFO is less than or equal to  $[2048 - (Y + 1)]$ . A data word present in the FIFO output register has been read from memory.

Two low-to-high transitions of CLKA are required after a FIFO read for its AF flag to reflect the new level of fill. Therefore, the AF flag of a FIFO containing  $[2048 - (Y + 1)]$  or less words remains low if two cycles of CLKA have not elapsed since the read that reduced the number of words in memory to  $[2048 - (Y + 1)]$ . An AF flag is set high by the second low-to-high transition of CLKA after the FIFO read that reduces the number of words in memory to  $[2048 - (Y + 1)]$ . A low-to-high transition of CLKA begins the first synchronization cycle if it occurs at time  $t_{sk(2)}$ , or greater, after the read that reduces the number of words in memory to  $[2048 - (Y + 1)]$ . Otherwise, the subsequent CLKA cycle can be the first synchronization cycle (see Figure 9).

**synchronous retransmit**

The synchronous-retransmit feature of the SN74ACT3651 allows FIFO data to be read repeatedly starting at a user-selected position. The FIFO is first put into retransmit mode (RTM) to select a beginning word and prevent ongoing FIFO write operations from destroying retransmit data. Data vectors with a minimum length of three words can retransmit repeatedly, starting at the selected word. The FIFO can be taken out of RTM at any time without affecting normal device operation.

The FIFO is put in retransmit mode by a low-to-high transition on CLKB when the RTM input is high and OR is high. This rising CLKB edge marks the data present in the FIFO output register as the first retransmit data. The FIFO goes out of retransmit mode when RTM goes low (see Figure 10).

When two or more reads have been done past the initial retransmit word, a retransmit is initiated by a low-to-high transition on CLKB when the read-from-mark (RFM) input is high. This rising CLKB edge shifts the first retransmit word to the FIFO output register and subsequent reads can begin immediately. Retransmit loops can be done endlessly while the FIFO is in RTM. RFM must be low during the CLKB rising edge that takes the FIFO out of retransmit mode.

When the FIFO is put into RTM, it operates with two read pointers. The current read pointer operates normally, incrementing each time a new word is shifted to the FIFO output register and used by the OR and  $\overline{AE}$  flags. The shadow read pointer stores the SRAM location at the time the device is put into RTM and does not change until the device is taken out of RTM. The shadow read pointer is used by the IR and  $\overline{AF}$  flags. Data writes can proceed while the FIFO is in RTM, but  $\overline{AF}$  is set low by the write that stores  $(2048 - Y)$  words after the first retransmit word. The IR flag is set low by the 2048th write after the first retransmit word.

When the FIFO is in RTM and RFM is high, a rising CLKB edge loads the current read pointer with the shadow read-pointer value and the OR flag reflects the new level of fill immediately. If the retransmit changes the FIFO status out of the almost-empty range, up to two CLKB rising edges after the retransmit cycle are needed to switch  $\overline{AE}$  high (see Figure 11). The rising CLKB edge that takes the FIFO out of retransmit mode shifts the read pointer used by the IR and  $\overline{AF}$  flags from the shadow to the current read pointer. If the change of read pointer used by IR and  $\overline{AF}$  should cause one or both flags to transition high, at least two CLKA synchronizing cycles are needed before the flags reflect the change. A rising CLKA edge after the FIFO is taken out of retransmit mode is the first synchronizing cycle of IR if it occurs at time  $t_{sk(1)}$ , or greater, after the rising CLKB edge (see Figure 12). A rising CLKA edge after the FIFO is taken out of RTM is the first synchronizing cycle of  $\overline{AF}$  if it occurs at time  $t_{sk(2)}$ , or greater, after the rising CLKB edge (see Figure 14).

**mailbox registers**

Two 36-bit bypass registers pass command and control information between port A and port B. The mailbox-select (MBA, MBB) inputs choose between a mail register and a FIFO for a port data-transfer operation. A low-to-high transition on CLKA writes A0–A35 data to the mail1 register when a port-A write is selected by  $\overline{CSA}$ ,  $\overline{W/RA}$ , and ENA with MBA high. A low-to-high transition on CLKB writes B0–B35 data to the mail2 register when a port-B write is selected by  $\overline{CSB}$ ,  $\overline{W/RB}$ , and ENB with MBB high. Writing data to a mail register sets its corresponding flag (MBF1 or MBF2) low. Attempted writes to a mail register are ignored while its mail flag is low.

When the port-B data (B0–B35) outputs are active, the data on the bus comes from the FIFO output register when the MBB input is low and from the mail1 register when MBB is high. Mail2 data is always present on the port-A data (A0–A35) outputs when they are active. The mail1 register flag ( $\overline{MBF1}$ ) is set high by a low-to-high transition on CLKB when a port-B read is selected by  $\overline{CSB}$ ,  $\overline{W/RB}$ , and ENB with MBB high. The mail2 register flag ( $\overline{MBF2}$ ) is set high by a low-to-high transition on CLKA when a port-A read is selected by  $\overline{CSA}$ ,  $\overline{W/RA}$ , and ENA with MBA high. The data in a mail register remains intact after it is read and changes only when new data is written to the register.

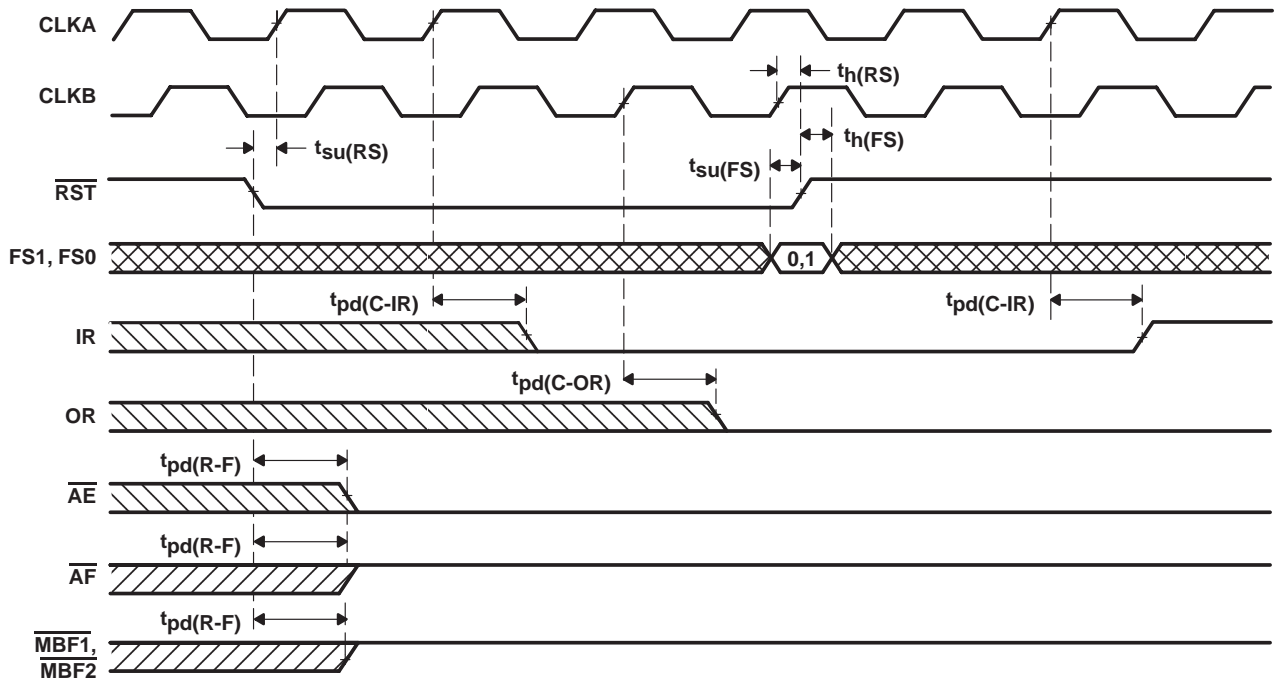
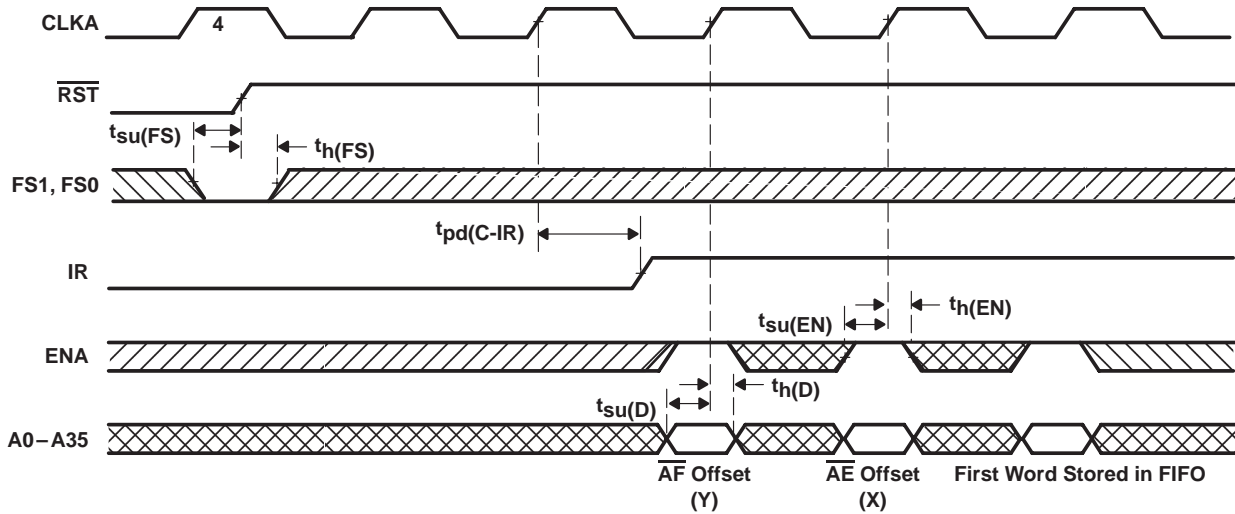

Figure 1. FIFO Reset Loading X and Y With a Preset Value of Eight

SN74ACT3651  
 2048 × 36  
 CLOCKED FIRST-IN, FIRST-OUT MEMORY  
 SCAS439D – JUNE 1994 – REVISED FEBRUARY 1999



NOTE A:  $\overline{CSA} = L, W/\overline{RA} = H, MBA = L$ . It is not necessary to program offset register on consecutive clock cycles.

Figure 2. Programming the  $\overline{AF}$  Flag and  $\overline{AE}$  Flag Offset Values From Port A

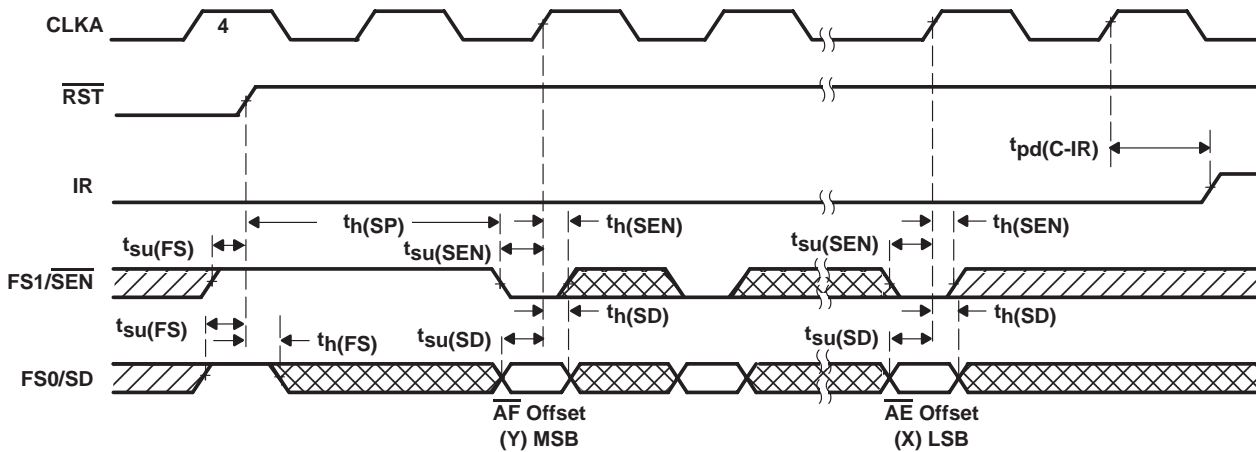

NOTE A: It is not necessary to program offset-register bits on consecutive clock cycles. FIFO write attempts are ignored until IR is set high.

Figure 3. Programming the  $\overline{AF}$  Flag and  $\overline{AE}$  Flag Offset Values Serially

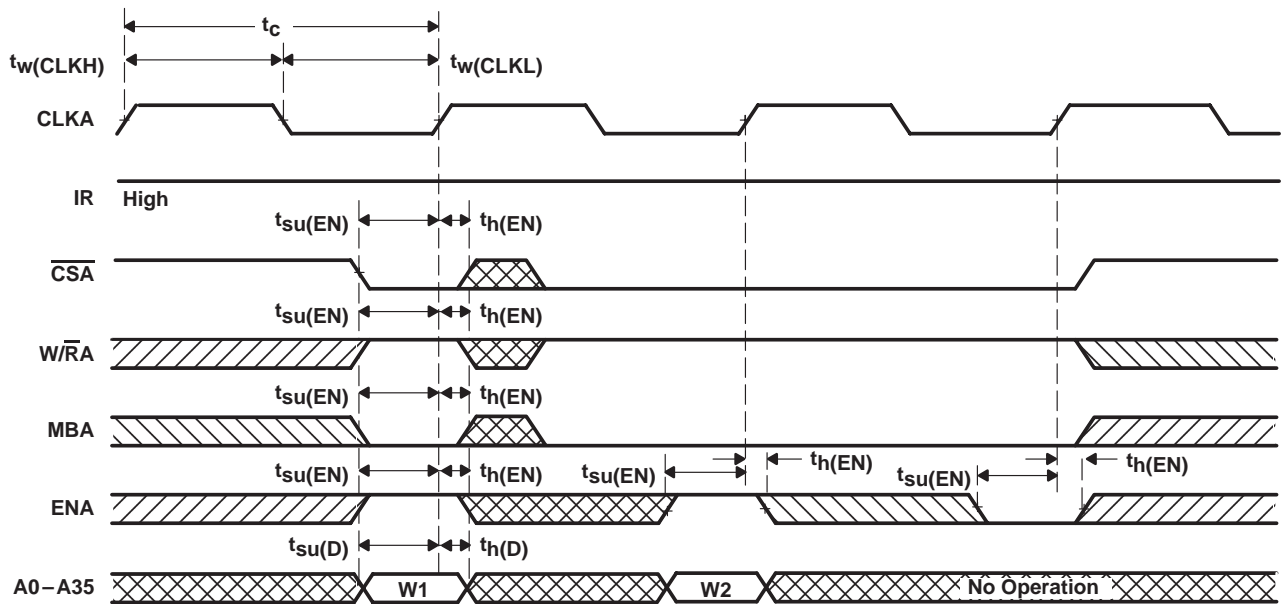

Figure 4. FIFO Write-Cycle Timing

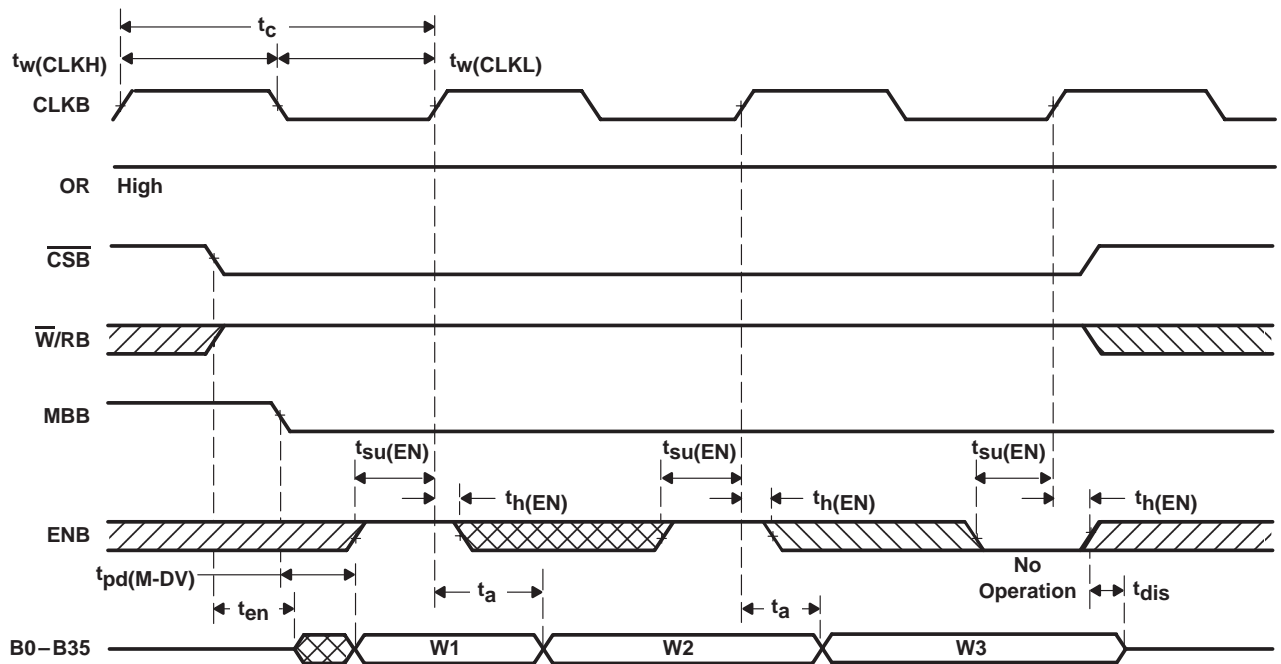
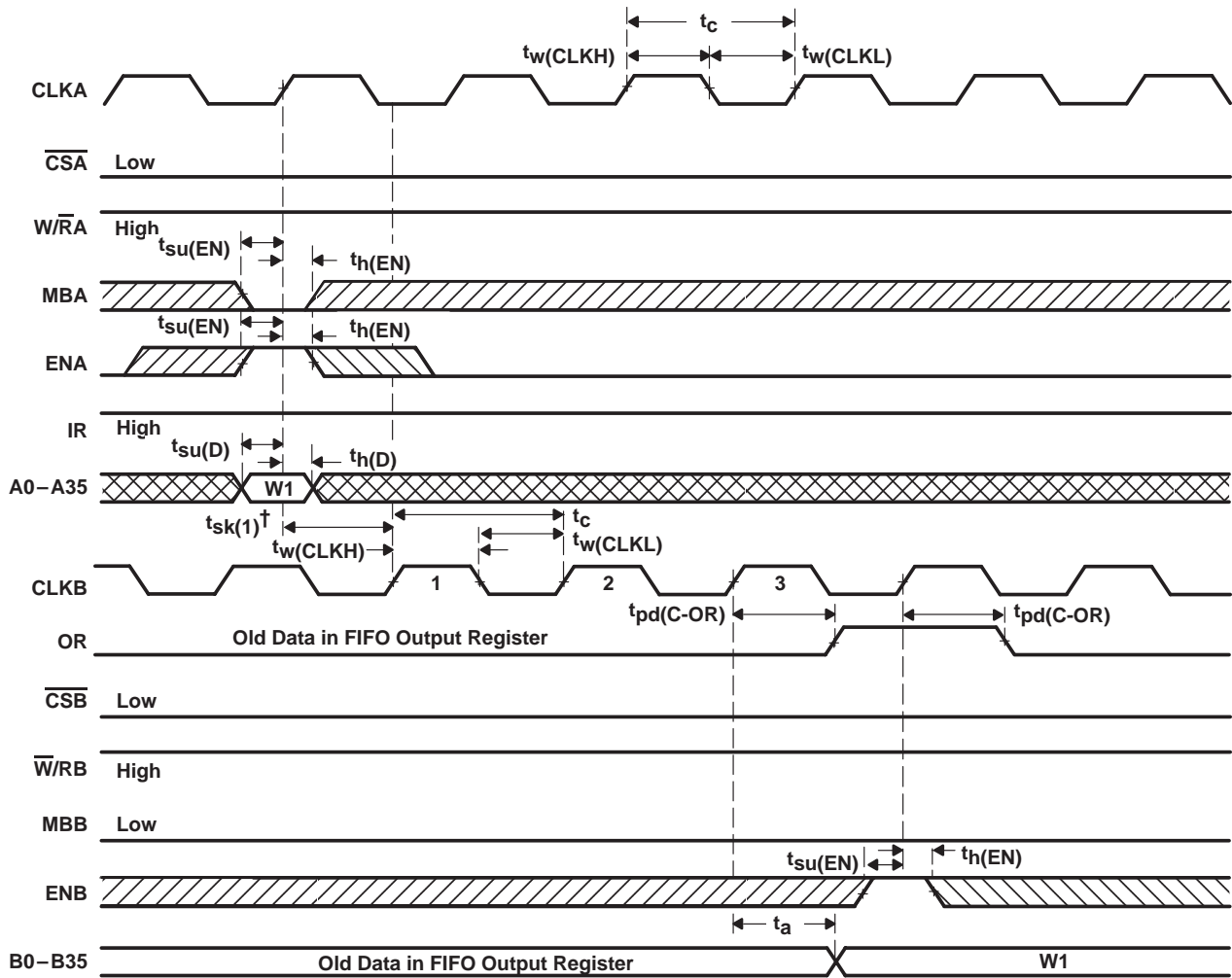

Figure 5. FIFO Read-Cycle Timing

SN74ACT3651  
 2048 × 36  
 CLOCKED FIRST-IN, FIRST-OUT MEMORY  
 SCAS439D – JUNE 1994 – REVISED FEBRUARY 1999



$^\dagger t_{sk}(1)$  is the minimum time between a rising CLKA edge and a rising CLKB edge for OR to transition high and to clock the next word to the FIFO output register in three CLKB cycles. If the time between the rising CLKA edge and rising CLKB edge is less than  $t_{sk}(1)$ , then the transition of OR high and the first word load to the output register can occur one CLKB cycle later than shown.

Figure 6. OR-Flag Timing and First-Data-Word Fall Through When the FIFO Is Empty

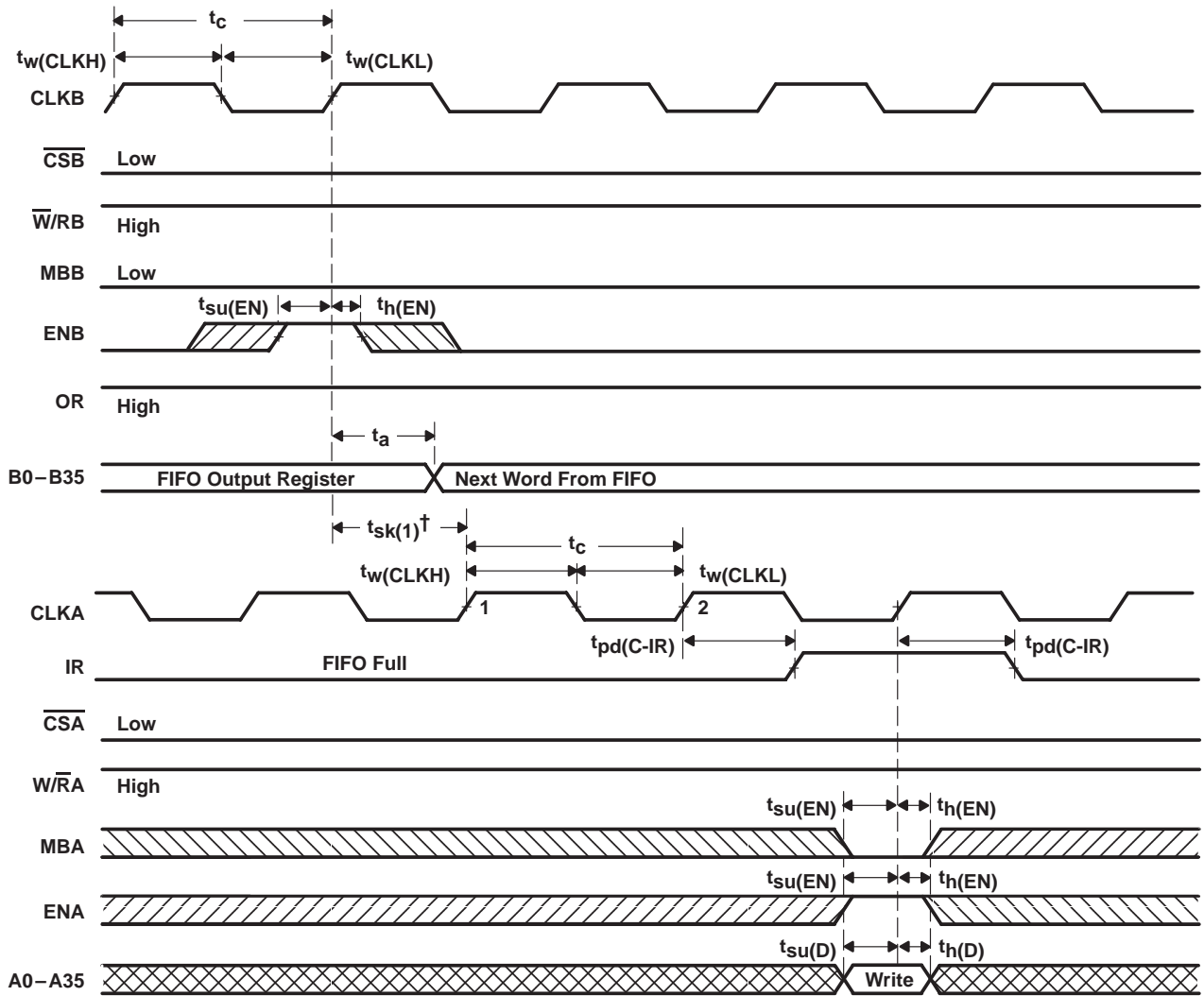

$^\dagger t_{sk}(1)$  is the minimum time between a rising CLKB edge and a rising CLKA edge for IR to transition high in the next CLKA cycle. If the time between the rising CLKB edge and rising CLKA edge is less than  $t_{sk}(1)$ , then IR can transition high one CLKA cycle later than shown.

**Figure 7. IR-Flag Timing and First Available Write When the FIFO Is Full**

SN74ACT3651  
 2048 × 36  
 CLOCKED FIRST-IN, FIRST-OUT MEMORY  
 SCAS439D – JUNE 1994 – REVISED FEBRUARY 1999

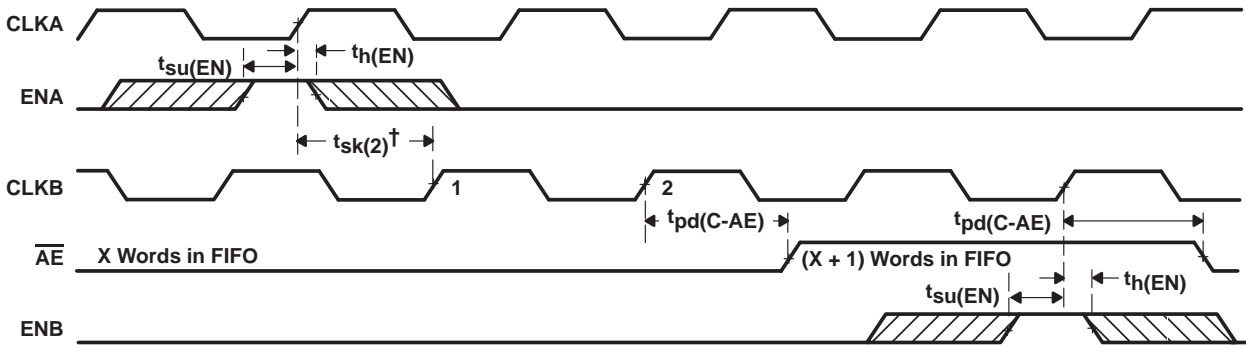

†  $t_{sk(2)}$  is the minimum time between a rising CLKA edge and a rising CLKB edge for  $\overline{A\bar{E}}$  to transition high in the next CLKB cycle. If the time between the rising CLKA edge and rising CLKB edge is less than  $t_{sk(2)}$ , then  $\overline{A\bar{E}}$  can transition high one CLKB cycle later than shown.  
 NOTE A: FIFO write ( $\overline{CSA} = L, \overline{W/RA} = H, \overline{MBA} = L$ ), FIFO read ( $\overline{CSB} = L, \overline{W/RB} = H, \overline{MBB} = L$ )

Figure 8. Timing for  $\overline{A\bar{E}}$  When FIFO Is Almost Empty

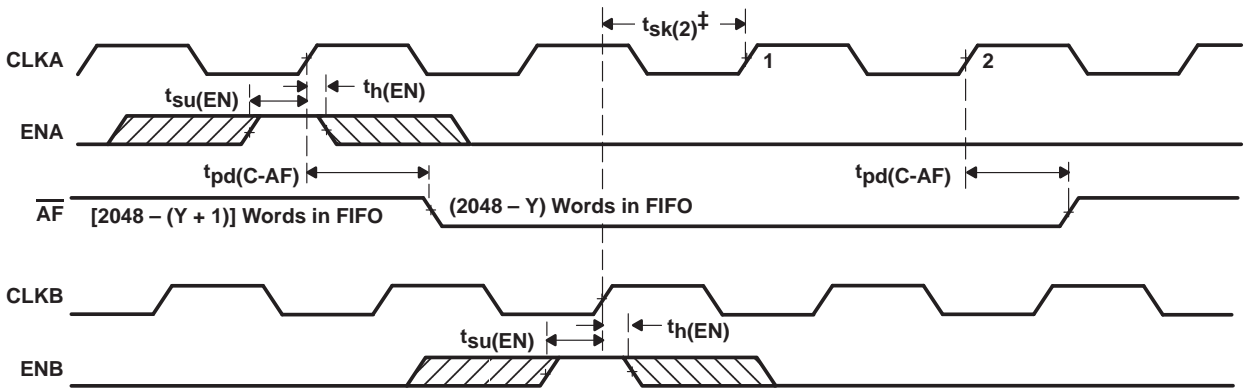

†  $t_{sk(2)}$  is the minimum time between a rising CLKB edge and a rising CLKA edge for  $\overline{A\bar{F}}$  to transition high in the next CLKA cycle. If the time between the rising CLKB edge and rising CLKA edge is less than  $t_{sk(2)}$ , then  $\overline{A\bar{F}}$  can transition high one CLKA cycle later than shown.  
 NOTE A: FIFO write ( $\overline{CSA} = L, \overline{W/RA} = H, \overline{MBA} = L$ ), FIFO read ( $\overline{CSB} = L, \overline{W/RB} = H, \overline{MBB} = L$ )

Figure 9. Timing for  $\overline{A\bar{F}}$  When FIFO Is Almost Full



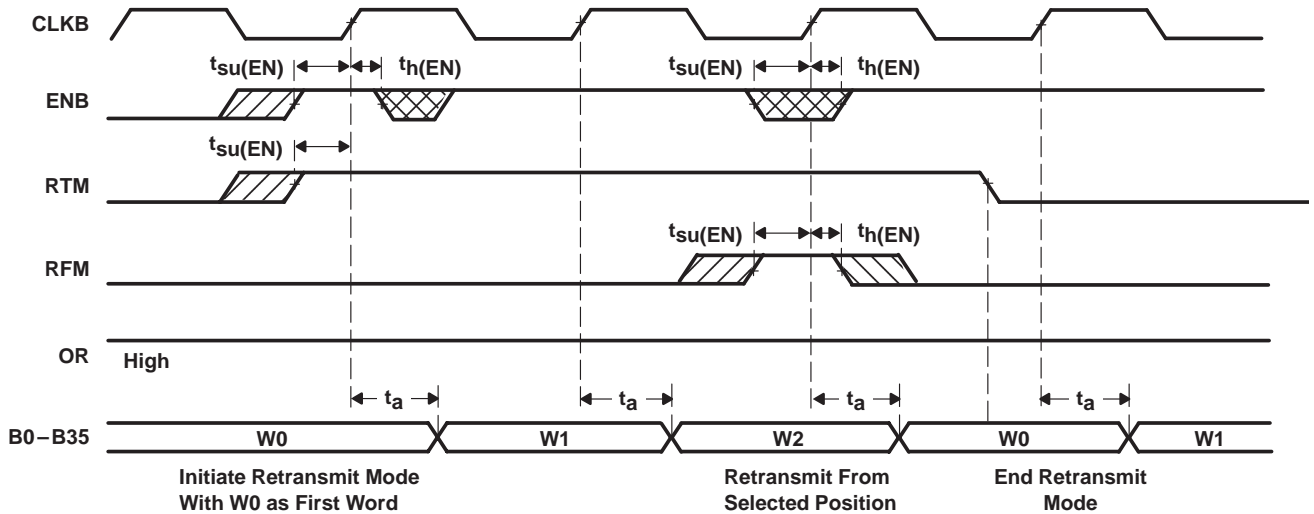

NOTE A:  $\overline{CSB} = L$ ,  $\overline{W/RB} = H$ ,  $MBB = L$ . No input enables other than RTM and RFM are needed to control retransmit mode or begin a retransmit. Other enables are shown only to relate retransmit operations to the FIFO output register.

**Figure 10. Retransmit Timing Showing Minimum Retransmit Length**

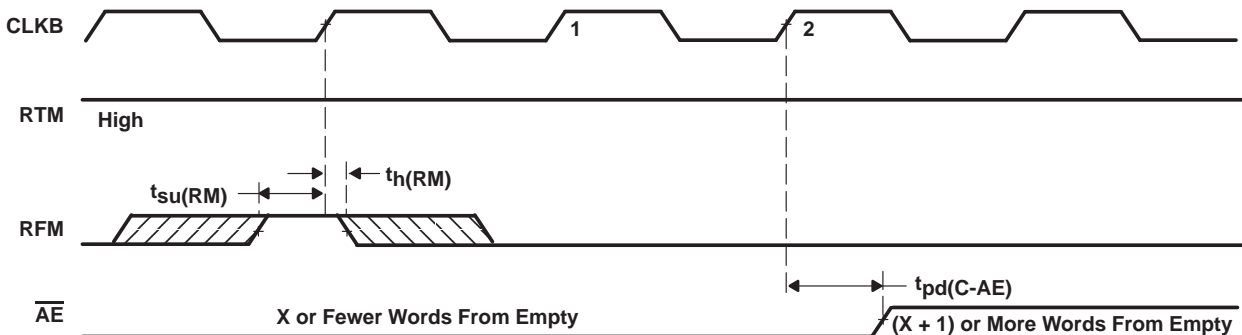

NOTE A: X is the value loaded in the  $\overline{AE}$ -flag offset register.

**Figure 11.  $\overline{AE}$  Maximum Latency When Retransmit Increases the Number of Stored Words Above X**

SN74ACT3651  
 2048 × 36  
 CLOCKED FIRST-IN, FIRST-OUT MEMORY

SCAS439D – JUNE 1994 – REVISED FEBRUARY 1999

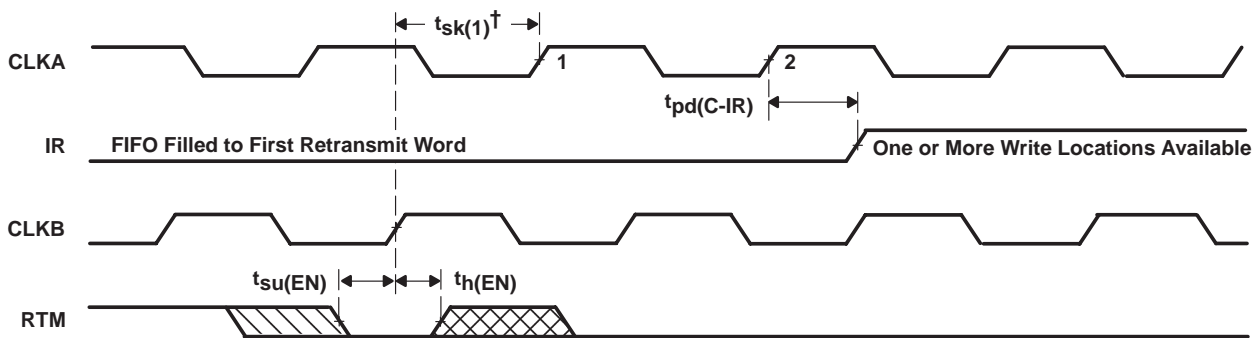

$\dagger t_{sk(1)}$  is the minimum time between a rising CLKB edge and a rising CLKA edge for IR to transition high in the next CLKA cycle. If the time between the rising CLKB edge and rising CLKA edge is less than  $t_{sk(1)}$ , then IR can transition high one CLKA cycle later than shown.

Figure 12. IR Timing From the End of Retransmit Mode When One or More Write Locations Are Available

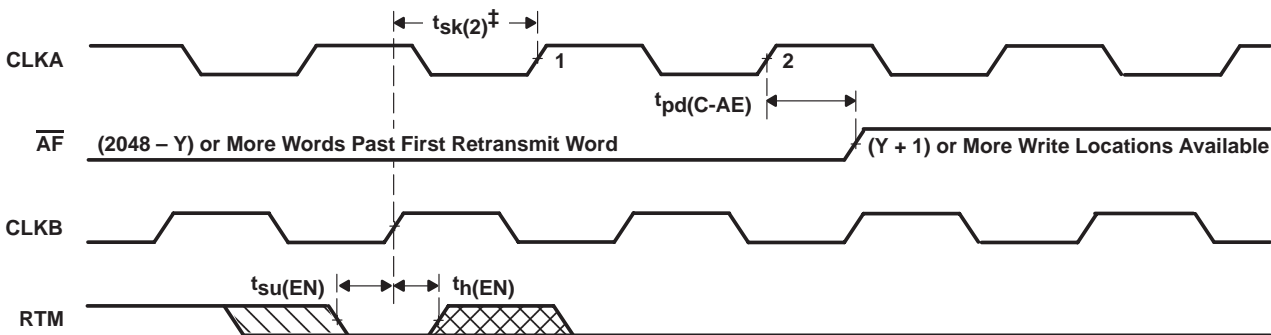

$\ddagger t_{sk(2)}$  is the minimum time between a rising CLKB edge and a rising CLKA edge for  $\overline{AF}$  to transition high in the next CLKA cycle. If the time between the rising CLKB edge and rising CLKA edge is less than  $t_{sk(2)}$ , then  $\overline{AF}$  can transition high one CLKA cycle later than shown.

NOTE A: Y is the value loaded in the AF flag offset register.

Figure 13.  $\overline{AF}$  Timing From the End of Retransmit Mode When (Y + 1) or More Write Locations Are Available

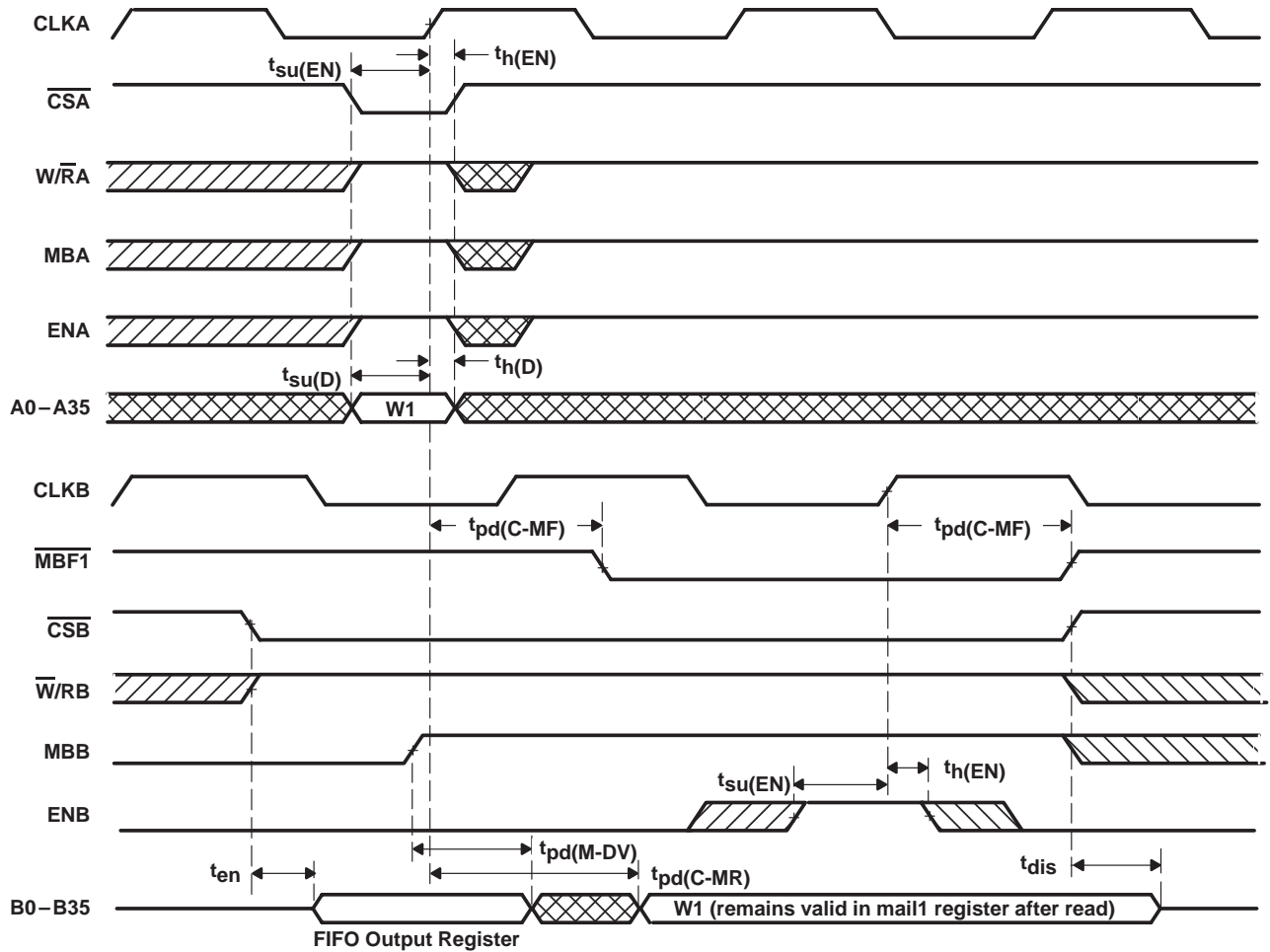

Figure 14. Timing for Mail1 Register and  $\overline{MBF1}$  Flag

SN74ACT3651  
 2048 × 36  
 CLOCKED FIRST-IN, FIRST-OUT MEMORY

SCAS439D – JUNE 1994 – REVISED FEBRUARY 1999

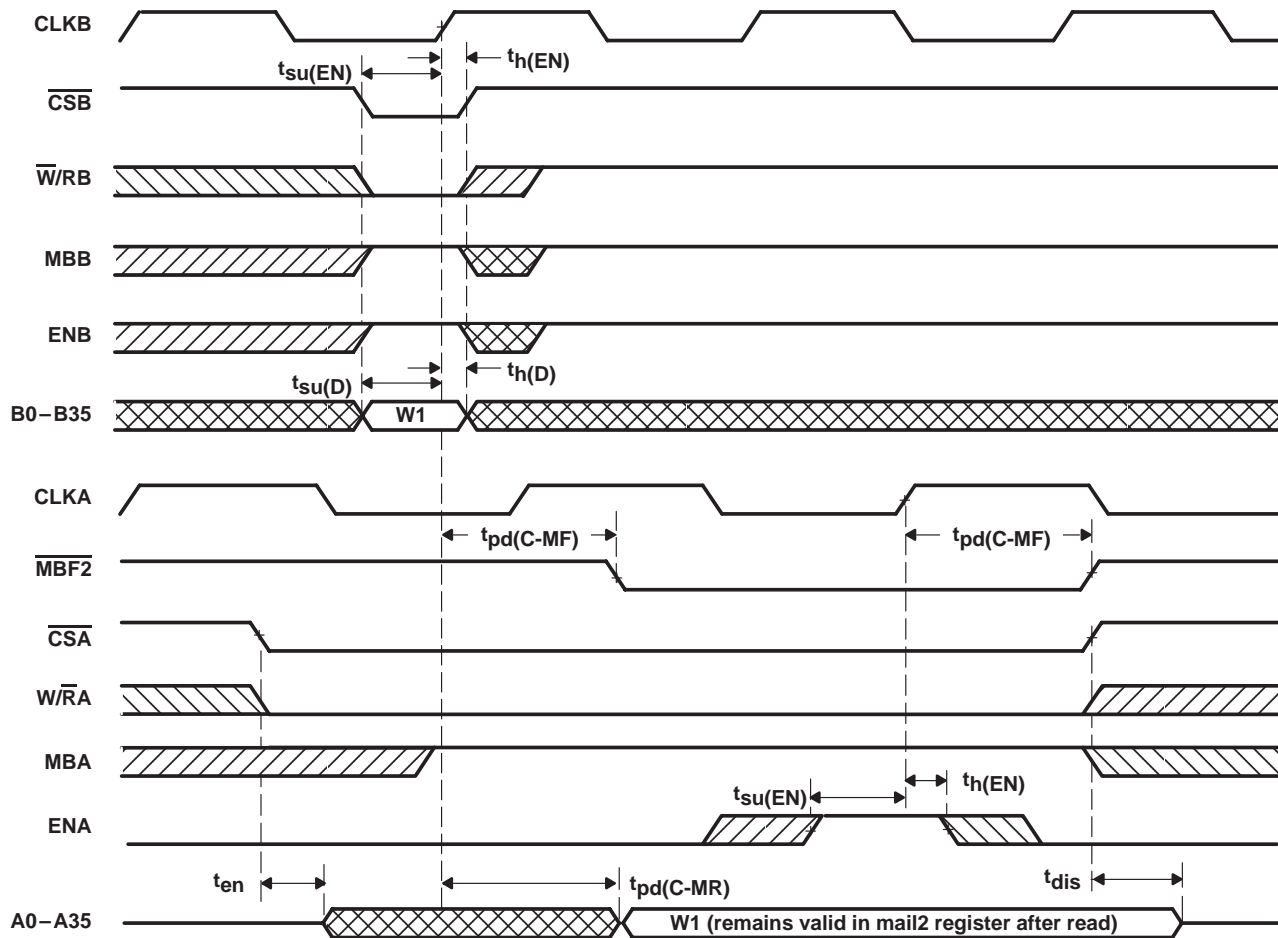

Figure 15. Timing for Mail2 Register and  $\overline{\text{MBF2}}$  Flag

**absolute maximum ratings over operating free-air temperature range (unless otherwise noted)†**

Supply voltage range, $V_{CC}$ .....	-0.5 V to 7 V
Input voltage range, $V_I$ (see Note 1) .....	-0.5 V to $V_{CC} + 0.5$ V
Output voltage range, $V_O$ (see Note 1) .....	-0.5 V to $V_{CC} + 0.5$ V
Input clamp current, $I_{IK}$ ( $V_I < 0$ or $V_I > V_{CC}$ ) .....	±20 mA
Output clamp current, $I_{OK}$ ( $V_O < 0$ or $V_O > V_{CC}$ ) .....	±50 mA
Continuous output current, $I_O$ ( $V_O = 0$ to $V_{CC}$ ) .....	±50 mA
Continuous current through $V_{CC}$ or GND .....	±400 mA
Package thermal impedance, $\theta_{JA}$ (see Note 2): PCB package .....	28°C/W
PQ package .....	46°C/W
Storage temperature range, $T_{stg}$ .....	-65°C to 150°C

† Stresses beyond those listed under "absolute maximum ratings" may cause permanent damage to the device. These are stress ratings only, and functional operation of the device at these or any other conditions beyond those indicated under "recommended operating conditions" is not implied. Exposure to absolute-maximum-rated conditions for extended periods may affect device reliability.

- NOTES: 1. The input and output voltage ratings may be exceeded provided the input and output current ratings are observed.  
2. The package thermal impedance is calculated in accordance with JESD 51.

**recommended operating conditions**

		MIN	MAX	UNIT
$V_{CC}$	Supply voltage	4.5	5.5	V
$V_{IH}$	High-level input voltage	2		V
$V_{IL}$	Low-level input voltage		0.8	V
$I_{OH}$	High-level output current		-4	mA
$I_{OL}$	Low-level output current		8	mA
$T_A$	Operating free-air temperature	0	70	°C

**electrical characteristics over recommended operating conditions (unless otherwise noted)**

PARAMETER	TEST CONDITIONS		MIN	TYP‡	MAX	UNIT
$V_{OH}$	$V_{CC} = 4.5$ V,	$I_{OH} = -4$ mA	2.4			V
$V_{OL}$	$V_{CC} = 4.5$ V,	$I_{OL} = 8$ mA			0.5	V
$I_I$	$V_{CC} = 5.5$ V,	$V_I = V_{CC}$ or 0			±5	µA
$I_{OZ}$	$V_{CC} = 5.5$ V,	$V_O = V_{CC}$ or 0			±5	µA
$I_{CC}$	$V_{CC} = 5.5$ V,	$V_I = V_{CC} - 0.2$ V or 0			400	µA
$\Delta I_{CC}$ §	$V_{CC} = 5.5$ V, One input at 3.4 V, Other inputs at $V_{CC}$ or GND	$\overline{CSA} = V_{IH}$	A0–A35	0		mA
		$\overline{CSB} = V_{IH}$	B0–B35	0		
		$\overline{CSA} = V_{IL}$	A0–A35		1	
		$\overline{CSB} = V_{IL}$	B0–B35		1	
		All other inputs			1	
$C_{i/o}$	$V_I = 0$ ,	$f = 1$ MHz		5		pF
$C_{control}$	$V_I = 0$ ,	$f = 1$ MHz		4		pF

‡ All typical values are at  $V_{CC} = 5$  V,  $T_A = 25^\circ\text{C}$ .

§ This is the supply current when each input is at one of the specified TTL voltage levels rather than 0 V or  $V_{CC}$  (at  $25^\circ\text{C}$ ).



**SN74ACT3651**  
**2048 × 36**  
**CLOCKED FIRST-IN, FIRST-OUT MEMORY**  
 SCAS439D – JUNE 1994 – REVISED FEBRUARY 1999

**timing requirements over recommended ranges of supply voltage and operating free-air temperature (see Figures 1 through 16)**

		'ACT3651-15		'ACT3651-20		'ACT3651-30		UNIT
		MIN	MAX	MIN	MAX	MIN	MAX	
$f_{\text{clock}}$	Clock frequency, CLKA or CLKB	66.7		50		33.4		MHz
$t_{\text{c}}$	Clock cycle time, CLKA or CLKB	15		20		30		ns
$t_{\text{w}}(\text{CH})$	Pulse duration, CLKA and CLKB high	6		8		12		ns
$t_{\text{w}}(\text{CL})$	Pulse duration, CLKA and CLKB low	6		8		12		ns
$t_{\text{su}}(\text{D})$	Setup time, A0–A35 before CLKA↑ and B0–B35 before CLKB↑	4		5		6		ns
$t_{\text{su}}(\text{EN})$	Setup time, $\overline{\text{CSA}}$ , $\overline{\text{W/RA}}$ , ENA, and MBA before CLKA↑; $\overline{\text{CSB}}$ , $\overline{\text{W/RB}}$ , ENB, MBB, RTM, and RFM before CLKB↑	4		5		6		ns
$t_{\text{su}}(\text{RS})$	Setup time, $\overline{\text{RST}}$ low before CLKA↑ or CLKB↑†	5		6		7		ns
$t_{\text{su}}(\text{FS})$	Setup time, FS0 and FS1 before $\overline{\text{RST}}$ high	12		13		14		ns
$t_{\text{su}}(\text{SD})^{\ddagger}$	Setup time, FS0/SD before CLKA↑	4		5		6		ns
$t_{\text{su}}(\text{SEN})^{\ddagger}$	Setup time, FS1/ $\overline{\text{SEN}}$ before CLKA↑	5		6		7		ns
$t_{\text{h}}(\text{D})$	Hold time, A0–A35 after CLKA↑ and B0–B35 after CLKB↑	1		1		1		ns
$t_{\text{h}}(\text{EN})$	Hold time, $\overline{\text{CSA}}$ , $\overline{\text{W/RA}}$ , ENA, and MBA after CLKA↑; $\overline{\text{CSB}}$ , $\overline{\text{W/RB}}$ , ENB, RFM, and MBB after CLKB↑	0		0		0		ns
$t_{\text{h}}(\text{RS})$	Hold time, $\overline{\text{RST}}$ low after CLKA↑ or CLKB↑†	5		6		7		ns
$t_{\text{h}}(\text{FS})$	Hold time, FS0 and FS1 after $\overline{\text{RST}}$ high	2		3		3		ns
$t_{\text{h}}(\text{SP})^{\ddagger}$	Hold time, FS1/ $\overline{\text{SEN}}$ high after $\overline{\text{RST}}$ high	1		1		1		ns
$t_{\text{h}}(\text{SD})^{\ddagger}$	Hold time, FS0/SD after CLKA↑	0		0		0		ns
$t_{\text{h}}(\text{SEN})^{\ddagger}$	Hold time, FS1/ $\overline{\text{SEN}}$ after CLKA↑	0		0		0		ns
$t_{\text{sk}}(1)^{\S}$	Skew time between CLKA↑ and CLKB↑ for OR and IR	6		8		10		ns
$t_{\text{sk}}(2)^{\S}$	Skew time between CLKA↑ and CLKB↑ for $\overline{\text{AE}}$ and $\overline{\text{AF}}$	12		16		20		ns

† Requirement to count the clock edge as one of at least four needed to reset a FIFO

‡ Applies only when serial load method is used to program flag offset registers

§ Skew time is not a timing constraint for proper device operation and is included only to illustrate the timing relationship between CLKA cycle and CLKB cycle.



switching characteristics over recommended ranges of supply voltage and operating free-air temperature,  $C_L = 30$  pF (see Figures 1 through 16)

PARAMETER	'ACT3651-15		'ACT3651-20		'ACT3651-30		UNIT
	MIN	MAX	MIN	MAX	MIN	MAX	
$f_{max}$	66.7		50		33.4		MHz
$t_a$ Access time, $CLKB\uparrow$ to B0–B35	3	11	3	13	3	15	ns
$t_{pd}(C-IR)$ Propagation delay time, $CLKA\uparrow$ to IR	1	8	1	10	1	12	ns
$t_{pd}(C-OR)$ Propagation delay time, $CLKB\uparrow$ to OR	1	8	1	10	1	12	ns
$t_{pd}(C-AE)$ Propagation delay time, $CLKB\uparrow$ to $\overline{AE}$	1	8	1	10	1	12	ns
$t_{pd}(C-AF)$ Propagation delay time, $CLKA\uparrow$ to $\overline{AF}$	1	8	1	10	1	12	ns
$t_{pd}(C-MF)$ Propagation delay time, $CLKA\uparrow$ to $\overline{MBF1}$ low or $\overline{MBF2}$ high and $CLKB\uparrow$ to MBF2 low or MBF1 high	0	8	0	10	0	12	ns
$t_{pd}(C-MR)$ Propagation delay time, $CLKA\uparrow$ to B0–B35 <sup>†</sup> and $CLKB\uparrow$ to A0–A35 <sup>‡</sup>	3	13	3	15	3	17	ns
$t_{pd}(M-DV)$ Propagation delay time, MBB to B0–B35 valid	3	10	3	12	3	14	ns
$t_{pd}(R-F)$ Propagation delay time, $\overline{RST}$ low to $\overline{AE}$ low and $\overline{AF}$ high	1	15	1	20	1	30	ns
$t_{en}$ Enable time, $\overline{CSA}$ and $\overline{W/RA}$ low to A0–A35 active and $\overline{CSB}$ low and $\overline{W/RB}$ high to B0–B35 active	2	13	2	15	2	17	ns
$t_{dis}$ Disable time, $\overline{CSA}$ or $\overline{W/RA}$ high to A0–A35 at high impedance and $\overline{CSB}$ high or $\overline{W/RB}$ low to B0–B35 at high impedance	1	13	1	15	1	17	ns

<sup>†</sup> Writing data to the mail1 register when the B0–B35 outputs are active and MBB is high

<sup>‡</sup> Writing data to the mail2 register when the A0–A35 outputs are active and MBA is high

PARAMETER MEASUREMENT INFORMATION

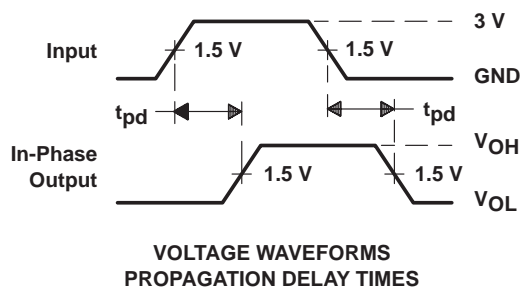
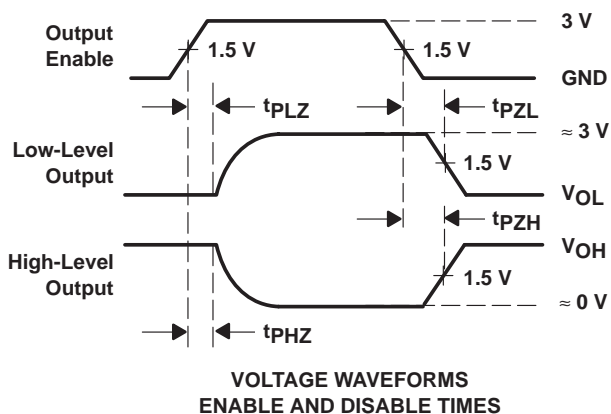
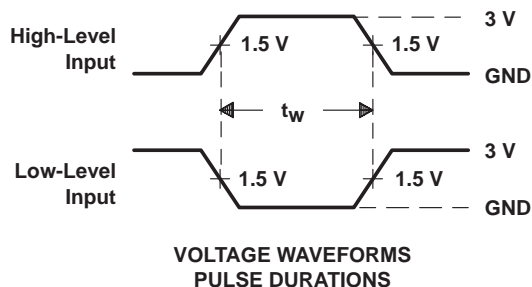
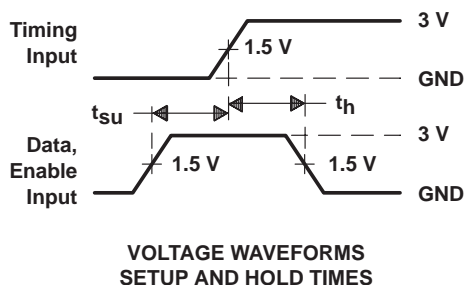
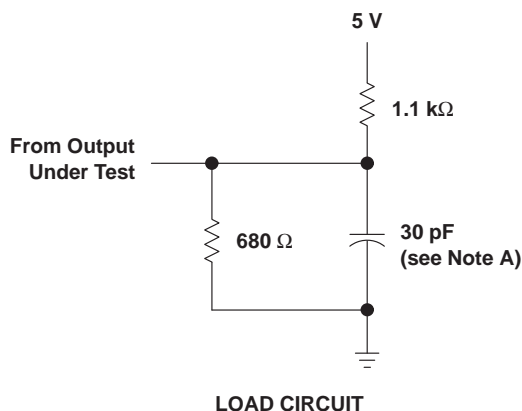

- NOTES: A. Includes probe and jig capacitance  
 B.  $t_{pZL}$  and  $t_{pZH}$  are the same as  $t_{en}$   
 C.  $t_{pLZ}$  and  $t_{pHZ}$  are the same as  $t_{dis}$

Figure 16. Load Circuit and Voltage Waveforms



TYPICAL CHARACTERISTICS

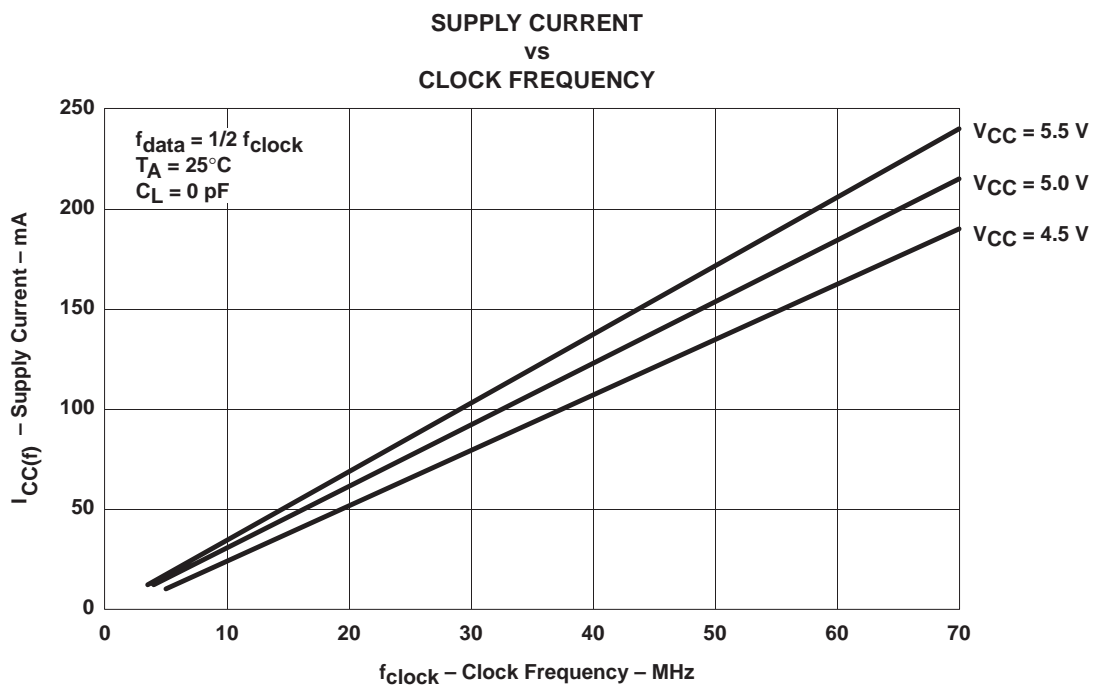

Figure 17

## **IMPORTANT NOTICE**

Texas Instruments and its subsidiaries (TI) reserve the right to make changes to their products or to discontinue any product or service without notice, and advise customers to obtain the latest version of relevant information to verify, before placing orders, that information being relied on is current and complete. All products are sold subject to the terms and conditions of sale supplied at the time of order acknowledgement, including those pertaining to warranty, patent infringement, and limitation of liability.

TI warrants performance of its semiconductor products to the specifications applicable at the time of sale in accordance with TI's standard warranty. Testing and other quality control techniques are utilized to the extent TI deems necessary to support this warranty. Specific testing of all parameters of each device is not necessarily performed, except those mandated by government requirements.

CERTAIN APPLICATIONS USING SEMICONDUCTOR PRODUCTS MAY INVOLVE POTENTIAL RISKS OF DEATH, PERSONAL INJURY, OR SEVERE PROPERTY OR ENVIRONMENTAL DAMAGE ("CRITICAL APPLICATIONS"). TI SEMICONDUCTOR PRODUCTS ARE NOT DESIGNED, AUTHORIZED, OR WARRANTED TO BE SUITABLE FOR USE IN LIFE-SUPPORT DEVICES OR SYSTEMS OR OTHER CRITICAL APPLICATIONS. INCLUSION OF TI PRODUCTS IN SUCH APPLICATIONS IS UNDERSTOOD TO BE FULLY AT THE CUSTOMER'S RISK.

In order to minimize risks associated with the customer's applications, adequate design and operating safeguards must be provided by the customer to minimize inherent or procedural hazards.

TI assumes no liability for applications assistance or customer product design. TI does not warrant or represent that any license, either express or implied, is granted under any patent right, copyright, mask work right, or other intellectual property right of TI covering or relating to any combination, machine, or process in which such semiconductor products or services might be or are used. TI's publication of information regarding any third party's products or services does not constitute TI's approval, warranty or endorsement thereof.