

TC217 1158- × 488-PIXEL CCD IMAGE SENSOR

SOCS015C – OCTOBER 1989 – REVISED JUNE 1996

- High-Resolution, Solid-State Monochrome Image Sensor for Video or Still-Picture Photography
- Frame Transfer With Two Field Memories Allows Multimode Operation
- 1134 (H) x 486 (V) Active Elements in Image-Sensing Area
- 11-mm Image-Area Diagonal is Compatible With 2/3" Vidicon Optics
- Fast Clear Capability
- Electron-Hole Recombination Antiblooming
- Dynamic Range . . . More Than 60 dB
- High Photoresponse Uniformity
- On-Chip Cross-Coupled Resets for Easy Off-Chip Implementation of CESH Video Signal Processing
- Solid-State Reliability With No Image Burn-in, Residual Imaging, Image Distortion, Image Lag, or Microphonics

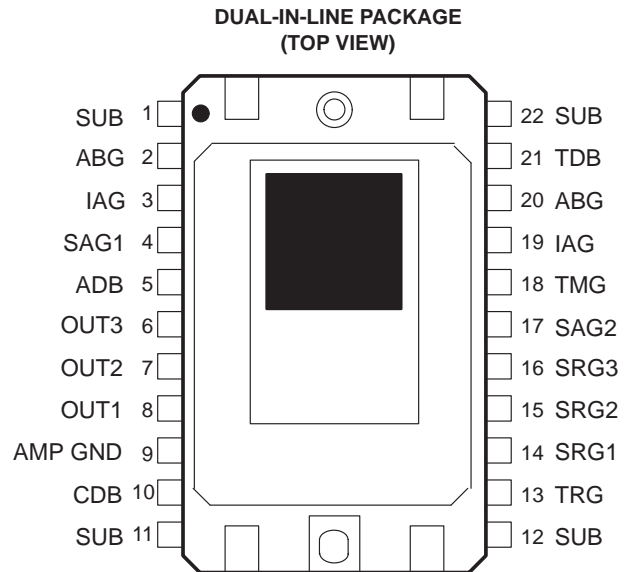

description

The TC217 is a frame-transfer charge-coupled-device (CCD) image sensor with two field memories. It is suitable for use in NTSC video or still-picture photography applications. Its image-sensing area is configured into 488 lines; 486 of these are active and the remaining two are used for dark reference. Each line is configured into 1158 pixels with 1134 active and 24 for dark reference. The TC217 has a standard aspect ratio of 4:3 and a standard 11-mm image-sensing-area diagonal. Its blooming protection, which is an integral part of each pixel, is based on electron-hole recombination and is activated by clocking the antiblooming gate.

One important aspect of the TC217 high-resolution sensor is its ability to simultaneously capture both fields of a TV frame. Its two independently addressable memories allow separate storage of each field and operation in a variety of modes, including EIA-170 (formerly RS-170) with true interlace, EIA-170 with pseudointerlace, and nonstandard pseudointerlace with a resolution of 972 lines.

A unique multiplexer section (see Figure 3) rearranges the horizontal pixels into vertical groups of three and separates and loads the image into the two field memories. The independent addressing of each field memory provides flexibility for different modes of operation. The interdigitated layout of the memories allows each memory to share the same bank of three serial registers and associated charge detection amplifiers (see Figure 4 and the functional block diagram). Each register and associated amplifier reads out every third column of the image area (see Figure 5). The three amplifiers are optimized dual source-followers that allow the use of off-chip double-correlated clamp-sample-and-hold amplifiers for removing KTC noise.

The TC217 is built using TI-proprietary virtual-phase technology, which provides devices with high blue response, low dark signal, good uniformity, and single-phase clocking. The TC217 is characterized for operation from -10°C to 40°C .



This MOS device contains limited built-in gate protection. During storage or handling, the device leads should be shorted together or the device should be placed in conductive foam. In a circuit, unused inputs should always be connected to SUB. Under no circumstances should pin voltages exceed absolute maximum ratings. Avoid shorting OUT_n to ADB during operation to prevent damage to the amplifier. The device can also be damaged if the output terminals are reverse-biased and an excessive current is allowed to flow. Specific guidelines for handling devices of this type are contained in the publication *Guidelines for Handling Electrostatic-Discharge-Sensitive (ESDS) Devices and Assemblies* available from Texas Instruments.

PRODUCTION DATA information is current as of publication date. Products conform to specifications per the terms of Texas Instruments standard warranty. Production processing does not necessarily include testing of all parameters.

 **TEXAS
INSTRUMENTS**

POST OFFICE BOX 655303 • DALLAS, TEXAS 75265

Copyright © 1996, Texas Instruments Incorporated

TC217 1158- × 488-PIXEL CCD IMAGE SENSOR

SOCS015C – OCTOBER 1989 – REVISED JUNE 1996

functional block diagram

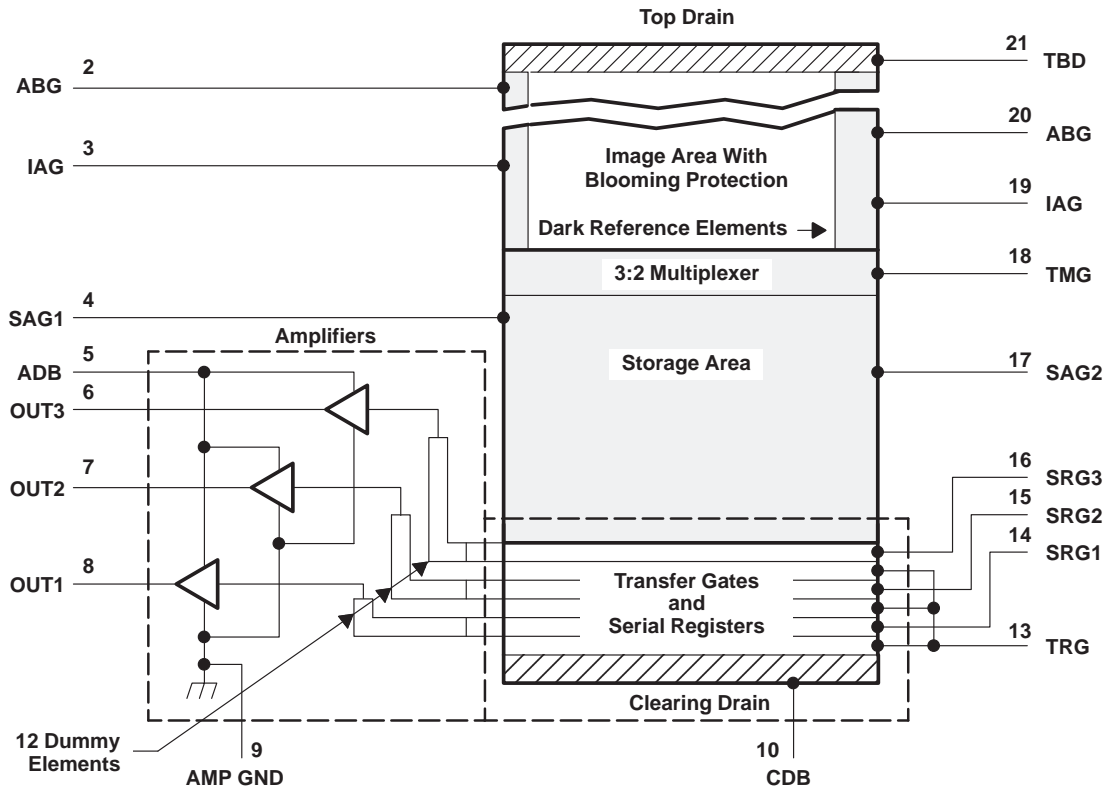

sensor topology diagram

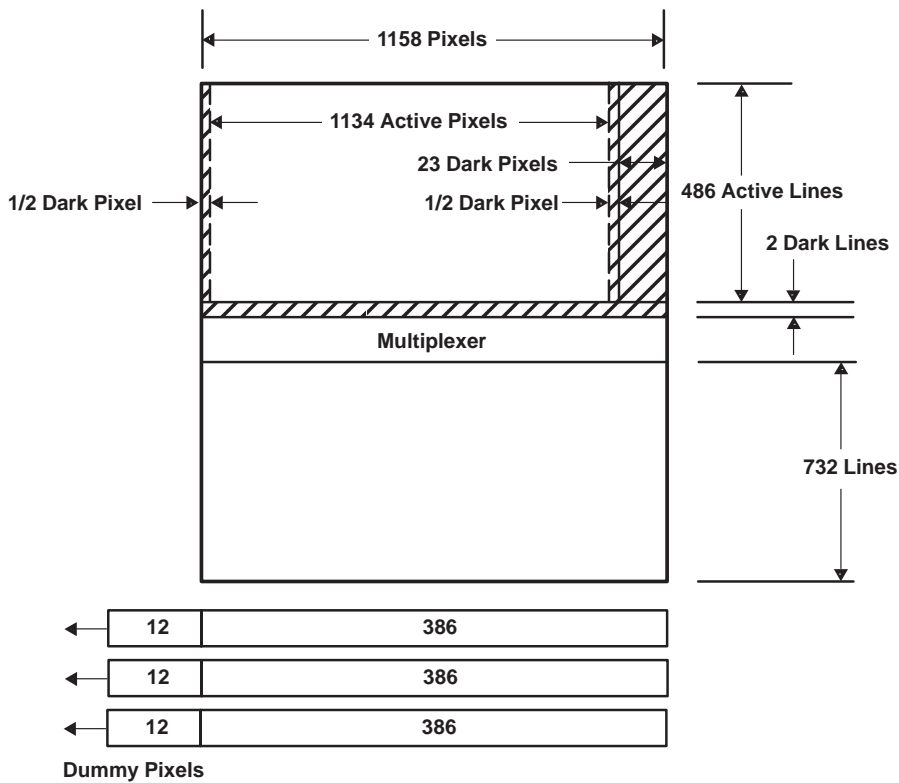

TC217 1158- × 488-PIXEL CCD IMAGE SENSOR

SOCS015C – OCTOBER 1989 – REVISED JUNE 1996

Terminal Functions

TERMINAL		I/O	DESCRIPTION
NAME	NO.		
ABG†	2	I	Antiblooming gate
ABG†	20	I	Antiblooming gate
ADB	5	I	Supply voltage for amplifier drain bias
AMP GND	9		Amplifier ground
CDB	10	I	Supply voltage for clearing drain bias
IAG†	3	I	Image-area gate
IAG†	19	I	Image-area gate
OUT1	8	O	Output signal 1
OUT2	7	O	Output signal 2
OUT3	6	O	Output signal 3
SAG1	4	I	Storage-area gate
SAG2	17	I	Storage-area gate
SRG1	14	I	Serial-register gate 1
SRG2	15	I	Serial-register gate 2
SRG3	16	I	Serial-register gate 3
SUB†	1		Substrate and clock return
SUB†	11		Substrate and clock return
SUB†	12		Substrate and clock return
SUB†	22		Substrate and clock return
TDB	21	I	Supply voltage for top drain bias
TMG	18	I	Transfer-multiplex gate
TRG	13	I	Transfer gate

† All pins of the same name should be connected together externally (i.e., pin 2 to pin 20, pin 3 to pin 19, etc.).

detailed description

The TC217 consists of five basic functional blocks: (1) the image-sensing area, (2) the multiplexer block, (3) the image-storage area with dual field memories, (4) the serial register and transfer gates, and (5) the low-noise signal-processing amplifier block with charge-detection nodes. The location of each of these blocks is identified in the functional block diagram.

image-sensing area

Figure 1 and Figure 2 show cross sections with potential well diagrams and top views of image-sensing elements. As light enters the silicon in the image-sensing area, free electrons are generated and collected in the potential wells of the sensing elements. During this time, blooming protection is activated by applying a burst of pulses to the antiblooming gate inputs every horizontal blanking interval. This prevents blooming caused by the spilling of charge from overexposed elements into neighboring elements. There are 23 full columns and one half-column of elements at the right edge of the image-sensing area that are shielded from incident light; these elements provide the dark reference used in subsequent video processing circuits to restore the video black level. There are also one half-column of light-shielded elements at the left edge of the image-sensing area and two lines of light-shielded elements at the bottom of the image area immediately above the multiplexer (the latter prevent charge leakage from the image area into the multiplexer).



POST OFFICE BOX 655303 • DALLAS, TEXAS 75265

multiplexer and storage area

After integration, the multiplexer rearranges two horizontal lines into vertical groups of three and separates and loads the image into the storage area. Figure 3 shows the layout of the multiplexer gate and its interface to the two field memories. Figure 4 shows the interface region between the storage area and the three serial registers. A drain is also provided to clear the image-sensing and image-storage areas of unwanted charge. Such charge can accumulate in the imager during the startup of operation or under special circumstances when nonstandard TV operation is desired. The sensor's independently addressable memories allow several different modes of sensor operation including (1) a normal-light mode, (2) a low-light mode, and (3) a still mode. The timing for these three modes is given in Figures 6, 7, and 8. The parallel-transfer timing is shown in Figure 9.

serial registers and amplifiers

After transfer to the serial registers (see Figure 10, which shows the horizontal timing that gives the necessary sequence of pulses for transfer from the storage area to the serial registers), the charge is converted to a signal voltage at the sense node and buffered with a dual-stage source follower. The three serial registers are typically clocked 120 degrees out of phase with each serial-gate pulse supplying a detection node reset signal for one of the other two serial gates. The readout timing, which includes the three serial pulses and the pixel clamp pulses used in an off-chip double-correlated sampling circuit, is shown in Figure 12. The detection nodes and amplifiers are located some distance away from the edge of the storage area. Therefore, 12 dummy elements are incorporated at the end of each serial register to span the distance. The location of the dummy elements, which are considered to be part of the amplifiers, is shown in the functional block diagram. A schematic of the detection node and amplifier is given in Figure 5.

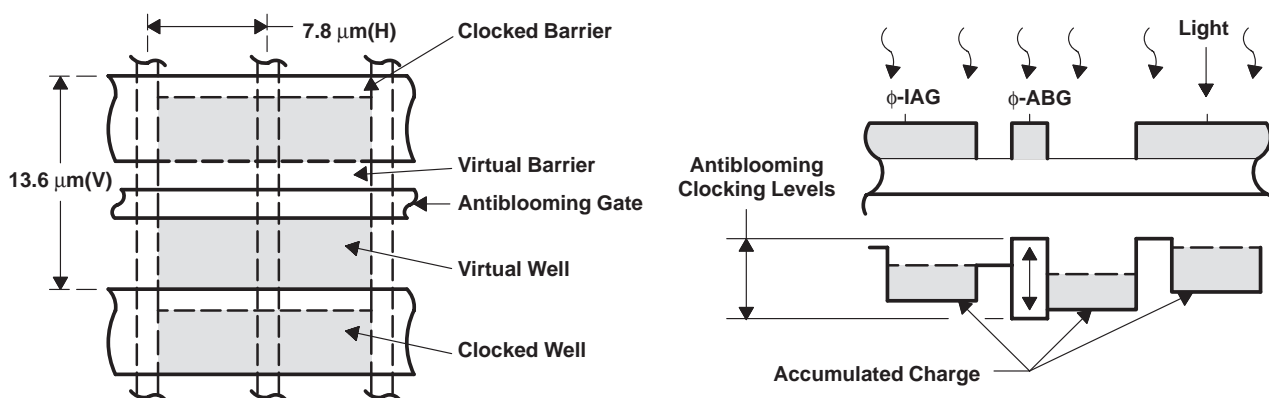

Figure 1. Charge-Accumulation Process

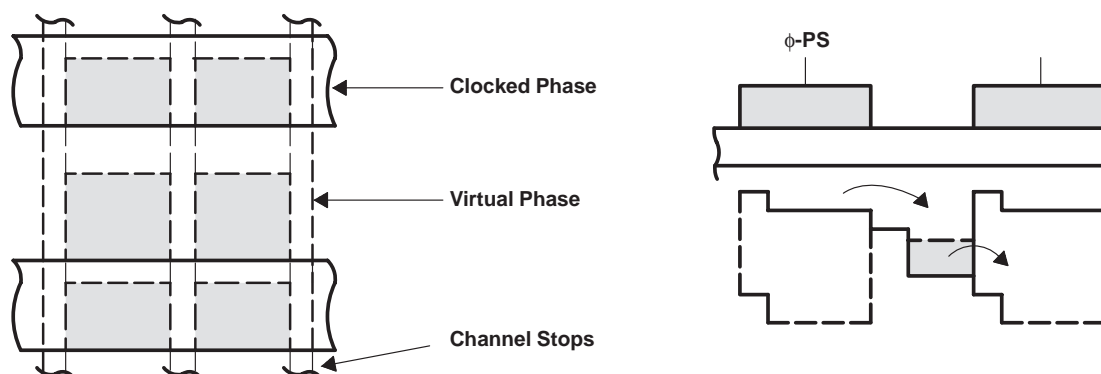

Figure 2. Charge-Transfer Process

TC217
 1158- × 488-PIXEL CCD IMAGE SENSOR

SOCS015C – OCTOBER 1989 – REVISED JUNE 1996

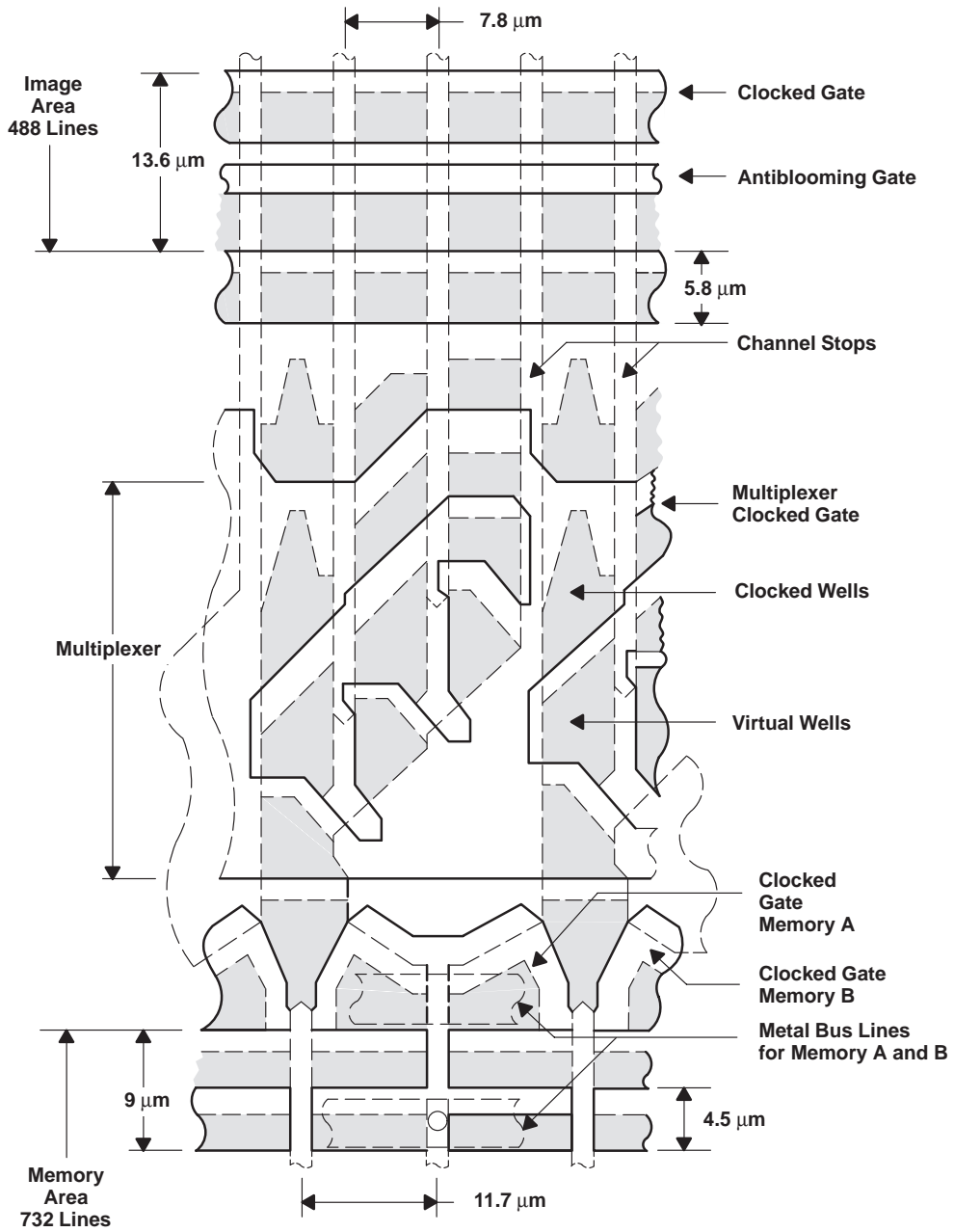

Figure 3. Layout of Multiplexing Gate

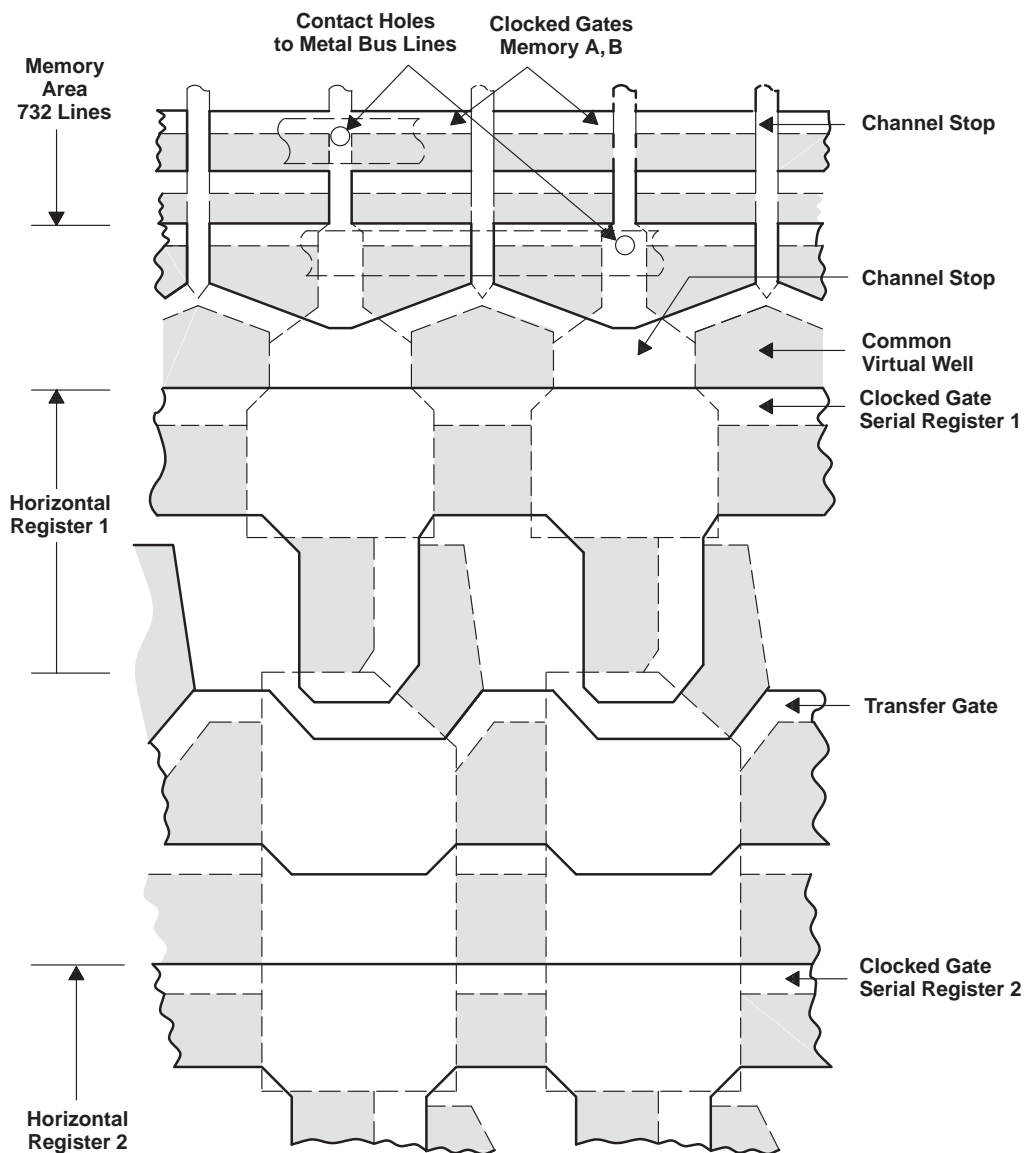

Figure 4. Layout of the Interface Region Between the Memories and the Serial Registers

TC217
1158- × 488-PIXEL CCD IMAGE SENSOR

SOCS015C – OCTOBER 1989 – REVISED JUNE 1996

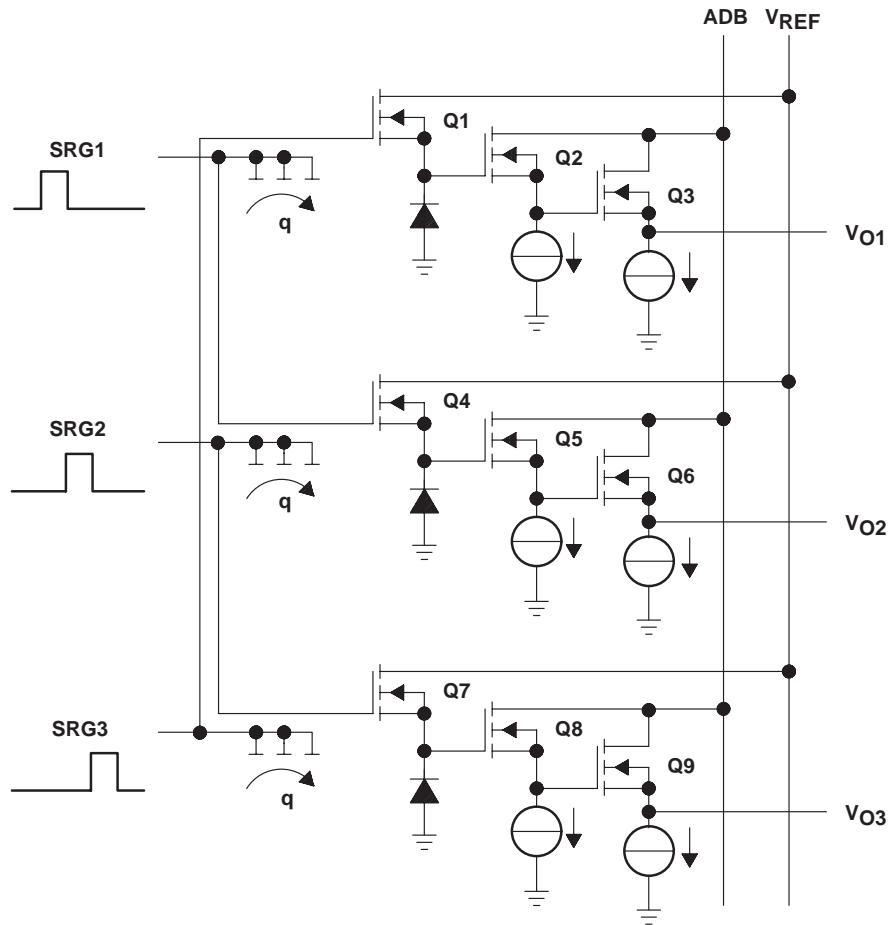

Figure 5. Circuit Diagram - Charge-Detection Amplifiers

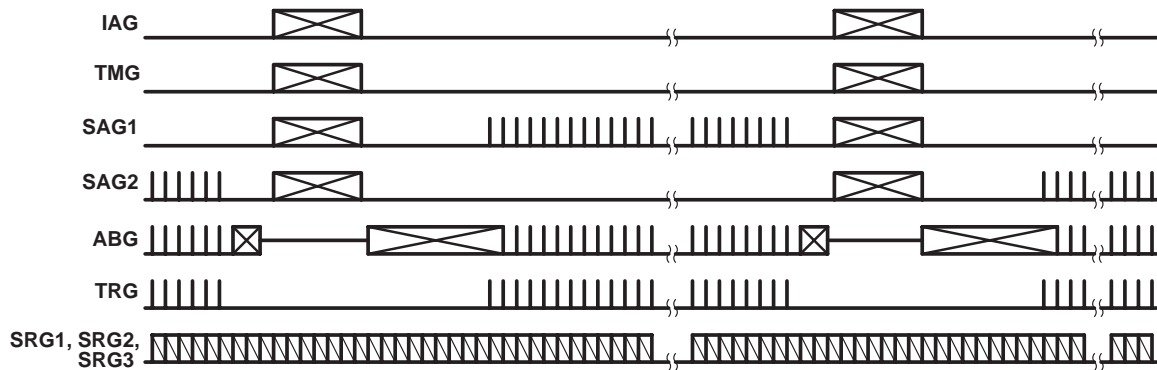

Figure 6. Vertical Timing, Normal-Light Mode

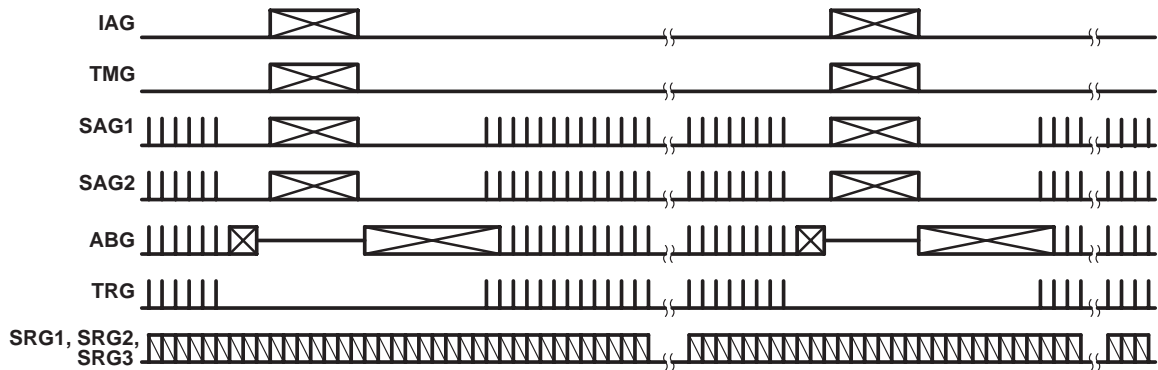

Figure 7. Vertical Timing, Low-Light Mode

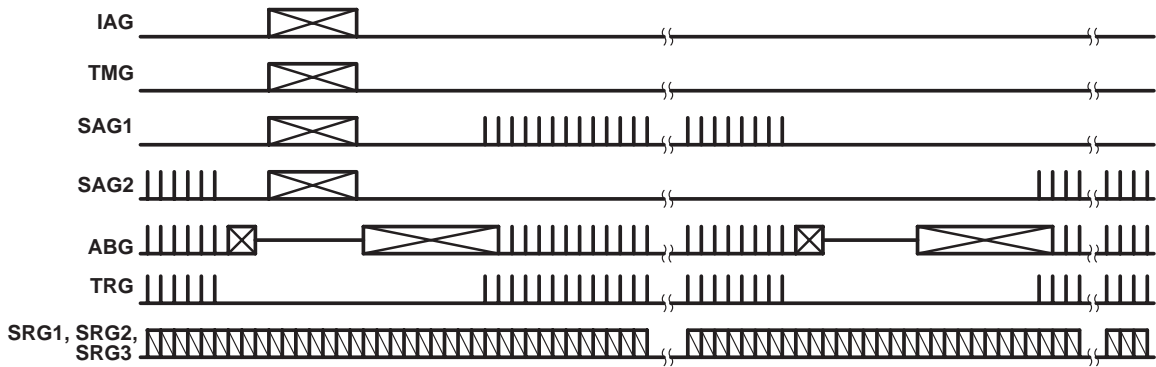

Figure 8. Vertical Timing, Still Mode

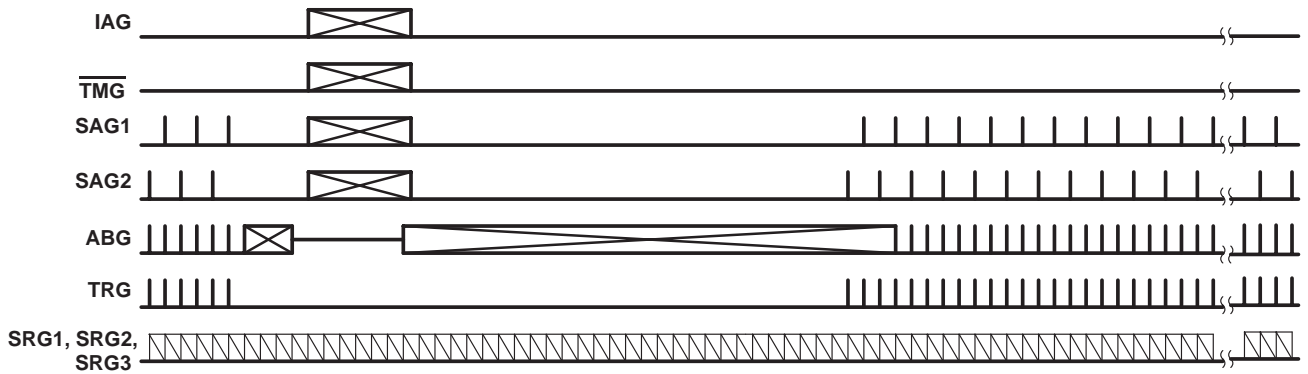

Figure 9. Vertical Timing, Progressive-Scan Mode

TC217
1158- × 488-PIXEL CCD IMAGE SENSOR

SOCS015C – OCTOBER 1989 – REVISED JUNE 1996

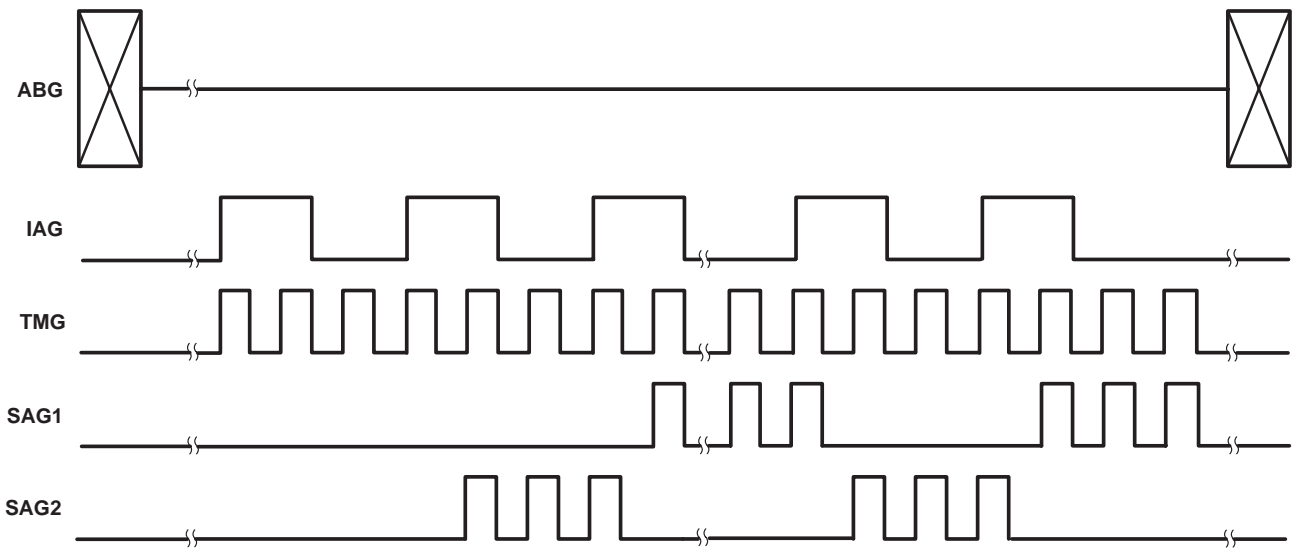
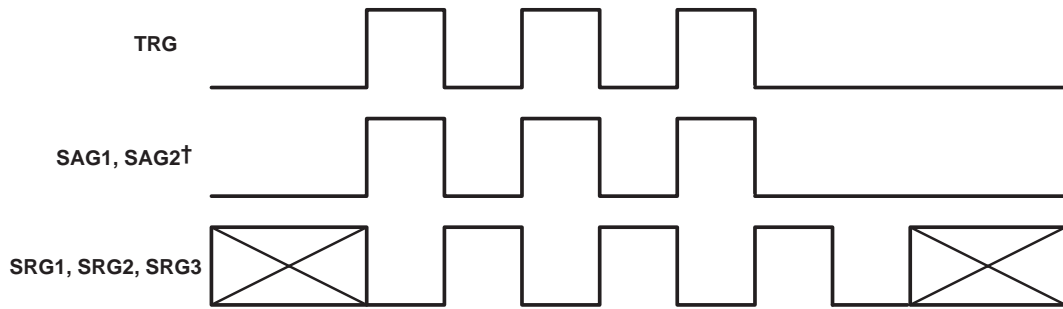

Figure 10. Parallel-Transfer Timing



† These clocks are mode-dependent.

Figure 11. Horizontal Timing

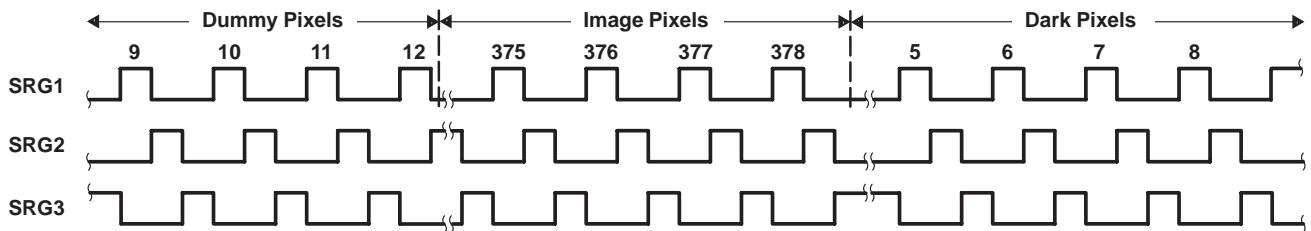
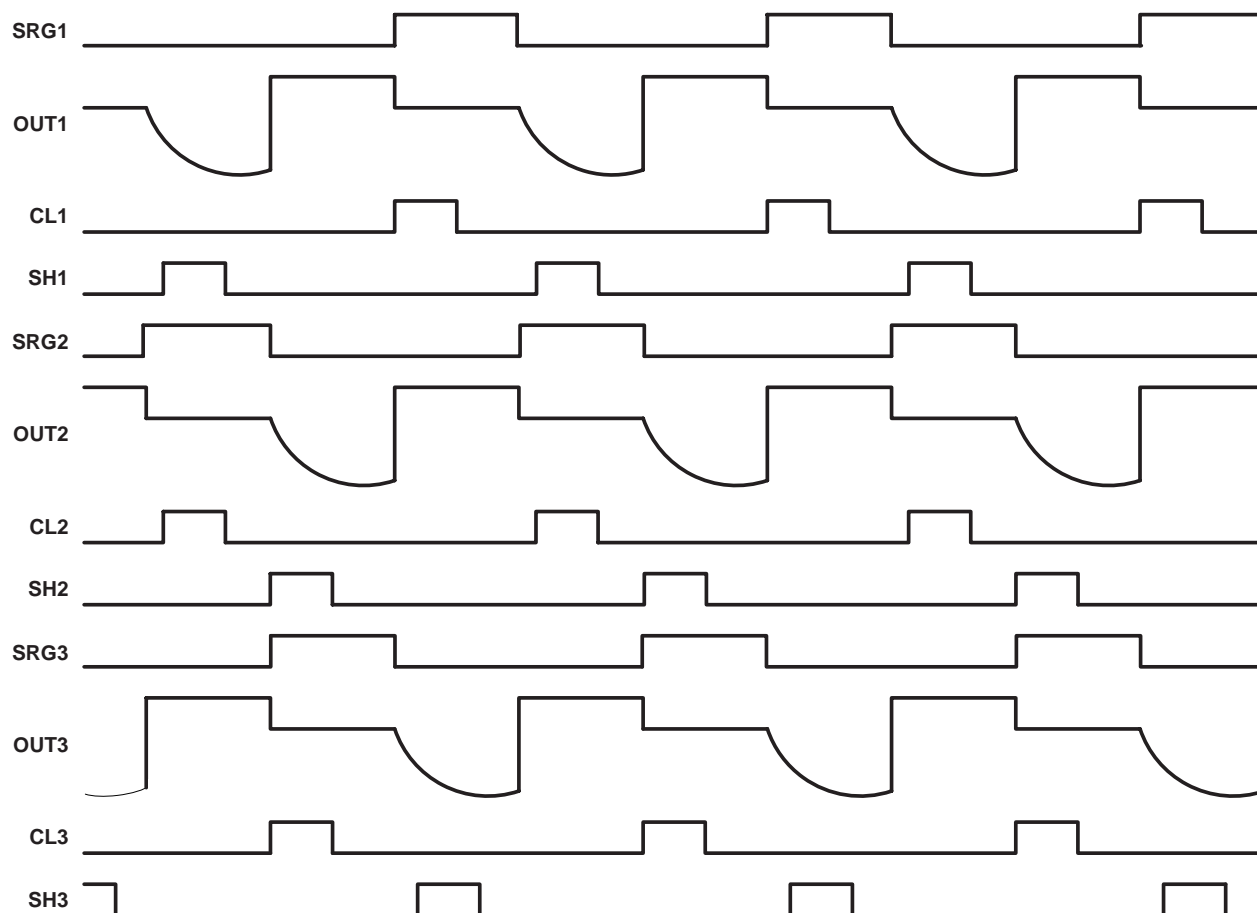

Figure 12. Start of Serial-Transfer Timing



- NOTES: A. The video-processing (off-chip) pulses are defined as follows:
 CL1 = Clamp pulse for video from OUT1
 SH1 = Sample pulse for the sample-and-hold amplifier for video 1
 CL2 = Clamp pulse for video from OUT2
 SH2 = Sample pulse for the sample-and-hold amplifier for video 2
 CL3 = Clamp pulse for video from OUT3
 SH3 = Sample pulse for the sample-and-hold amplifier for video 3
- B. The signals for channel (n+1) are phase shifted 120° from the signals for channel (n). For example, SRG2 is phase shifted 120° relative to SRG1, SRG3 is phase-shifted 120° relative to SRG2, OUT2 is phase shifted 120° relative to OUT1, OUT3 is phase shifted 120° relative to OUT2, and so forth.

Figure 13. Video-Process Timing

TC217 1158- × 488-PIXEL CCD IMAGE SENSOR

SOCS015C – OCTOBER 1989 – REVISED JUNE 1996

spurious nonuniformity specification

The spurious nonuniformity specification of the TC217 CCD grades –30 and –40 is based on several sensor characteristics:

- Amplitude of the nonuniform line or pixel
- Polarity of the nonuniform pixel
 - Black
 - White
- Column amplitude

The CCD sensors are characterized in both an illuminated condition and a dark condition. In the dark condition, the nonuniformity is specified in terms of absolute amplitude as shown in Figure 14. In the illuminated condition, the nonuniformity is specified as a percentage of the total illumination as shown in Figure 15.

The nonuniformity specification for the TC217 is as follows (CCD video-output signal is 50 mV ±10 mV):

PART NUMBER	PIXEL NONUNIFORMITY		COLUMN NONUNIFORMITY
	DARK CONDITION	ILLUMINATED CONDITION	COLUMN AMPLITUDE, x (mV)
	PIXEL AMPLITUDE, x (mV)	% OF TOTAL ILLUMINATION	
TC217-30	$x \leq 12 \text{ mV}$	$x \leq 10$	$x < 0.5 \text{ mV}$
TC217-40	$x \leq 15 \text{ mV}$	$x \leq 15$	$x \leq 1 \text{ mV}$

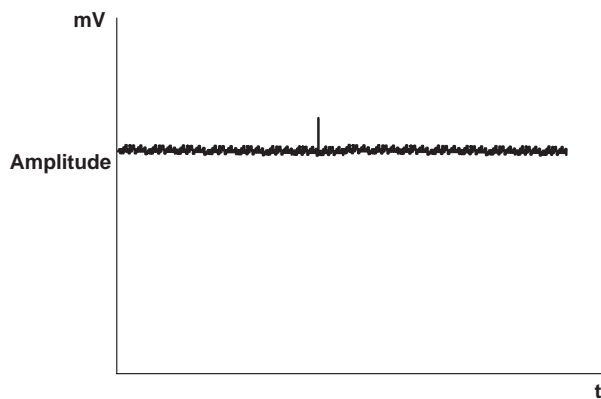

Figure 14. Pixel Nonuniformity, Dark Condition

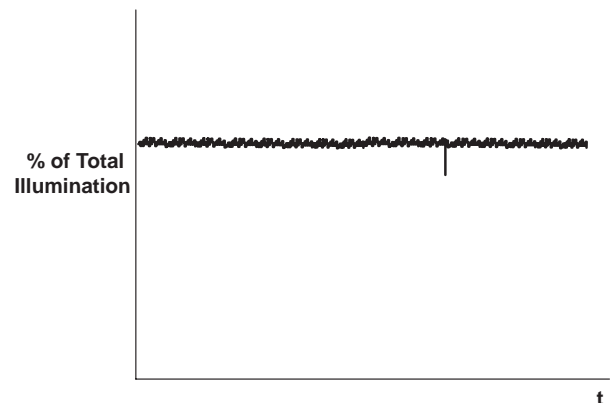

Figure 15. Pixel Nonuniformity, Illuminated Condition

absolute maximum ratings over operating free-air temperature range (unless otherwise noted)†

Supply voltage range for ADB, CDB, TDB (see Note 1)	0 V to 15 V
Input voltage range for ABG, IAG, SAG1, SAG2, SRG1, SRG2, SRG3, TRG	–15 V to 15 V
Operating free-air temperature range	–30°C to 85°C
Storage temperature range, T _A	–30°C to 85°C
Lead temperature 1,6 mm (1/16 inch) from case for 10 seconds	260°C

† Stresses beyond those listed under “absolute maximum ratings” may cause permanent damage to the device. These are stress ratings only, and functional operation of the device at these or any other conditions beyond those indicated under “recommended operating conditions” is not implied. Exposure to absolute-maximum-rated conditions for extended periods may affect device reliability.

NOTE 1: All voltage values are with respect to the substrate terminal.

recommended operating conditions

		MIN	NOM	MAX	UNIT	
Supply voltage for ADB, CDB, TDB		11	12	13	V	
Substrate bias voltage		0			V	
Input voltage, V _I ‡	IAG	High level	2	2.5	3	V
		Low level	–11		–9	
	SAG1, SAG2	High level	2	2.5	3	
		Low level	–11		–9	
	SRG1, SRG2, SRG3	High level	2	2.5	3	
		Low level	–11		–9	
	TMG	High level	2	2.5	3	
		Low level	–11		–9	
	ABG	High level	4	4.5	5	
		Intermediate level§	–2.85	–2	–1.55	
		Low level	–7.5	–7	–6.5	
	TRG	High level	2	2.5	3	
Low level		–11		–9		
Clock frequency, f _{clock}	ABG			1	MHz	
	IAG			1.2		
	SRG1, SRG2, SRG3, TRG			7.2		
	TMG, SAG1, SAG2			3.6		
Capacitive load	OUT1, OUT2, OUT3			8	pF	
Operating free-air temperature, T _A		–10		40	°C	

‡ The algebraic convention, in which the least-positive (most negative) value is designated minimum, is used in this data sheet for clock voltage levels.

§ Adjustment is required for optimal performance.



TC217

1158- × 488-PIXEL CCD IMAGE SENSOR

SOCS015C – OCTOBER 1989 – REVISED JUNE 1996

electrical characteristics over recommended operating ranges of supply voltage and free-air temperature

PARAMETER		MIN	TYP†	MAX	UNIT
Dynamic range (see Note 2)		60	73		dB
Charge conversion factor			6		μV/e
Charge transfer efficiency (see Note 3)		0.9999	0.99995		
Signal response delay time, τ (see Note 4 and Figure 18)		18	20	22	ns
Gamma (see Note 5)		0.89	0.94	0.99	
Output resistance			600	1000	Ω
Noise voltage	1/f noise (5 kHz)		0.1		μV/√Hz
	Random noise (f = 100 kHz)		0.08		
Noise equivalent signal			15		electrons
Rejection ratio at 4.77 MHz	ADB (see Note 6)		20		dB
	SRGn (see Note 7)		40		
	ABG (see Note 8)		30		
Supply current			6	9	mA
Input capacitance, C _i	IAG		13000		pF
	SAG1, SAG2		11000		
	ABG		4100		
	TMG		150		
	TRG		200		
	SRG1, SRG2, SRG3		180		

† All typical values are at T_A = 25 °C

- NOTES:
- Dynamic range is –20 times the logarithm of the mean noise signal divided by the saturation output signal. It is measured using a correlated clamp-sample-and-hold circuit and with the image sensor's antiblooming disabled.
 - Charge transfer efficiency is one minus the charge loss per transfer in the output register. The test is performed in the dark using an electrical input signal.
 - Signal-response delay time is the time between the falling edge of the SRG clock pulse and the output signal valid state.
 - Gamma (γ) is the value of the exponent in the equation below for two points on the linear portion of the transfer function curve:

$$\left(\frac{\text{Exposure (2)}}{\text{Exposure (1)}} \right)^\gamma = \left(\frac{\text{Output signal (2)}}{\text{Output signal (1)}} \right)$$

- ADB rejection ratio is –20 times the logarithm of the ac amplitude on OUTn divided by the ac amplitude on ADB.
- SRGn rejection ratio is –20 times the logarithm of the ac amplitude on OUTn divided by the ac amplitude on SRGn.
- ABG rejection ratio is –20 times the logarithm of the ac amplitude on OUTn divided by the ac amplitude on ABG.



POST OFFICE BOX 655303 • DALLAS, TEXAS 75265

TC217
1158- × 488-PIXEL CCD IMAGE SENSOR

SOCS015C – OCTOBER 1989 – REVISED JUNE 1996

optical characteristics, $T_A = 25^\circ\text{C}$, exposure time = 33 ms (unless otherwise noted)

PARAMETER		MIN	TYP	MAX	UNIT
Sensitivity (see Notes 9 and 10)	No IR filter		400		mV/lx
	With IR filter		50		
Saturation signal, V_{sat} (see Note 11)		320	410		mV
Image-area well capacity			60×10^3		electrons
Blooming overload ratio (see Note 12)	Exposure time = 1/60 second	150	200		
Smear (see Notes 13 and 14)				0.0012	
Output signal uniformity	$V_O = 1/2 V_U$ (see Note 10)			1	mV
Dark signal (see Note 15)	$T_A = 40^\circ\text{C}$		5	6	mV
Dark signal uniformity	$T_A = 40^\circ\text{C}$			0.3	mV
Dark current	$T_A = 21^\circ\text{C}$		0.027		nA/cm ²

- NOTES: 9. Sensitivity is measured at any illumination level that gives an output voltage level less than V_U . A CM-500 filter is used.
 10. V_U is the output voltage that represents the threshold of operation of antiblooming. $V_U \approx 1/2$ saturation signal.
 11. Saturation is the condition in which further increase in exposure does not lead to further increase in output signal.
 12. Blooming is the condition in which charge is induced in an element by light incident on another element. Blooming overload ratio is the ratio of blooming exposure to saturation exposure.
 13. Smear is the measure of error induced by transferring charge through an illuminated pixel in shutterless operation. It is equivalent to the ratio of the single-pixel transfer time during a fast dump to the exposure time using an illuminated section that is 1/10 of the image area vertical height with recommended clock frequencies.
 14. The fast-dump clocking rate during vertical timing is 1.2 MHz, and the illuminated section is 1/10 of the height of the image section.
 15. Dark-signal level is measured from the dark dummy pixels.



TC217
1158- × 488-PIXEL CCD IMAGE SENSOR

SOCS015C – OCTOBER 1989 – REVISED JUNE 1996

PARAMETER MEASUREMENT INFORMATION

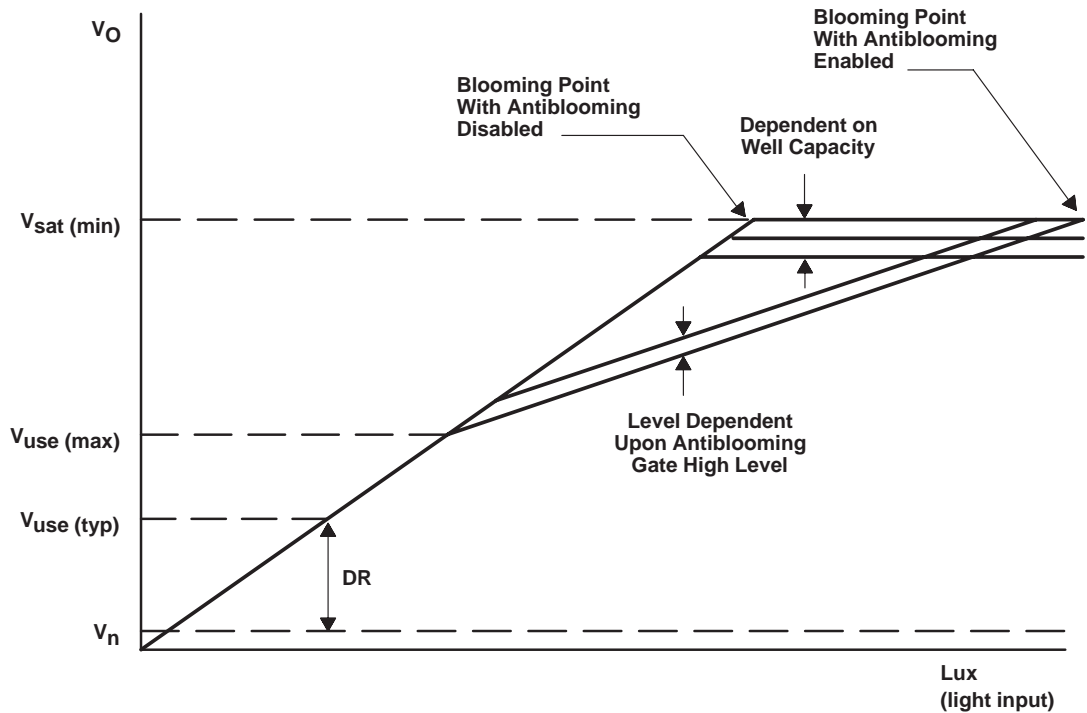

$$DR \text{ (dynamic range)} = \frac{\text{camera white clip voltage}}{V_n}$$

V_n = noise floor voltage

$V_{sat} \text{ (min)}$ = minimum saturation voltage

$V_{use} \text{ (max)}$ = maximum usable voltage

$V_{use} \text{ (typ)}$ = typical user voltage (camera white clip)

- NOTES: A. $V_{use} \text{ (typ)}$ is defined as the voltage determined to equal the camera white clip. This voltage must be less than $V_{use} \text{ (max)}$.
 B. A system trade-off is necessary to determine the system light sensitivity versus the signal/noise ratio. By lowering the $V_{use} \text{ (typ)}$, the light sensitivity of the camera is increased; however, this sacrifices the signal/noise ratio of the camera.

Figure 16. Typical V_{sat} , V_{use} Relationship

PARAMETER MEASUREMENT INFORMATION

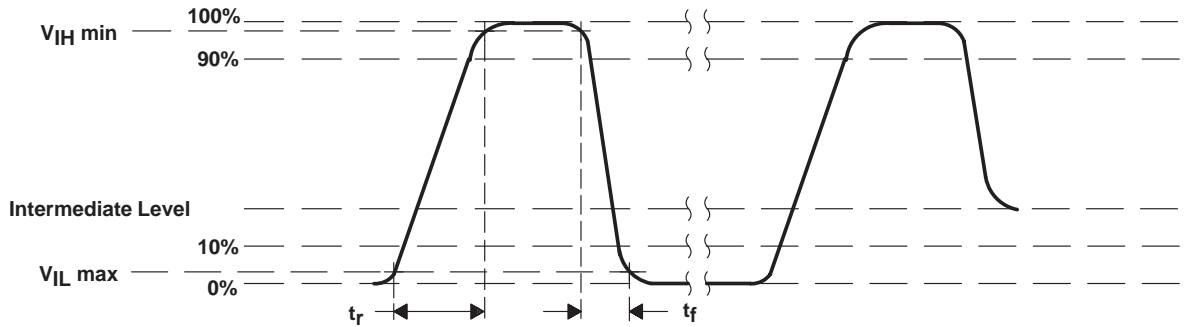

Slew rate between 10% and 90% = 70 to 120 V/ μ s, t_r = 150 ns, t_f = 90 ns

Figure 17. Typical Clock Waveform for ABG, IAG, SAG1, SAG2, AND TMG

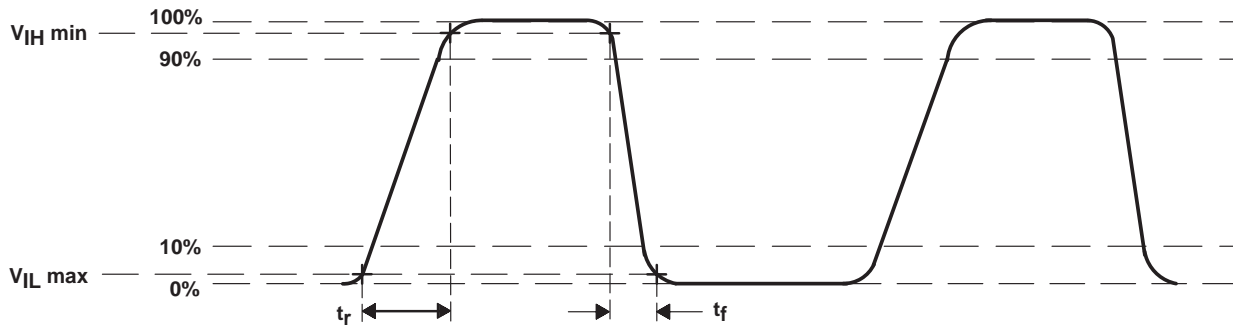

Slew rate between 10% and 90% = 300 V/ μ s, t_r = t_f = 15 ns

Figure 18. Typical Clock Waveform for SRG1, SRG2, SRG3, and TRG

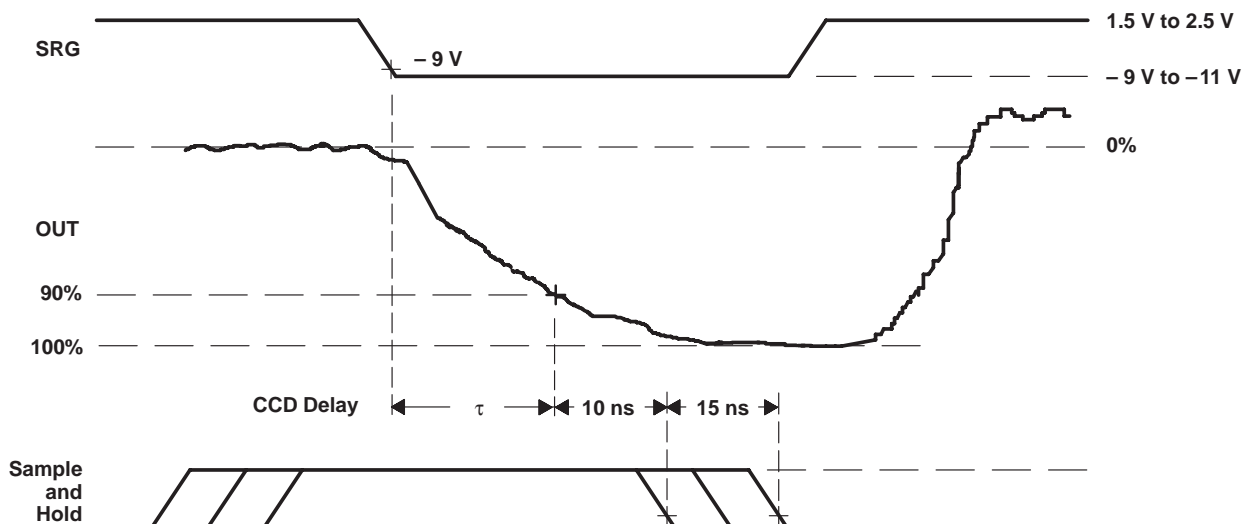
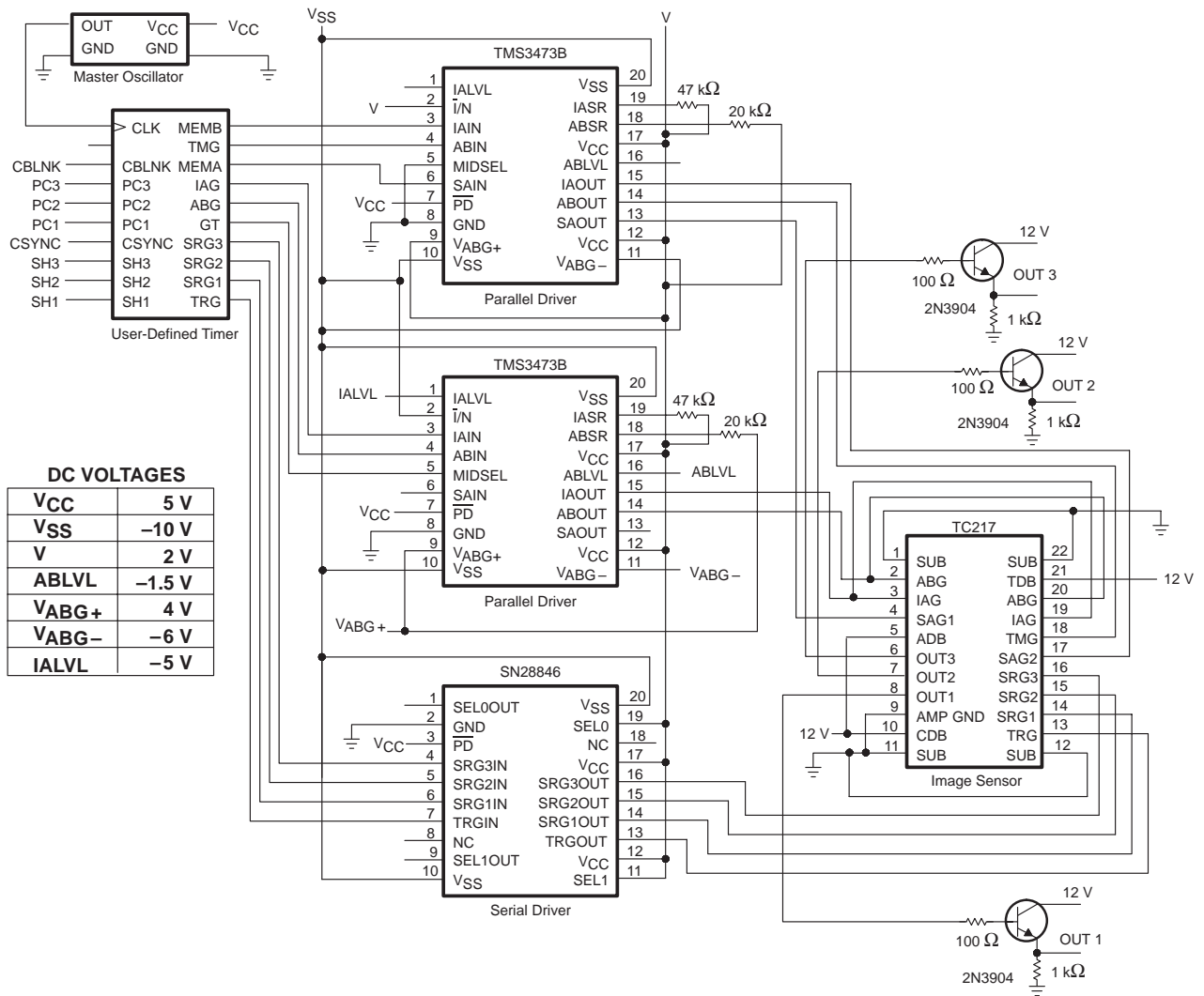

Figure 19. SRG and OUT Waveforms

TC217 1158- × 488-PIXEL CCD IMAGE SENSOR

SOCS015C – OCTOBER 1989 – REVISED JUNE 1996

APPLICATION INFORMATION



SUPPORT CIRCUITS

DEVICE	PACKAGE	APPLICATION	FUNCTION
SN28846DW	20 pin small outline	Serial driver	Driver for SRG1, SRG2, SRG3, and TRG
TMS3473BDW	20 pin small outline	Parallel driver	Driver for IAG, SAG1, SAG2, ABG, and TMG

Figure 20. Typical Application Circuit Diagram

TC217 1158- × 488-PIXEL CCD IMAGE SENSOR

SOCS015C – OCTOBER 1989 – REVISED JUNE 1996

MECHANICAL DATA

The package for the TC217 consists of a ceramic base, a glass window, and a 22-lead frame. The package leads are configured in a dual in-line organization and fit into mounting holes with 2.54 mm (0.10 inch) center-to-center spacings. The glass window is sealed to the package by an epoxy adhesive. It can be cleaned by any standard procedure for cleaning optical assemblies or by wiping the surface with a cotton swab moistened with alcohol.

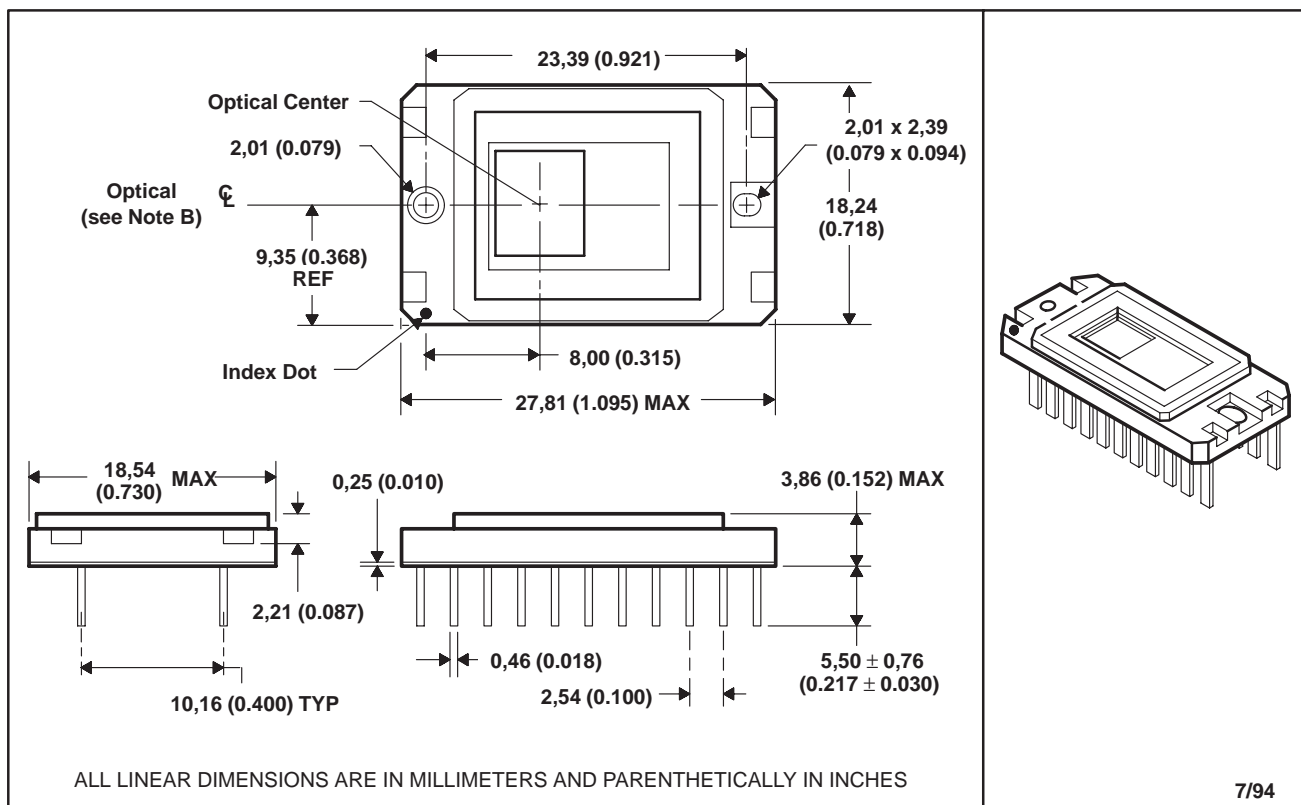

- NOTES: A. Single dimensions are nominal.
 B. The center of the package and the center of the image area are not coincident.
 C. The distance from the top of the glass to the image sensor surface is typically 1,46 mm (0.057 inch). The glass is 0,95 ± 0,08 mm and has an index of refraction of 1.53.
 D. Each pin centerline is located within 0,25 mm (0.010 inch) of its true longitudinal position.

IMPORTANT NOTICE

Texas Instruments and its subsidiaries (TI) reserve the right to make changes to their products or to discontinue any product or service without notice, and advise customers to obtain the latest version of relevant information to verify, before placing orders, that information being relied on is current and complete. All products are sold subject to the terms and conditions of sale supplied at the time of order acknowledgement, including those pertaining to warranty, patent infringement, and limitation of liability.

TI warrants performance of its semiconductor products to the specifications applicable at the time of sale in accordance with TI's standard warranty. Testing and other quality control techniques are utilized to the extent TI deems necessary to support this warranty. Specific testing of all parameters of each device is not necessarily performed, except those mandated by government requirements.

CERTAIN APPLICATIONS USING SEMICONDUCTOR PRODUCTS MAY INVOLVE POTENTIAL RISKS OF DEATH, PERSONAL INJURY, OR SEVERE PROPERTY OR ENVIRONMENTAL DAMAGE ("CRITICAL APPLICATIONS"). TI SEMICONDUCTOR PRODUCTS ARE NOT DESIGNED, AUTHORIZED, OR WARRANTED TO BE SUITABLE FOR USE IN LIFE-SUPPORT DEVICES OR SYSTEMS OR OTHER CRITICAL APPLICATIONS. INCLUSION OF TI PRODUCTS IN SUCH APPLICATIONS IS UNDERSTOOD TO BE FULLY AT THE CUSTOMER'S RISK.

In order to minimize risks associated with the customer's applications, adequate design and operating safeguards must be provided by the customer to minimize inherent or procedural hazards.

TI assumes no liability for applications assistance or customer product design. TI does not warrant or represent that any license, either express or implied, is granted under any patent right, copyright, mask work right, or other intellectual property right of TI covering or relating to any combination, machine, or process in which such semiconductor products or services might be or are used. TI's publication of information regarding any third party's products or services does not constitute TI's approval, warranty or endorsement thereof.