

## CMOS Dual 2-Wide 2-Input AND-OR-INVERT Gate

High-Voltage Types (20-Volt Rating)

■ CD4085 contains a pair of AND-OR-INVERT gates, each consisting of two 2-input AND gates driving a 3-input NOR gate. Individual inhibit controls are provided for both A-O-I gates.

The CD4085B types are supplied in 14-lead dual-in-line ceramic packages (D and F suffixes), 14-lead dual-in-line plastic packages (E suffix), and in chip form (H suffix).

### Features:

- Medium-speed operation —  $t_{PHL} = 90$  ns;  $t_{PLH} = 125$  ns (typ.) at 10 V
- Individual inhibit controls
- Standardized symmetrical output characteristics
- 100% tested for quiescent current at 20 V
- Maximum input current of  $1 \mu\text{A}$  at 18 V over full package-temperature range; 100 nA at 18 V and 25°C
- Noise margin (over full package-temperature range):
  - 1 V at  $V_{DD} = 5$  V
  - 2 V at  $V_{DD} = 10$  V
  - 2.5 V at  $V_{DD} = 15$  V
- 5-V, 10-V, and 15-V parametric ratings
- Meets all requirements of JEDEC Tentative Standard No. 13B, "Standard Specifications for Description of 'B' Series CMOS Devices"

### MAXIMUM RATINGS, Absolute-Maximum Values:

DC SUPPLY-VOLTAGE RANGE, ( $V_{DD}$ )	Voltages referenced to $V_{SS}$ Terminal)		-0.5V to +20V
INPUT VOLTAGE RANGE, ALL INPUTS			-0.5V to $V_{DD} + 0.5$ V
DC INPUT CURRENT, ANY ONE INPUT			$\pm 10$ mA
POWER DISSIPATION PER PACKAGE ( $P_D$ ):			
For $T_A = -55^\circ\text{C}$ to $+100^\circ\text{C}$			500 mW
For $T_A = +100^\circ\text{C}$ to $+125^\circ\text{C}$			Derate Linearity at 12 mW/°C to 200 mW
DEVICE DISSIPATION PER OUTPUT TRANSISTOR			
FOR $T_A = \text{FULL PACKAGE-TEMPERATURE RANGE (All Package Types)}$			100 mW
OPERATING-TEMPERATURE RANGE ( $T_A$ )			$-55^\circ\text{C}$ to $+125^\circ\text{C}$
STORAGE TEMPERATURE RANGE ( $T_{stg}$ )			$-65^\circ\text{C}$ to $+150^\circ\text{C}$
LEAD TEMPERATURE (DURING SOLDERING):			
At distance $1/16 \pm 1/32$ inch ( $1.59 \pm 0.79$ mm) from case for 10s max			$+265^\circ\text{C}$

### RECOMMENDED OPERATING CONDITIONS

For maximum reliability, nominal operating conditions should be selected so that operation is always within the following ranges:

CHARACTERISTIC	LIMITS		UNITS
	Min.	Max.	
Supply-Voltage Range (For $T_A = \text{Full Package-Temperature Range}$ )	3	18	V

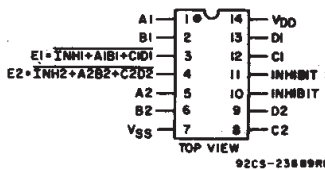

Terminal Assignment

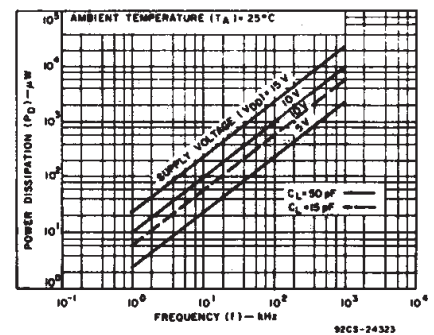
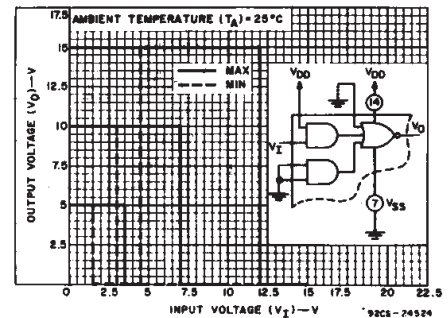
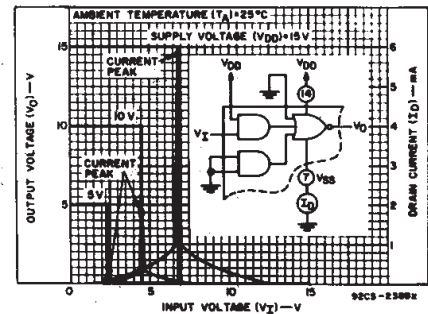
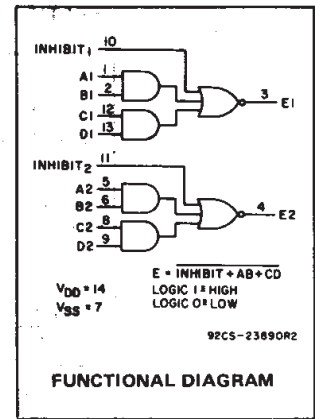

3  
COMMERCIAL CMOS  
HIGH VOLTAGE ICs

# CD4085B Types

## STATIC ELECTRICAL CHARACTERISTICS

CHARACTERISTIC	CONDITIONS			LIMITS AT INDICATED TEMPERATURES (°C)							UNITS
	V <sub>O</sub> (V)	V <sub>IN</sub> (V)	V <sub>DD</sub> (V)	-55	-40	+85	+125	+25			
								Min.	Typ.	Max.	
Quiescent Device Current I <sub>DD</sub> Max.	-	0,5	5	1	1	30	30	-	0.02	1	μA
	-	0,10	10	2	2	60	60	-	0.02	2	
	-	0,15	15	4	4	120	120	-	0.02	4	
	-	0,20	20	20	20	600	600	-	0.04	20	
Output Low (Sink) Current, I <sub>OL</sub> Min.	0.4	0,5	5	0.64	0.61	0.42	0.36	0.51	1	-	mA
	0.5	0,10	10	1.6	1.5	1.1	0.9	1.3	2.6	-	
	1.5	0,15	15	4.2	4	2.8	2.4	3.4	6.8	-	
	4.6	0,5	5	-0.64	-0.61	-0.42	-0.36	-0.51	-1	-	
Output High (Source) Current, I <sub>OH</sub> Min.	2.5	0,5	5	-2	-1.8	-1.3	-1.15	-1.6	-3.2	-	mA
	9.5	0,10	10	-1.6	-1.5	-1.1	-0.9	-1.3	-2.6	-	
	13.5	0,15	15	-4.2	-4	-2.8	-2.4	-3.4	-6.8	-	
	4.6	0,5	5	-0.64	-0.61	-0.42	-0.36	-0.51	-1	-	
Output Voltage: Low-Level, V <sub>OL</sub> Max.	-	0,5	5	0.05				-	0	0.05	V
	-	0,10	10	0.05				-	0	0.05	
	-	0,15	15	0.05				-	0	0.05	
Output Voltage: High-Level, V <sub>OH</sub> Min.	-	0,5	5	4.95				4.95	5	-	V
	-	0,10	10	9.95				9.95	10	-	
	-	0,15	15	14.95				14.95	15	-	
Input Low Voltage, V <sub>IL</sub> Max.	0.5, 4.5	-	5	1.5				-	-	1.5	V
	1.9	-	10	3				-	-	3	
	1.5, 13.5	-	15	4				-	-	4	
Input High Voltage, V <sub>IH</sub> Min.	0.5, 4.5	-	5	3.5				3.5	-	-	V
	1.9	-	10	7				7	-	-	
	1.5, 13.5	-	15	11				11	-	-	
Input Current, I <sub>IN</sub> Max.	-	0,18	18	±0.1	±0.1	±1	±1	-	±10 <sup>-5</sup>	±0.1	μA

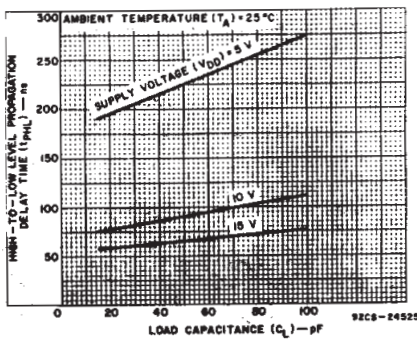

Fig. 4 - Typical data high-to-low level propagation delay time vs. load capacitance.

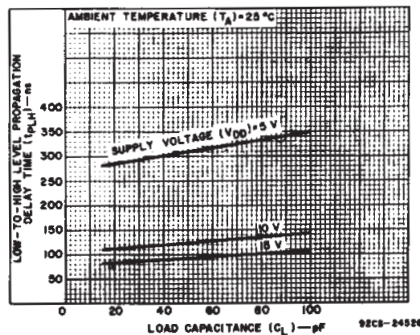

Fig. 5 - Typical data low-to-high level propagation delay time vs. load capacitance.

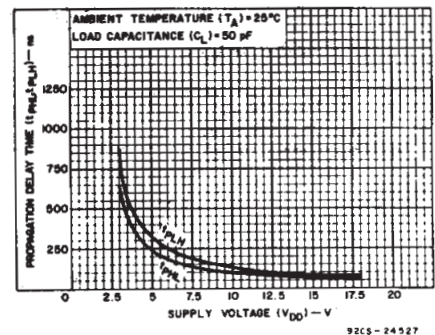

Fig. 6 - Typical data propagation delay time vs. supply voltage.

# CD4085B Types

DYNAMIC ELECTRICAL CHARACTERISTICS at  $T_A = 25^\circ\text{C}$ ; Input  $t_r, t_f = 20 \text{ ns}$ ,  $C_L = 50 \text{ pF}$ ,  $R_L = 200 \text{ k}\Omega$

CHARACTERISTIC	CONDITIONS	LIMITS		UNITS
		$V_{DD}$ V	Typ.	
Propagation Delay Time (Data): High-to-Low Level, $t_{PHL}$	5	225	450	ns
	10	90	180	
	15	65	130	
Low-to-High Level, $t_{PLH}$	5	310	620	ns
	10	125	250	
	15	90	180	
Propagation Delay Time (Inhibit): High-to-Low Level, $t_{PHL}$	5	150	300	ns
	10	60	120	
	15	40	80	
Low-to-High Level, $t_{PLH}$	5	250	500	ns
	10	100	200	
	15	70	140	
Transition Time, $t_{THL}, t_{TLH}$	5	100	200	ns
	10	50	100	
	15	40	80	
Input Capacitance, $C_{IN}$	Any Input	5	7.5	pF

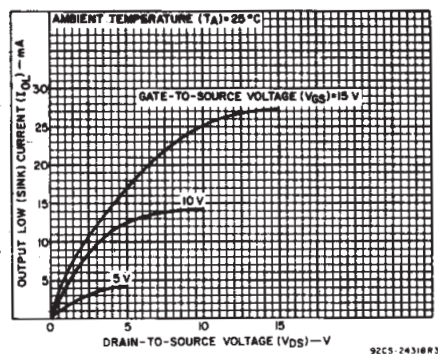

Fig. 7 - Typical output low (sink) current characteristics.

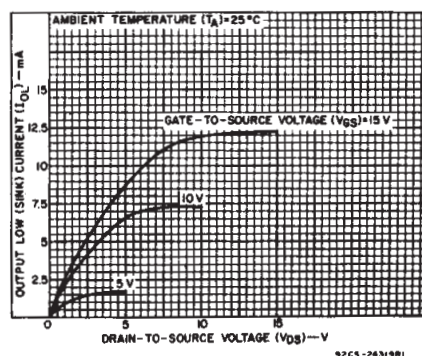

Fig. 8 - Minimum output low (sink) current characteristics.

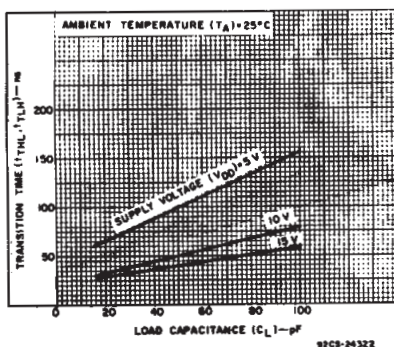

Fig. 9 - Typical transition time vs. load capacitance.

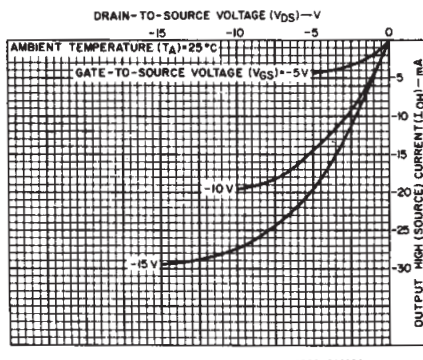

Fig. 10 - Typical output high (source) current characteristics.

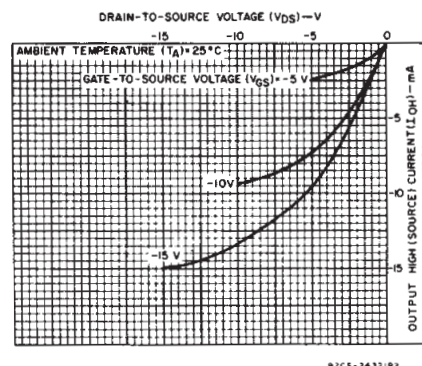

Fig. 11 - Minimum output high (source) current characteristics.

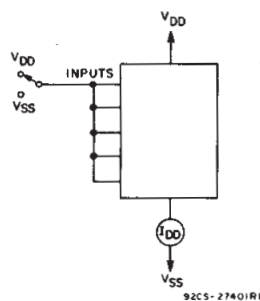

Fig. 12 - Quiescent device current test circuit.

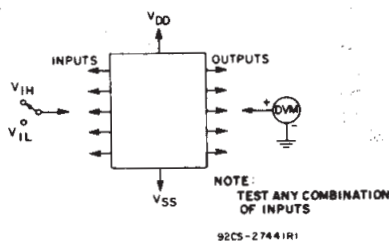

Fig. 13 - Input voltage test circuit.

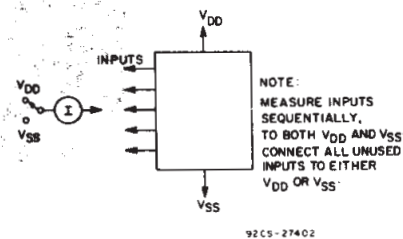

Fig. 14 - Input current test circuit.

3  
COMMERCIAL CMOS  
HIGH VOLTAGE ICs

# CD4085B Types

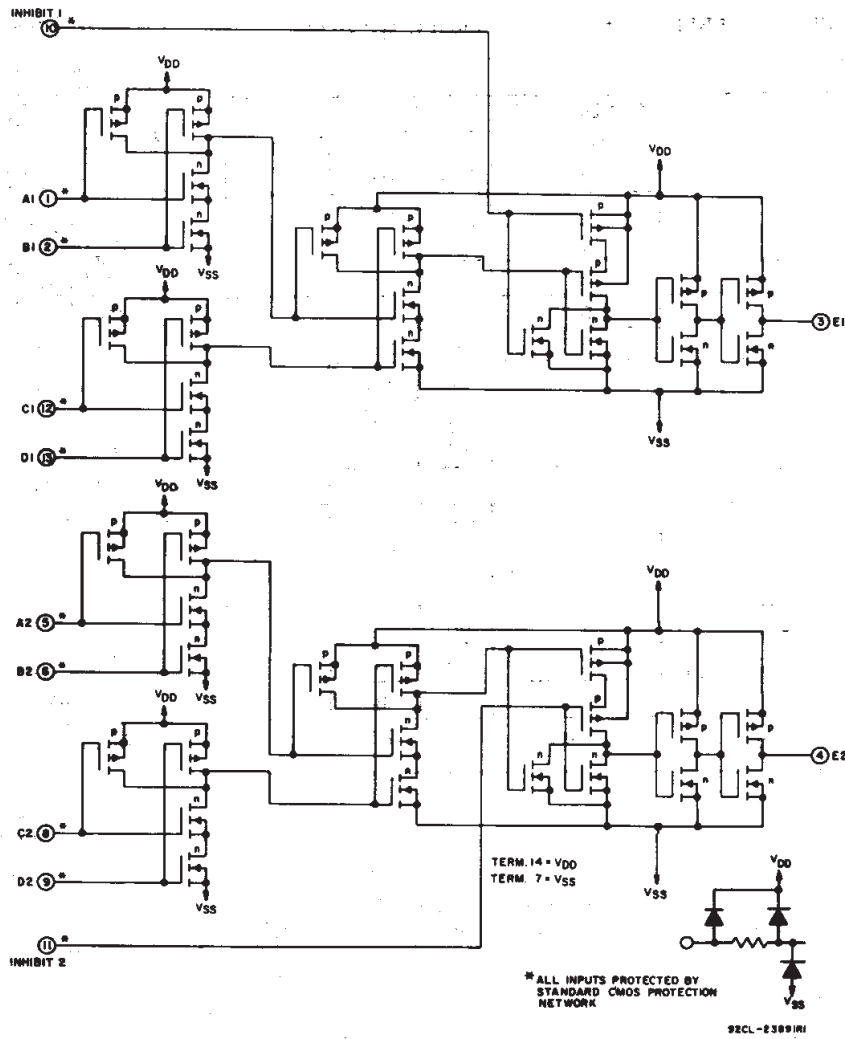
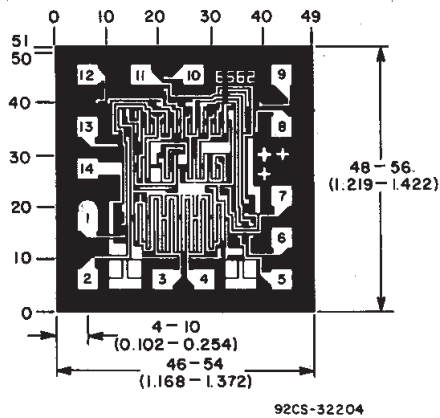

Fig. 15 - CD4085 schematic diagram.



Dimensions in parentheses are in millimeters and are derived from the basic inch dimensions as indicated. Grid graduations are in mils ( $10^{-3}$  inch).

Dimensions and Pad Layout for CD4085BH.



## **IMPORTANT NOTICE**

Texas Instruments and its subsidiaries (TI) reserve the right to make changes to their products or to discontinue any product or service without notice, and advise customers to obtain the latest version of relevant information to verify, before placing orders, that information being relied on is current and complete. All products are sold subject to the terms and conditions of sale supplied at the time of order acknowledgement, including those pertaining to warranty, patent infringement, and limitation of liability.

TI warrants performance of its semiconductor products to the specifications applicable at the time of sale in accordance with TI's standard warranty. Testing and other quality control techniques are utilized to the extent TI deems necessary to support this warranty. Specific testing of all parameters of each device is not necessarily performed, except those mandated by government requirements.

**CERTAIN APPLICATIONS USING SEMICONDUCTOR PRODUCTS MAY INVOLVE POTENTIAL RISKS OF DEATH, PERSONAL INJURY, OR SEVERE PROPERTY OR ENVIRONMENTAL DAMAGE ("CRITICAL APPLICATIONS"). TI SEMICONDUCTOR PRODUCTS ARE NOT DESIGNED, AUTHORIZED, OR WARRANTED TO BE SUITABLE FOR USE IN LIFE-SUPPORT DEVICES OR SYSTEMS OR OTHER CRITICAL APPLICATIONS. INCLUSION OF TI PRODUCTS IN SUCH APPLICATIONS IS UNDERSTOOD TO BE FULLY AT THE CUSTOMER'S RISK.**

In order to minimize risks associated with the customer's applications, adequate design and operating safeguards must be provided by the customer to minimize inherent or procedural hazards.

TI assumes no liability for applications assistance or customer product design. TI does not warrant or represent that any license, either express or implied, is granted under any patent right, copyright, mask work right, or other intellectual property right of TI covering or relating to any combination, machine, or process in which such semiconductor products or services might be or are used. TI's publication of information regarding any third party's products or services does not constitute TI's approval, warranty or endorsement thereof.