

SN74LVC244A OCTAL BUFFER/DRIVER WITH 3-STATE OUTPUTS

SCAS414L – NOVEMBER 1992 – REVISED APRIL 1999

- **EPIC™ (Enhanced-Performance Implanted CMOS) Submicron Process**
- **Typical V_{OLP} (Output Ground Bounce) <0.8 V at $V_{CC} = 3.3$ V, $T_A = 25^\circ\text{C}$**
- **Typical V_{OHV} (Output V_{OH} Undershoot) >2 V at $V_{CC} = 3.3$ V, $T_A = 25^\circ\text{C}$**
- **Power Off Disables Outputs, Permitting Live Insertion**
- **Supports Mixed-Mode Signal Operation on All Ports (5-V Input/Output Voltage With 3.3-V V_{CC})**
- **ESD Protection Exceeds 2000 V Per MIL-STD-883, Method 3015; Exceeds 200 V Using Machine Model (C = 200 pF, R = 0)**
- **Latch-Up Performance Exceeds 250 mA Per JESD 17**
- **Package Options Include Shrink Small-Outline (DB), Plastic Small-Outline (DW), and Thin Shrink Small-Outline (PW) Packages**

DB, DW, OR PW PACKAGE
(TOP VIEW)

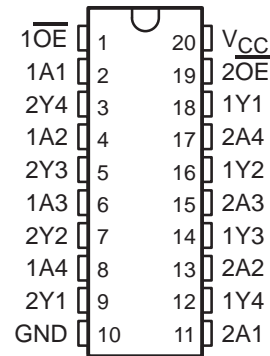

description

This octal buffer/line driver is operational at 1.5-V to 3.6-V V_{CC} , but designed specifically for 1.65-V to 3.6-V V_{CC} operation.

The SN74LVC244A is organized as two 4-bit line drivers with separate output-enable (\overline{OE}) inputs. When \overline{OE} is low, the device passes data from the A inputs to the Y outputs. When \overline{OE} is high, the outputs are in the high-impedance state.

Inputs can be driven from either 3.3-V or 5-V devices. This feature allows the use of these devices as translators in a mixed 3.3-V/5-V system environment.

To ensure the high-impedance state during power up or power down, \overline{OE} should be tied to V_{CC} through a pullup resistor; the minimum value of the resistor is determined by the current-sinking capability of the driver.

The SN74LVC244A is characterized for operation from -40°C to 85°C .

FUNCTION TABLE
(each buffer)

INPUTS		OUTPUT
\overline{OE}	A	Y
L	H	H
L	L	L
H	X	Z



Please be aware that an important notice concerning availability, standard warranty, and use in critical applications of Texas Instruments semiconductor products and disclaimers thereto appears at the end of this data sheet.

EPIC is a trademark of Texas Instruments Incorporated.

PRODUCTION DATA information is current as of publication date. Products conform to specifications per the terms of Texas Instruments standard warranty. Production processing does not necessarily include testing of all parameters.

 **TEXAS
INSTRUMENTS**

POST OFFICE BOX 655303 • DALLAS, TEXAS 75265

Copyright © 1999, Texas Instruments Incorporated

SN74LVC244A
OCTAL BUFFER/DRIVER
WITH 3-STATE OUTPUTS

SCAS414L – NOVEMBER 1992 – REVISED APRIL 1999

logic symbol†

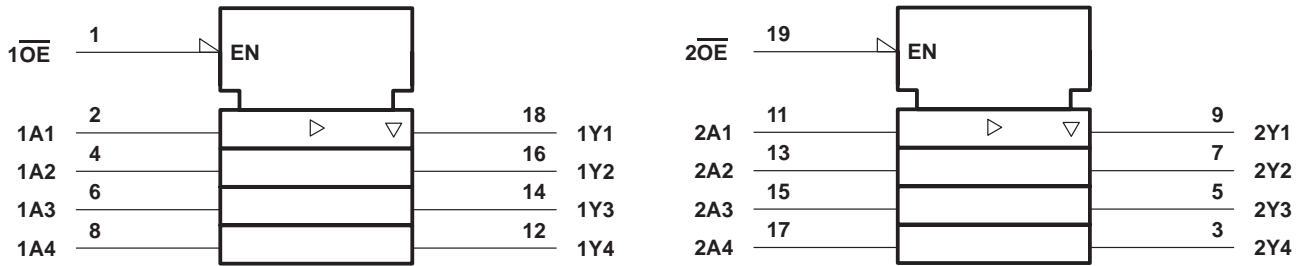

† This symbol is in accordance with ANSI/IEEE Std 91-1984 and IEC Publication 617-12.

logic diagram (positive logic)

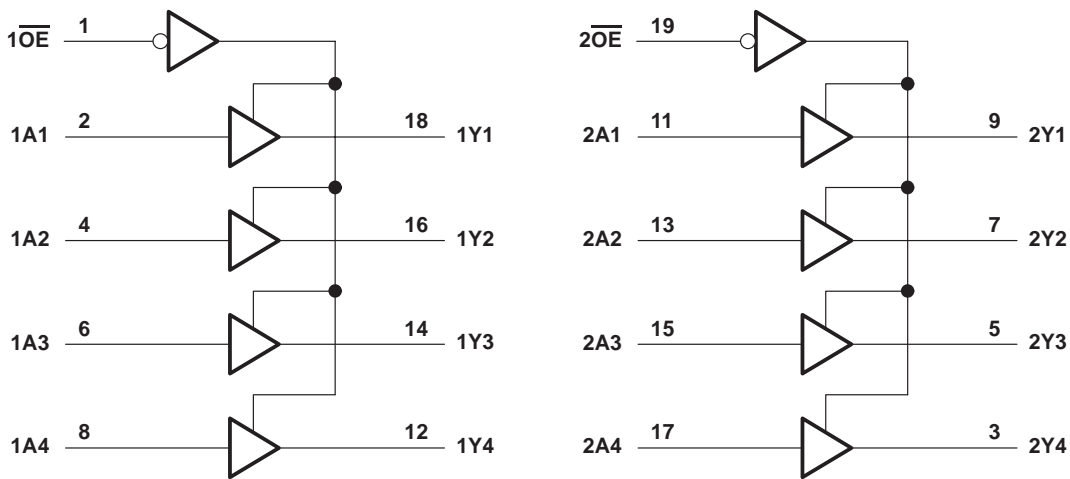

absolute maximum ratings over operating free-air temperature range (unless otherwise noted)‡

Supply voltage range, V_{CC}	–0.5 V to 6.5 V
Input voltage range, V_I (see Note 1)	–0.5 V to 6.5 V
Voltage range applied to any output in the high-impedance or power-off state, V_O (see Note 1)	–0.5 V to 6.5 V
Voltage range applied to any output in the high or low state, V_O (see Notes 1 and 2)	–0.5 V to $V_{CC} + 0.5$ V
Input clamp current, I_{IK} ($V_I < 0$)	–50 mA
Output clamp current, I_{OK} ($V_O < 0$)	–50 mA
Continuous output current, I_O	± 50 mA
Continuous current through V_{CC} or GND	± 100 mA
Package thermal impedance, θ_{JA} (see Note 3):	
DB package	115°C/W
DW package	97°C/W
PW package	128°C/W
Storage temperature range, T_{stg}	–65°C to 150°C

‡ Stresses beyond those listed under “absolute maximum ratings” may cause permanent damage to the device. These are stress ratings only, and functional operation of the device at these or any other conditions beyond those indicated under “recommended operating conditions” is not implied. Exposure to absolute-maximum-rated conditions for extended periods may affect device reliability.

- NOTES: 1. The input negative-voltage and output voltage ratings may be exceeded if the input and output current ratings are observed.
 2. The value of V_{CC} is provided in the recommended operating conditions table.
 3. The package thermal impedance is calculated in accordance with JESD 51.

SN74LVC244A
OCTAL BUFFER/DRIVER
WITH 3-STATE OUTPUTS

SCAS414L – NOVEMBER 1992 – REVISED APRIL 1999

recommended operating conditions (see Note 4)

		MIN	MAX	UNIT	
V _{CC}	Supply voltage	Operating	1.65	3.6	V
		Data retention only	1.5		
V _{IH}	High-level input voltage	V _{CC} = 1.65 V to 1.95 V	0.65 × V _{CC}		V
		V _{CC} = 2.3 V to 2.7 V	1.7		
		V _{CC} = 2.7 V to 3.6 V	2		
V _{IL}	Low-level input voltage	V _{CC} = 1.65 V to 1.95 V	0.35 × V _{CC}		V
		V _{CC} = 2.3 V to 2.7 V	0.7		
		V _{CC} = 2.7 V to 3.6 V	0.8		
V _I	Input voltage	0	5.5	V	
V _O	Output voltage	High or low state	0	V _{CC}	V
		3 state	0	5.5	
I _{OH}	High-level output current	V _{CC} = 1.65 V	–4		mA
		V _{CC} = 2.3 V	–8		
		V _{CC} = 2.7 V	–12		
		V _{CC} = 3 V	–24		
I _{OL}	Low-level output current	V _{CC} = 1.65 V	4		mA
		V _{CC} = 2.3 V	8		
		V _{CC} = 2.7 V	12		
		V _{CC} = 3 V	24		
T _A	Operating free-air temperature	–40	85	°C	

NOTE 4: All unused inputs of the device must be held at V_{CC} or GND to ensure proper device operation. Refer to the TI application report, *Implications of Slow or Floating CMOS Inputs*, literature number SCBA004.

SN74LVC244A

OCTAL BUFFER/DRIVER

WITH 3-STATE OUTPUTS

SCAS414L – NOVEMBER 1992 – REVISED APRIL 1999

electrical characteristics over recommended operating free-air temperature range (unless otherwise noted)

PARAMETER	TEST CONDITIONS	V _{CC}	MIN	TYP†	MAX	UNIT
V _{OH}	I _{OH} = -100 μA	1.65 V to 3.6 V	V _{CC} -0.2			V
	I _{OH} = -4 mA	1.65 V	1.2			
	I _{OH} = -8 mA	2.3 V	1.7			
	I _{OH} = -12 mA	2.7 V	2.2			
	I _{OH} = -24 mA	3 V	2.4			
V _{OL}	I _{OL} = 100 μA	1.65 V to 3.6 V			0.2	V
	I _{OL} = 4 mA	1.65 V			0.45	
	I _{OL} = 8 mA	2.3 V			0.7	
	I _{OL} = 12 mA	2.7 V			0.4	
	I _{OL} = 24 mA	3 V			0.55	
I _I	V _I = 0 to 5.5 V	3.6 V			±5	μA
I _{off}	V _I or V _O = 5.5 V	0			±10	μA
I _{OZ}	V _O = 0 to 5.5 V	3.6 V			±10	μA
I _{CC}	V _I = V _{CC} or GND	3.6 V	I _O = 0		10	μA
	3.6 V ≤ V _I ≤ 5.5 V‡				10	
ΔI _{CC}	One input at V _{CC} - 0.6 V, Other inputs at V _{CC} or GND	2.7 V to 3.6 V			500	μA
C _i	V _I = V _{CC} or GND	3.3 V		4		pF
C _o	V _O = V _{CC} or GND	3.3 V		5.5		pF

† All typical values are at V_{CC} = 3.3 V, T_A = 25°C.

‡ This applies in the disabled state only.

switching characteristics over recommended operating free-air temperature range (unless otherwise noted) (see Figures 1 through 4)

PARAMETER	FROM (INPUT)	TO (OUTPUT)	V _{CC} = 1.5 V	V _{CC} = 1.8 V	V _{CC} = 2.5 V ± 0.2 V		V _{CC} = 2.7 V		V _{CC} = 3.3 V ± 0.3 V		UNIT
			TYP	TYP	MIN	MAX	MIN	MAX	MIN	MAX	
t _{pd}	A	Y	5.75	12	1	7.9	6.9	1.5	5.9	ns	
t _{en}	\overline{OE}	Y	6.59	13.1	1	9.6	8.6	1.5	7.6	ns	
t _{dis}	\overline{OE}	Y	5.7	14.6	1	7.8	6.8	1.5	6.5	ns	

operating characteristics, T_A = 25°C

PARAMETER		TEST CONDITIONS	V _{CC} = 1.8 V	V _{CC} = 2.5 V	V _{CC} = 3.3 V	UNIT
			TYP	TYP	TYP	
C _{pd}	Power dissipation capacitance per buffer/driver	Outputs enabled	43	43	44	pF
		Outputs disabled	1	1	2	



PARAMETER MEASUREMENT INFORMATION
 $V_{CC} = 1.5\text{ V}$

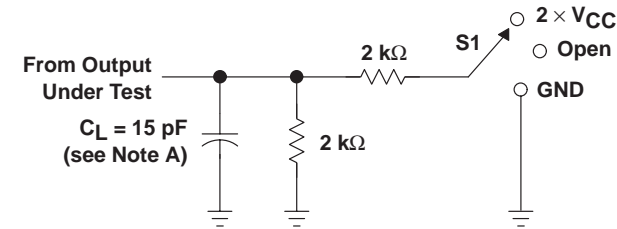

LOAD CIRCUIT

TEST	S1
t_{pd}	Open
t_{PLZ}/t_{PZL}	$2 \times V_{CC}$
t_{PHZ}/t_{PZH}	GND



VOLTAGE WAVEFORMS
SETUP AND HOLD TIMES

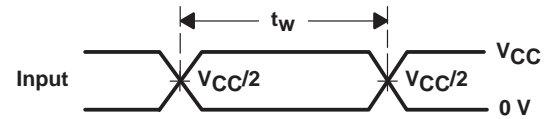

VOLTAGE WAVEFORMS
PULSE DURATION

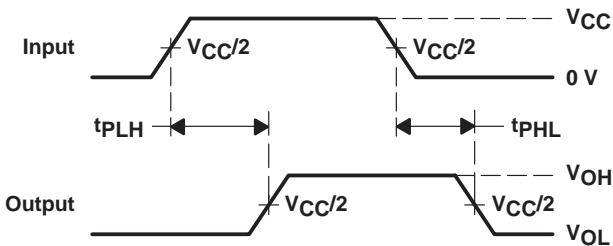

VOLTAGE WAVEFORMS
PROPAGATION DELAY TIMES

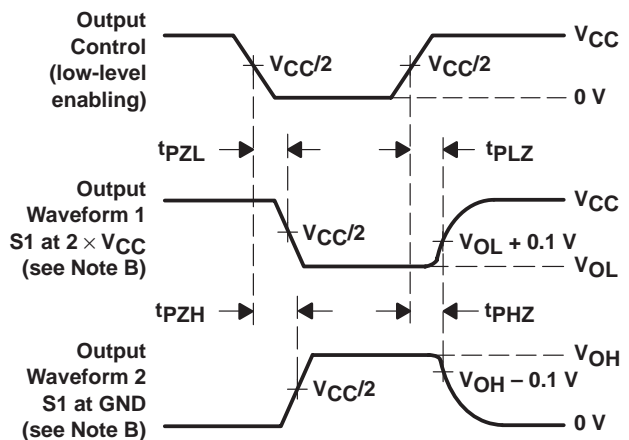

VOLTAGE WAVEFORMS
ENABLE AND DISABLE TIMES

- NOTES: A. C_L includes probe and jig capacitance.
B. Waveform 1 is for an output with internal conditions such that the output is low except when disabled by the output control. Waveform 2 is for an output with internal conditions such that the output is high except when disabled by the output control.
C. All input pulses are supplied by generators having the following characteristics: $PRR \leq 10\text{ MHz}$, $Z_O = 50\ \Omega$, $t_r \leq 2\text{ ns}$, $t_f \leq 2\text{ ns}$.
D. The outputs are measured one at a time with one transition per measurement.
E. t_{PLZ} and t_{PHZ} are the same as t_{dis} .
F. t_{PZL} and t_{PZH} are the same as t_{en} .
G. t_{PLH} and t_{PHL} are the same as t_{pd} .

Figure 1. Load Circuit and Voltage Waveforms

SN74LVC244A
OCTAL BUFFER/DRIVER
WITH 3-STATE OUTPUTS

SCAS414L – NOVEMBER 1992 – REVISED APRIL 1999

PARAMETER MEASUREMENT INFORMATION

$V_{CC} = 1.8\text{ V}$

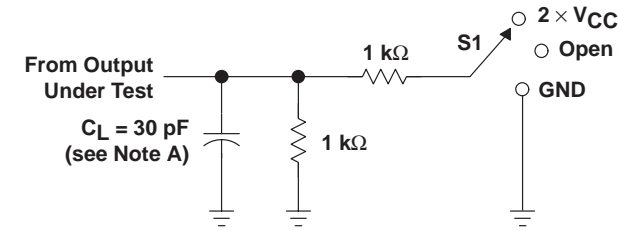

LOAD CIRCUIT

TEST	S1
t_{pd}	Open
t_{PLZ}/t_{PZL}	$2 \times V_{CC}$
t_{PHZ}/t_{PZH}	GND

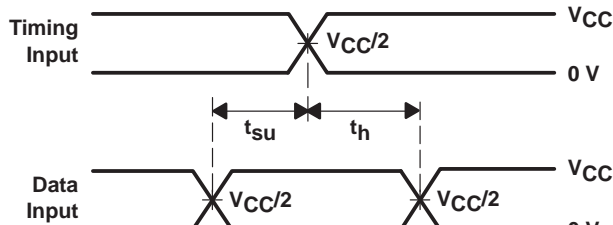

**VOLTAGE WAVEFORMS
 SETUP AND HOLD TIMES**

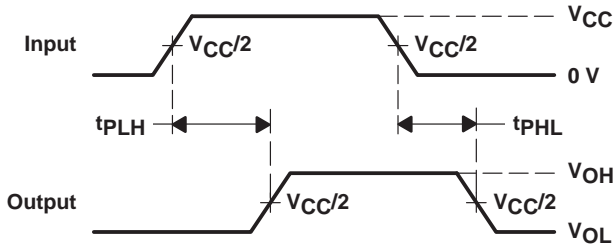

**VOLTAGE WAVEFORMS
 PROPAGATION DELAY TIMES**

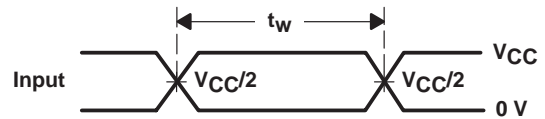

**VOLTAGE WAVEFORMS
 PULSE DURATION**

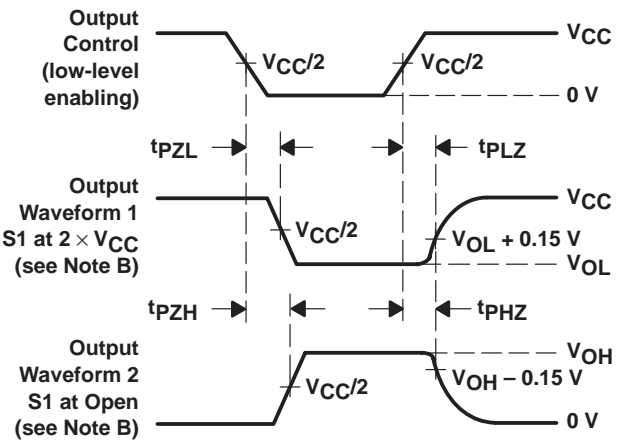

**VOLTAGE WAVEFORMS
 ENABLE AND DISABLE TIMES**

- NOTES:
- A. C_L includes probe and jig capacitance.
 - B. Waveform 1 is for an output with internal conditions such that the output is low except when disabled by the output control. Waveform 2 is for an output with internal conditions such that the output is high except when disabled by the output control.
 - C. All input pulses are supplied by generators having the following characteristics: $PRR \leq 10\text{ MHz}$, $Z_O = 50\ \Omega$, $t_r \leq 2\text{ ns}$, $t_f \leq 2\text{ ns}$.
 - D. The outputs are measured one at a time with one transition per measurement.
 - E. t_{PLZ} and t_{PHZ} are the same as t_{dis} .
 - F. t_{PZL} and t_{PZH} are the same as t_{en} .
 - G. t_{PLH} and t_{PHL} are the same as t_{pd} .

Figure 2. Load Circuit and Voltage Waveforms

PARAMETER MEASUREMENT INFORMATION

$V_{CC} = 2.5\text{ V} \pm 0.2\text{ V}$

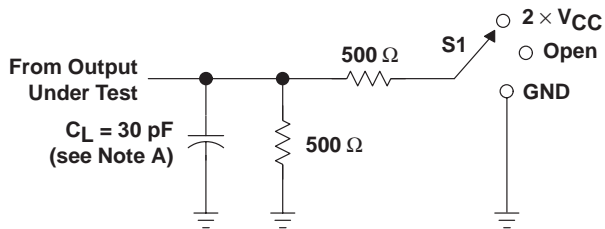

LOAD CIRCUIT

TEST	S1
t_{pd}	Open
t_{PLZ}/t_{PZL}	2 $\times V_{CC}$
t_{PHZ}/t_{PZH}	GND

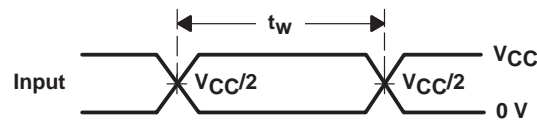

VOLTAGE WAVEFORMS
PULSE DURATION

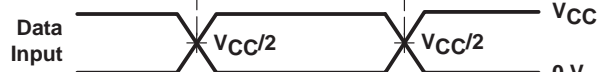

VOLTAGE WAVEFORMS
SETUP AND HOLD TIMES

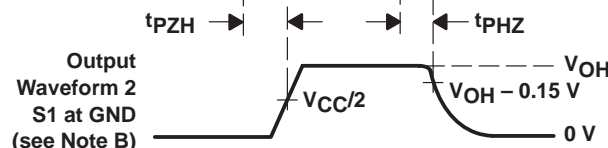
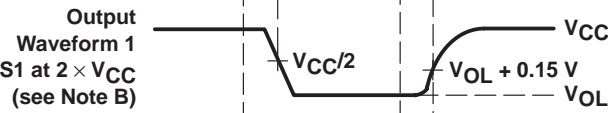

VOLTAGE WAVEFORMS
ENABLE AND DISABLE TIMES

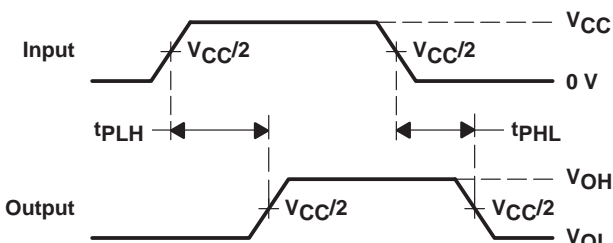

VOLTAGE WAVEFORMS
PROPAGATION DELAY TIMES

- NOTES: A. C_L includes probe and jig capacitance.
 B. Waveform 1 is for an output with internal conditions such that the output is low except when disabled by the output control. Waveform 2 is for an output with internal conditions such that the output is high except when disabled by the output control.
 C. All input pulses are supplied by generators having the following characteristics: PRR $\leq 10\text{ MHz}$, $Z_O = 50\ \Omega$, $t_r \leq 2\text{ ns}$, $t_f \leq 2\text{ ns}$.
 D. The outputs are measured one at a time with one transition per measurement.
 E. t_{PLZ} and t_{PHZ} are the same as t_{dis} .
 F. t_{PZL} and t_{PZH} are the same as t_{en} .
 G. t_{PLH} and t_{PHL} are the same as t_{pd} .

Figure 3. Load Circuit and Voltage Waveforms

SN74LVC244A
OCTAL BUFFER/DRIVER
WITH 3-STATE OUTPUTS

SCAS414L – NOVEMBER 1992 – REVISED APRIL 1999

PARAMETER MEASUREMENT INFORMATION

$V_{CC} = 2.7\text{ V AND } 3.3\text{ V} \pm 0.3\text{ V}$

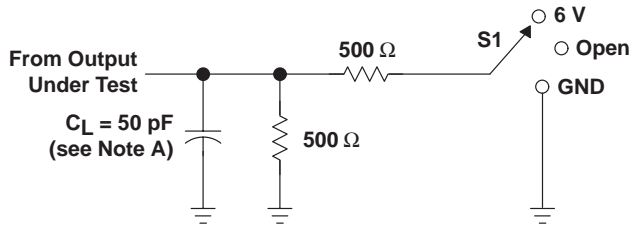

LOAD CIRCUIT

TEST	S1
t_{pd}	Open
t_{PLZ}/t_{PZL}	6 V
t_{PHZ}/t_{PHZ}	GND

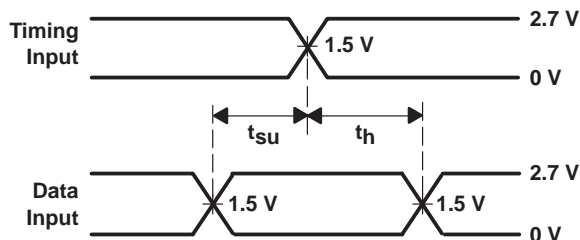

**VOLTAGE WAVEFORMS
 SETUP AND HOLD TIMES**

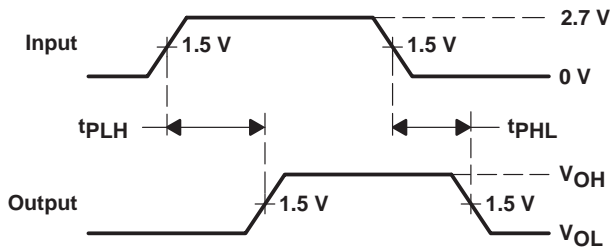

**VOLTAGE WAVEFORMS
 PROPAGATION DELAY TIMES**

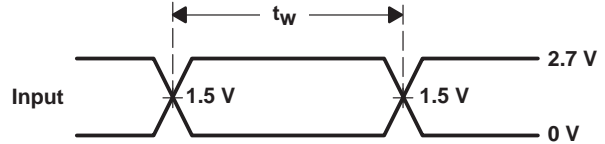

**VOLTAGE WAVEFORMS
 PULSE DURATION**

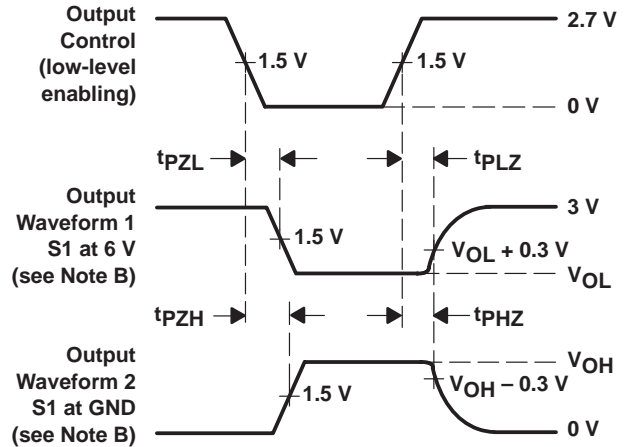

**VOLTAGE WAVEFORMS
 ENABLE AND DISABLE TIMES**

- NOTES: A. C_L includes probe and jig capacitance.
 B. Waveform 1 is for an output with internal conditions such that the output is low except when disabled by the output control. Waveform 2 is for an output with internal conditions such that the output is high except when disabled by the output control.
 C. All input pulses are supplied by generators having the following characteristics: $PRR \leq 10\text{ MHz}$, $Z_O = 50\ \Omega$, $t_r \leq 2.5\text{ ns}$, $t_f \leq 2.5\text{ ns}$.
 D. The outputs are measured one at a time with one transition per measurement.
 E. t_{PLZ} and t_{PHZ} are the same as t_{dis} .
 F. t_{PZL} and t_{PZH} are the same as t_{en} .
 G. t_{PLH} and t_{PHL} are the same as t_{pd} .

Figure 4. Load Circuit and Voltage Waveforms

IMPORTANT NOTICE

Texas Instruments and its subsidiaries (TI) reserve the right to make changes to their products or to discontinue any product or service without notice, and advise customers to obtain the latest version of relevant information to verify, before placing orders, that information being relied on is current and complete. All products are sold subject to the terms and conditions of sale supplied at the time of order acknowledgement, including those pertaining to warranty, patent infringement, and limitation of liability.

TI warrants performance of its semiconductor products to the specifications applicable at the time of sale in accordance with TI's standard warranty. Testing and other quality control techniques are utilized to the extent TI deems necessary to support this warranty. Specific testing of all parameters of each device is not necessarily performed, except those mandated by government requirements.

CERTAIN APPLICATIONS USING SEMICONDUCTOR PRODUCTS MAY INVOLVE POTENTIAL RISKS OF DEATH, PERSONAL INJURY, OR SEVERE PROPERTY OR ENVIRONMENTAL DAMAGE ("CRITICAL APPLICATIONS"). TI SEMICONDUCTOR PRODUCTS ARE NOT DESIGNED, AUTHORIZED, OR WARRANTED TO BE SUITABLE FOR USE IN LIFE-SUPPORT DEVICES OR SYSTEMS OR OTHER CRITICAL APPLICATIONS. INCLUSION OF TI PRODUCTS IN SUCH APPLICATIONS IS UNDERSTOOD TO BE FULLY AT THE CUSTOMER'S RISK.

In order to minimize risks associated with the customer's applications, adequate design and operating safeguards must be provided by the customer to minimize inherent or procedural hazards.

TI assumes no liability for applications assistance or customer product design. TI does not warrant or represent that any license, either express or implied, is granted under any patent right, copyright, mask work right, or other intellectual property right of TI covering or relating to any combination, machine, or process in which such semiconductor products or services might be or are used. TI's publication of information regarding any third party's products or services does not constitute TI's approval, warranty or endorsement thereof.