

# TPA112 150-mW STEREO AUDIO POWER AMPLIFIER

SLOS212C – AUGUST 1998 – REVISED MARCH 2000

- 150-mW Stereo Output
- Wide Range of Supply Voltages
  - Fully Specified for 3.3 V and 5 V Operation
  - Operational From 2.5 V to 5.5 V
- Thermal and Short-Circuit Protection
- Surface Mount Packaging
  - PowerPAD™ MSOP
  - SOIC
- Standard Operational Amplifier Pinout

D OR DGN PACKAGE  
(TOP VIEW)

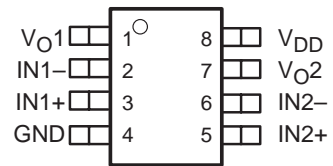

## description

The TPA112 is a stereo audio power amplifier packaged in an 8-pin PowerPAD™ MSOP package capable of delivering 150 mW of continuous RMS power per channel into 8-Ω loads. Amplifier gain is externally configured by means of two resistors per input channel and does not require external compensation for settings of 1 to 10.

THD+N when driving an 8-Ω load from 5 V is 0.1% at 1 kHz, and less than 2% across the audio band of 20 Hz to 20 kHz. For 32-Ω loads, the THD+N is reduced to less than 0.06% at 1 kHz, and is less than 1% across the audio band of 20 Hz to 20 kHz. For 10-kΩ loads, the THD+N performance is 0.01% at 1 kHz, and less than 0.02% across the audio band of 20 Hz to 20 kHz.

## functional block diagram

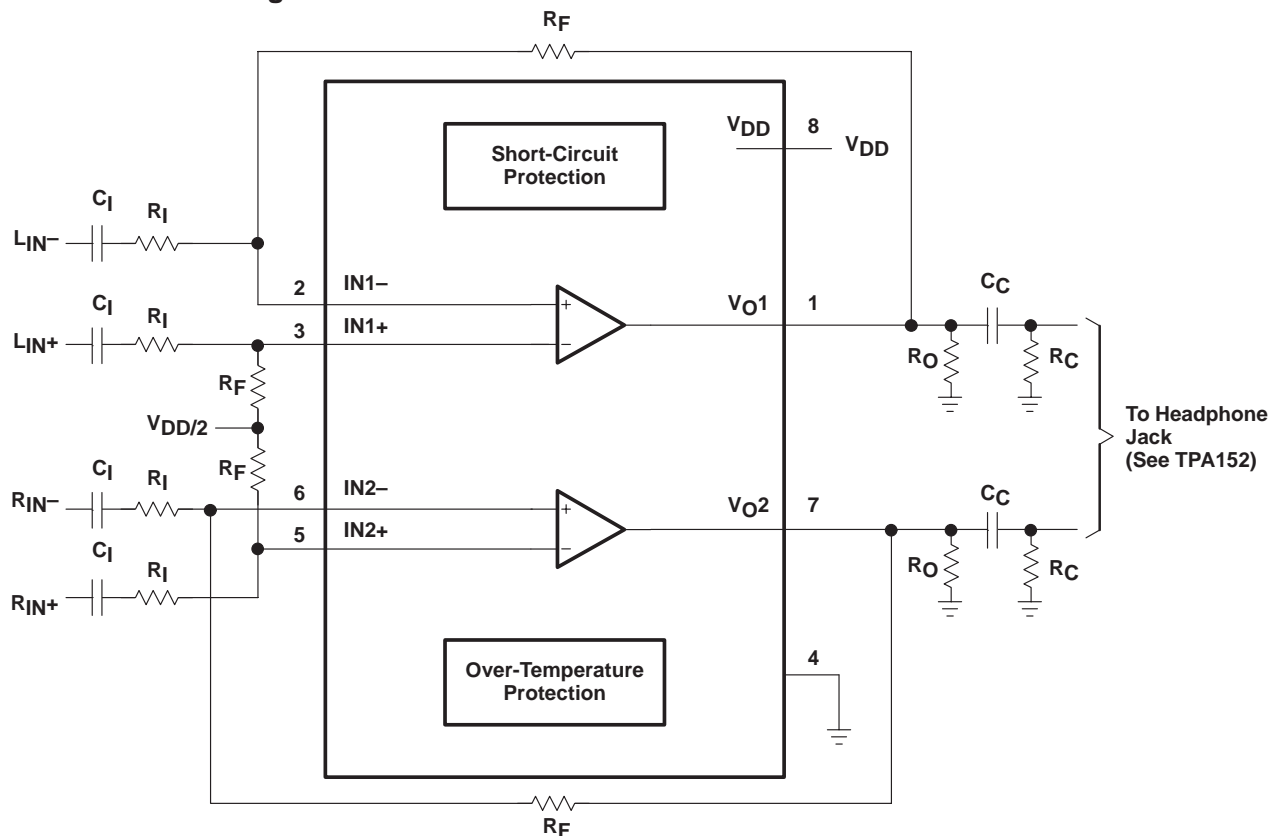

Please be aware that an important notice concerning availability, standard warranty, and use in critical applications of Texas Instruments semiconductor products and disclaimers thereto appears at the end of this data sheet.

PowerPAD is a trademark of Texas Instruments.

PRODUCTION DATA information is current as of publication date. Products conform to specifications per the terms of Texas Instruments standard warranty. Production processing does not necessarily include testing of all parameters.

**TEXAS  
INSTRUMENTS**

POST OFFICE BOX 655303 • DALLAS, TEXAS 75265

Copyright © 2000, Texas Instruments Incorporated

# TPA112

## 150-mW STEREO AUDIO POWER AMPLIFIER

SLOS212C – AUGUST 1998 – REVISED MARCH 2000

### AVAILABLE OPTIONS

T <sub>A</sub>	PACKAGED DEVICES		MSOP Symbolization
	SMALL OUTLINE† (D)	MSOP† (DGN)	
–40°C to 85°C	TPA112D	TPA112DGN	TI AAD

† The D and DGN package is available in left-ended tape and reel only (e.g., TPA112DR, TPA112DGNR).

### Terminal Functions

TERMINAL NAME	NO.	I/O	DESCRIPTION
GND	4	I	GND is the ground connection.
IN1–	2	I	IN1– is the inverting input for channel 1.
IN1+	3	I	IN1+ is the noninverting input for channel 1.
IN2–	6	I	IN2– is the inverting input for channel 2.
IN2+	5	I	IN2+ is the noninverting input for channel 2.
V <sub>DD</sub>	8	I	V <sub>DD</sub> is the supply voltage terminal.
V <sub>O1</sub>	1	O	V <sub>O1</sub> is the audio output for channel 1.
V <sub>O2</sub>	7	O	V <sub>O2</sub> is the audio output for channel 2.

### absolute maximum ratings over operating free-air temperature (unless otherwise noted)†

Supply voltage, V <sub>DD</sub>	6 V
Differential input voltage, V <sub>I</sub>	–0.3 V to V <sub>DD</sub> + 0.3 V
Input current, I <sub>I</sub>	±2.5 μA
Output current, I <sub>O</sub>	±250 mA
Continuous total power dissipation	internally limited
Operating junction temperature range, T <sub>J</sub>	–40°C to 150°C
Storage temperature range, T <sub>stg</sub>	–65°C to 150°C
Lead temperature 1,6 mm (1/16 inch) from case for 10 seconds	260°C

† Stresses beyond those listed under “absolute maximum ratings” may cause permanent damage to the device. These are stress ratings only, and functional operation of the device at these or any other conditions beyond those indicated under “recommended operating conditions” is not implied. Exposure to absolute-maximum-rated conditions for extended periods may affect device reliability.

### DISSIPATION RATING TABLE

PACKAGE	T <sub>A</sub> ≤ 25°C POWER RATING	DERATING FACTOR ABOVE T <sub>A</sub> = 25°C	T <sub>A</sub> = 70°C POWER RATING	T <sub>A</sub> = 85°C POWER RATING
D	725 mW	5.8 mW/°C	464 mW	377 mW
DGN	2.14 W‡	17.1 mW/°C	1.37 W	1.11 W

‡ Please see the Texas Instruments document, *PowerPAD Thermally Enhanced Package Application Report* (literature number SLMA002), for more information on the PowerPAD package. The thermal data was measured on a PCB layout based on the information in the section entitled *Texas Instruments Recommended Board for PowerPAD* on page 33 of the before mentioned document.

### recommended operating conditions

	MIN	MAX	UNIT
Supply voltage, V <sub>DD</sub>	2.5	5.5	V
Operating free-air temperature, T <sub>A</sub>	–40	85	°C



POST OFFICE BOX 655303 • DALLAS, TEXAS 75265

# TPA112

## 150-mW STEREO AUDIO POWER AMPLIFIER

SLOS212C – AUGUST 1998 – REVISED MARCH 2000

### dc electrical characteristics at $T_A = 25^\circ\text{C}$ , $V_{DD} = 3.3\text{ V}$

PARAMETER		TEST CONDITIONS	MIN	TYP	MAX	UNIT
$V_{IO}$	Input offset voltage				5	mV
PSRR	Power supply rejection ratio	$V_{DD} = 3.2\text{ V to } 3.4\text{ V}$		83		dB
$I_{DD}(q)$	Supply current			1.5	3	mA
$I_{DD}(SD)$	Supply current in SHUTDOWN mode			10	50	$\mu\text{A}$
$Z_I$	Input impedance			> 1		$\text{M}\Omega$

### ac operating characteristics, $V_{DD} = 3.3\text{ V}$ , $T_A = 25^\circ\text{C}$ , $R_L = 8\ \Omega$

PARAMETER		TEST CONDITIONS	MIN	TYP	MAX	UNIT
$P_O$	Output power (each channel)	$\text{THD} \leq 0.1\%$		70†		mW
THD+N	Total harmonic distortion + noise	$P_O = 70\text{ mW}$ , 20–20 kHz		2%		
B <sub>OM</sub>	Maximum output power BW	$G = 10$ , THD <5%		>20		kHz
	Phase margin	Open loop		58°		
$S_{VRR}$	Supply ripple rejection	$f = 1\text{ kHz}$		68		dB
	Channel/channel output separation	$f = 1\text{ kHz}$		86		dB
SNR	Signal-to-noise ratio	$P_O = 100\text{ mW}$		100		dB
$V_n$	Noise output voltage			9.5		$\mu\text{V}(\text{rms})$

† Measured at 1 kHz

### dc electrical characteristics at $T_A = 25^\circ\text{C}$ , $V_{DD} = 5\text{ V}$

PARAMETER		TEST CONDITIONS	MIN	TYP	MAX	UNIT
$V_{IO}$	Input offset voltage				5	mV
PSRR	Power supply rejection ratio	$V_{DD} = 4.9\text{ V to } 5.1\text{ V}$		76		dB
$I_{DD}(q)$	Supply current			1.5	3	mA
$I_{DD}(SD)$	Supply current in SHUTDOWN mode			60	100	$\mu\text{A}$
$Z_I$	Input impedance			> 1		$\text{M}\Omega$

### ac operating characteristics, $V_{DD} = 5\text{ V}$ , $T_A = 25^\circ\text{C}$ , $R_L = 8\ \Omega$

PARAMETER		TEST CONDITIONS	MIN	TYP	MAX	UNIT
$P_O$	Output power (each channel)	$\text{THD} \leq 0.1\%$		70†		mW
THD+N	Total harmonic distortion + noise	$P_O = 150\text{ mW}$ , 20–20 kHz		2%		
B <sub>OM</sub>	Maximum output power BW	$G = 10$ , THD <5%		>20		kHz
	Phase margin	Open loop		56°		
$S_{VRR}$	Supply ripple rejection	$f = 1\text{ kHz}$		68		dB
	Channel/channel output separation	$f = 1\text{ kHz}$		86		dB
SNR	Signal-to-noise ratio	$P_O = 150\text{ mW}$		100		dB
$V_n$	Noise output voltage			9.5		$\mu\text{V}(\text{rms})$

† Measured at 1 kHz



# TPA112

## 150-mW STEREO AUDIO POWER AMPLIFIER

SLOS212C – AUGUST 1998 – REVISED MARCH 2000

### ac operating characteristics, $V_{DD} = 3.3\text{ V}$ , $T_A = 25^\circ\text{C}$ , $R_L = 32\ \Omega$

PARAMETER		TEST CONDITIONS	MIN	TYP	MAX	UNIT
$P_O$	Output power (each channel)	THD $\leq 0.1\%$		40†		mW
THD+N	Total harmonic distortion + noise	$P_O = 30\text{ mW}$ , 20–20 kHz		0.5%		
BOM	Maximum output power BW	$G = 10$ , THD $< 2\%$		$> 20$		kHz
	Phase margin	Open loop		$58^\circ$		
SVRR	Supply ripple rejection	$f = 1\text{ kHz}$		68		dB
	Channel/channel output separation	$f = 1\text{ kHz}$		86		dB
SNR	Signal-to-noise ratio	$P_O = 100\text{ mW}$		100		dB
$V_n$	Noise output voltage			9.5		$\mu\text{V(rms)}$

† Measured at 1 kHz

### ac operating characteristics, $V_{DD} = 5\text{ V}$ , $T_A = 25^\circ\text{C}$ , $R_L = 32\ \Omega$

PARAMETER		TEST CONDITIONS	MIN	TYP	MAX	UNIT
$P_O$	Output power (each channel)	THD $\leq 0.1\%$		40†		mW
THD+N	Total harmonic distortion + noise	$P_O = 60\text{ mW}$ , 20–20 kHz		0.4%		
BOM	Maximum output power BW	$G = 10$ , THD $< 2\%$		$> 20$		kHz
	Phase margin	Open loop		$56^\circ$		
SVRR	Supply ripple rejection	$f = 1\text{ kHz}$		68		dB
	Channel/channel output separation	$f = 1\text{ kHz}$		86		dB
SNR	Signal-to-noise ratio	$P_O = 150\text{ mW}$		100		dB
$V_n$	Noise output voltage			9.5		$\mu\text{V(rms)}$

† Measured at 1 kHz



# TPA112

## 150-mW STEREO AUDIO POWER AMPLIFIER

SLOS212C – AUGUST 1998 – REVISED MARCH 2000

### TYPICAL CHARACTERISTICS

**Table of Graphs**

		FIGURE
THD+N	Total harmonic distortion plus noise	1, 2, 4, 5, 7, 8, 10, 11, 13, 14, 16, 17, 34, 36
		3, 6, 9, 12, 15, 18
PSSR	Power supply rejection ratio	19, 20
V <sub>n</sub>	Output noise voltage	21, 22
	Crosstalk	23 – 26, 37, 38
	Mute attenuation	27, 28
	Open-loop gain	29, 30
	Phase margin	29, 30
	Phase	39 – 44
	Output power	31, 32
I <sub>CC</sub>	Supply current	33
SNR	Signal-to-noise ratio	35
	Closed-loop gain	39 – 44
	Power dissipation/amplifier	45, 46



# TPA112 150-mW STEREO AUDIO POWER AMPLIFIER

SLOS212C – AUGUST 1998 – REVISED MARCH 2000

## TYPICAL CHARACTERISTICS

TOTAL HARMONIC DISTORTION PLUS NOISE  
vs  
FREQUENCY

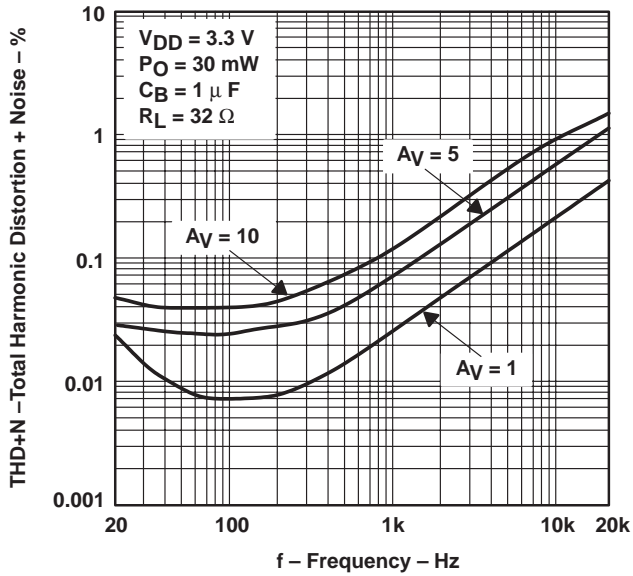

Figure 1

TOTAL HARMONIC DISTORTION PLUS NOISE  
vs  
FREQUENCY

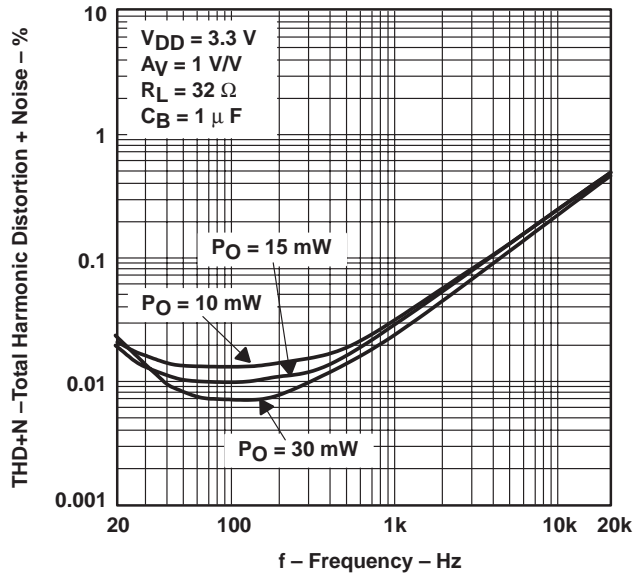

Figure 2

TOTAL HARMONIC DISTORTION PLUS NOISE  
vs  
OUTPUT POWER

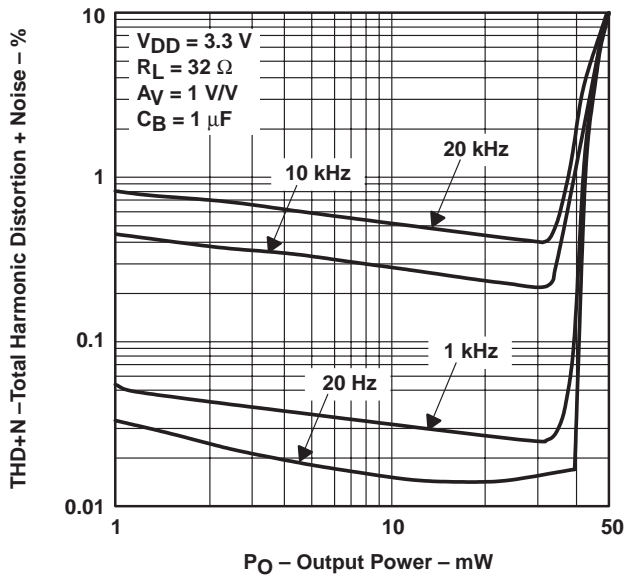

Figure 3

TOTAL HARMONIC DISTORTION PLUS NOISE  
vs  
FREQUENCY

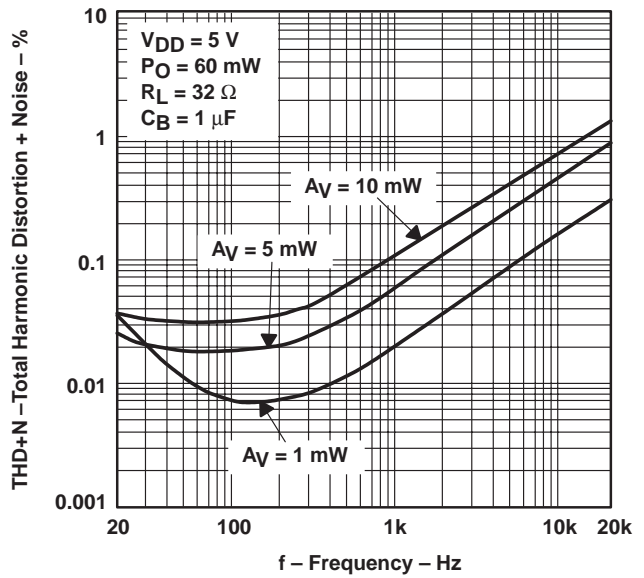

Figure 4



POST OFFICE BOX 655303 • DALLAS, TEXAS 75265

TYPICAL CHARACTERISTICS

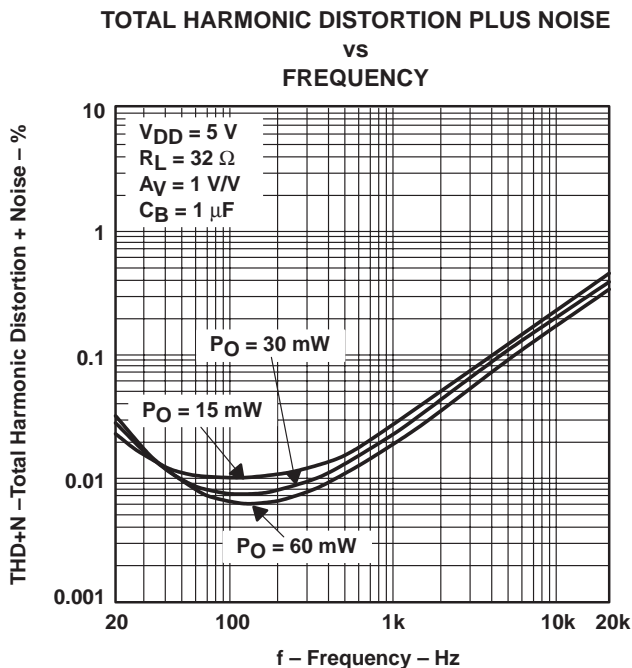

Figure 5

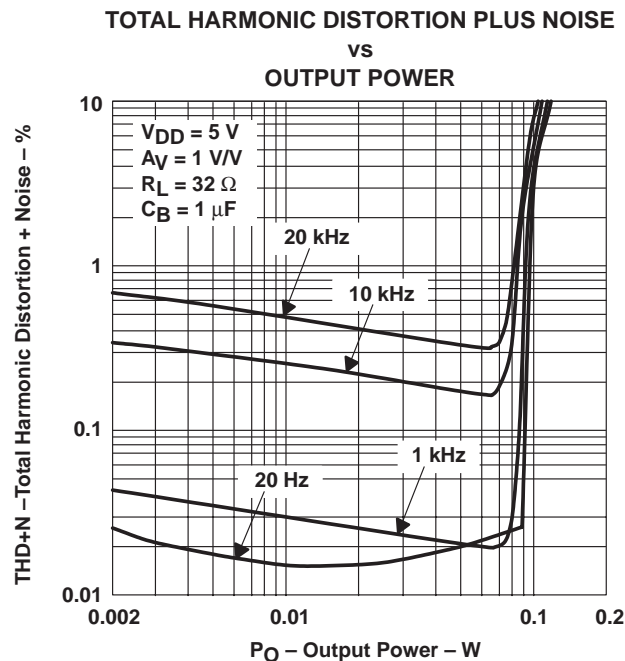

Figure 6

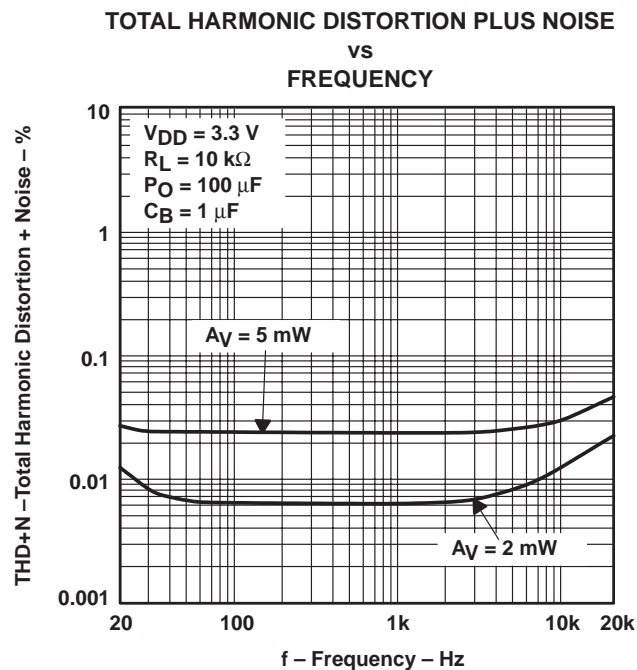

Figure 7

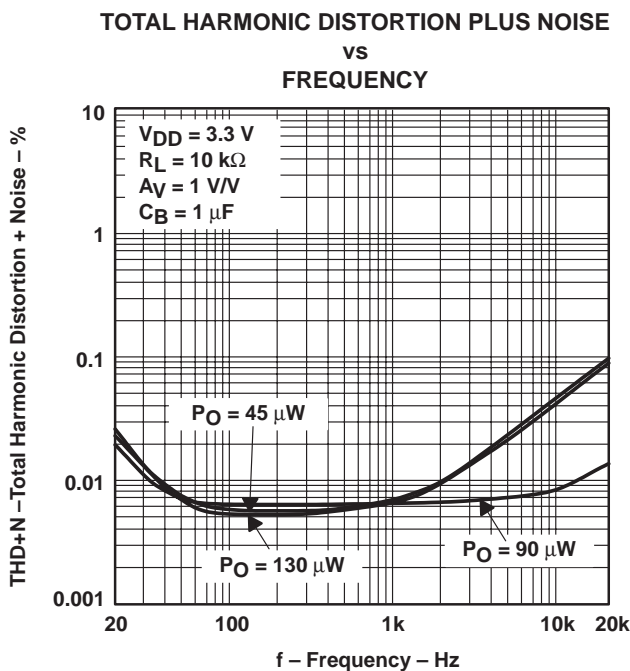

Figure 8

# TPA112 150-mW STEREO AUDIO POWER AMPLIFIER

SLOS212C – AUGUST 1998 – REVISED MARCH 2000

## TYPICAL CHARACTERISTICS

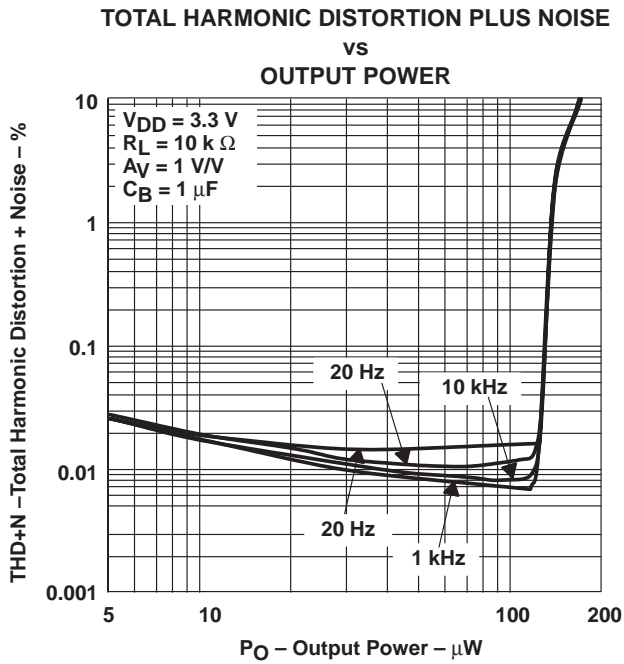

Figure 9

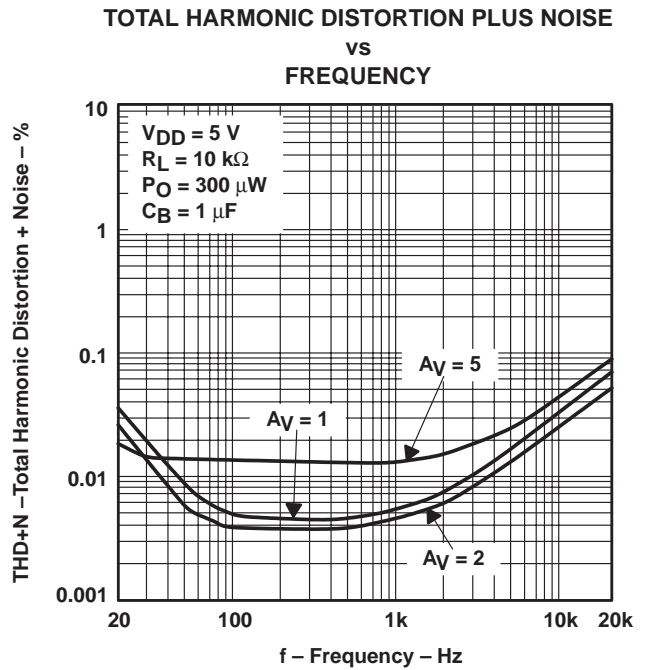

Figure 10

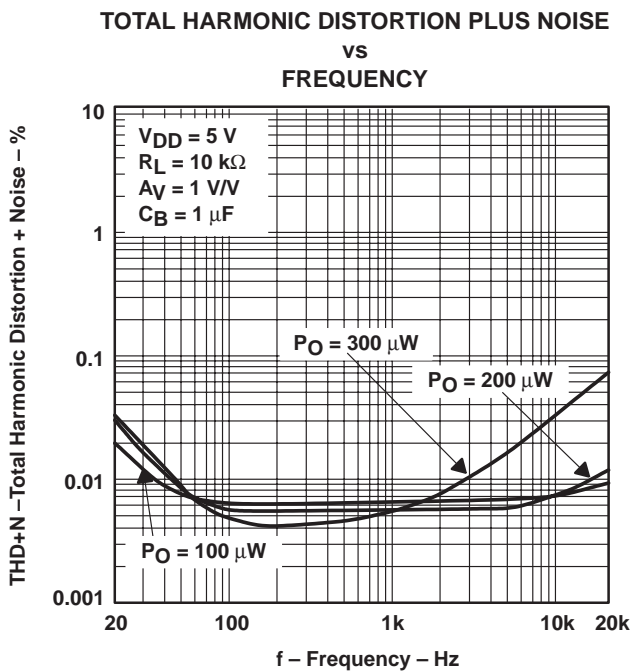

Figure 11

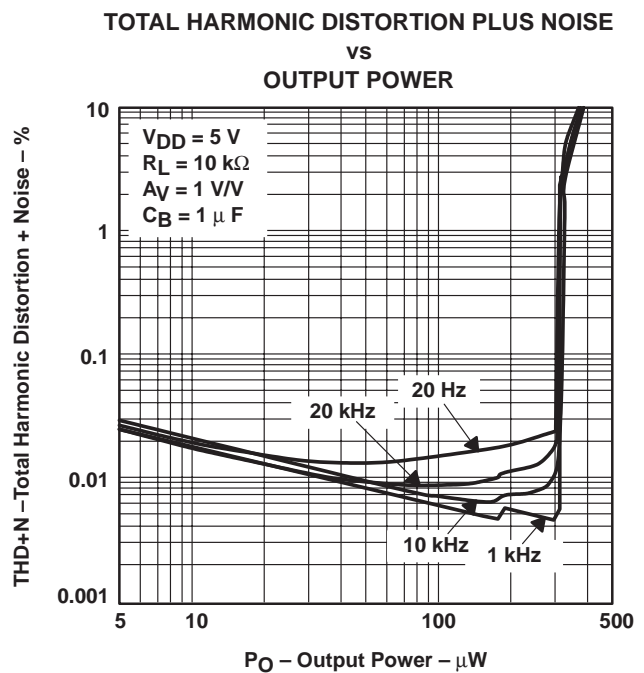

Figure 12



POST OFFICE BOX 655303 • DALLAS, TEXAS 75265



TYPICAL CHARACTERISTICS

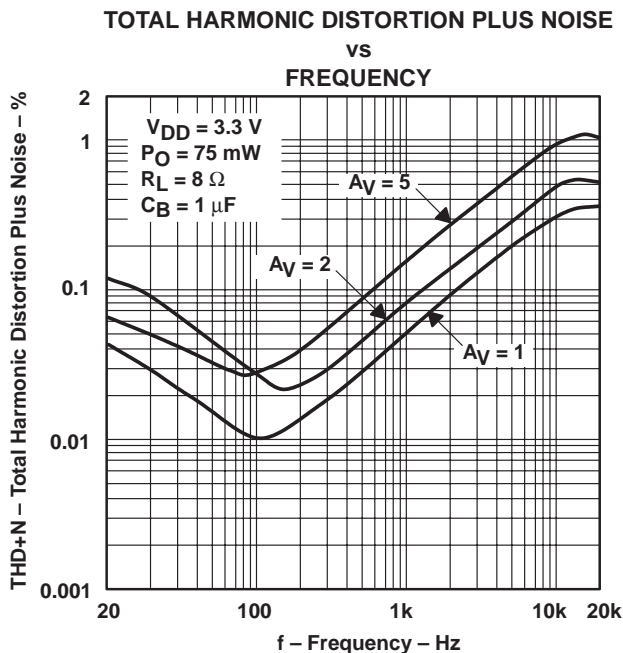

Figure 13

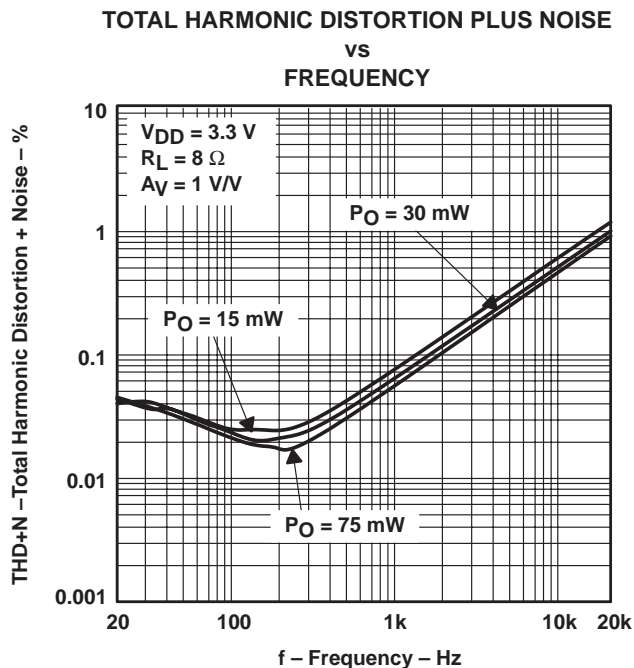

Figure 14

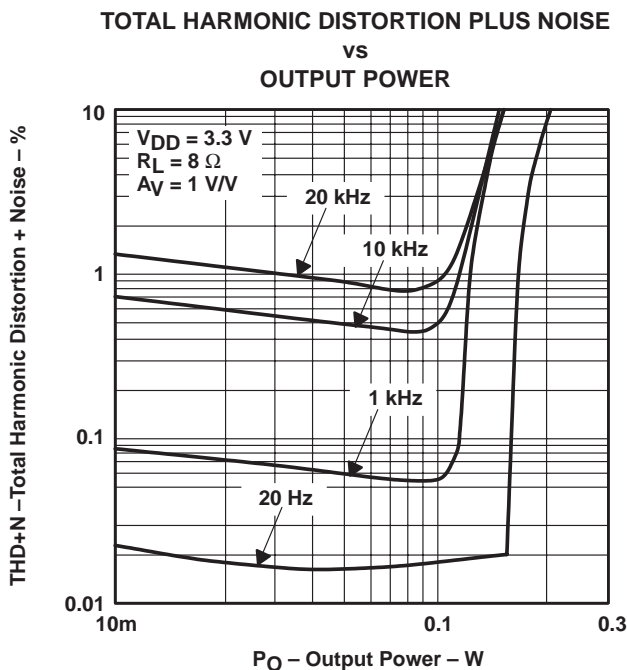

Figure 15

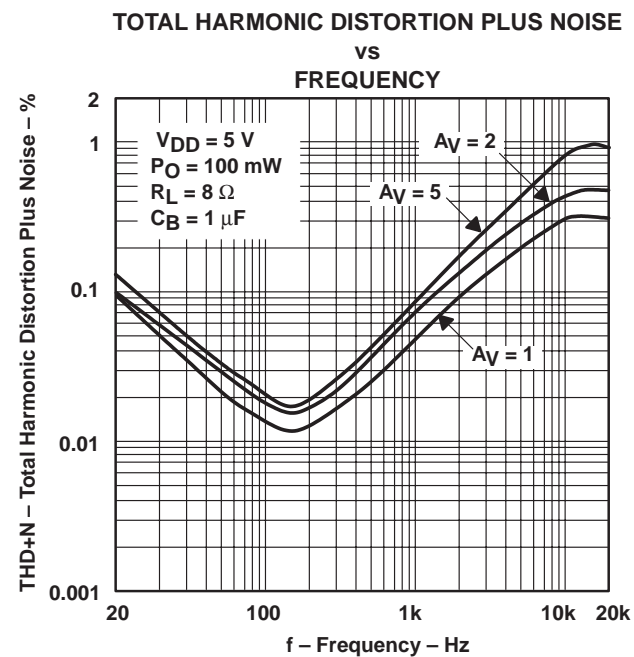

Figure 16

# TPA112 150-mW STEREO AUDIO POWER AMPLIFIER

SLOS212C – AUGUST 1998 – REVISED MARCH 2000

## TYPICAL CHARACTERISTICS

TOTAL HARMONIC DISTORTION PLUS NOISE  
vs  
FREQUENCY

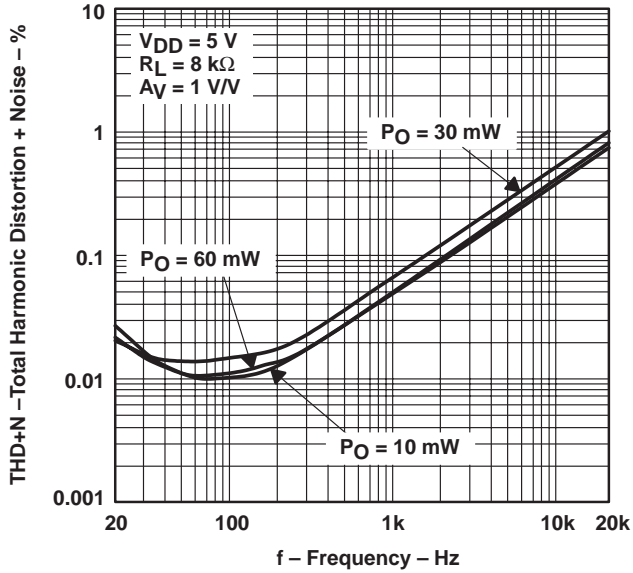

Figure 17

TOTAL HARMONIC DISTORTION PLUS NOISE  
vs  
POWER OUTPUT

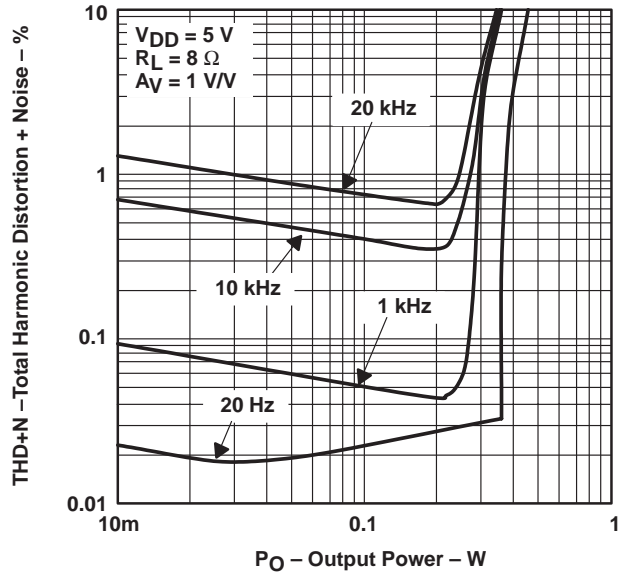

Figure 18

POWER SUPPLY REJECTION RATIO  
vs  
FREQUENCY

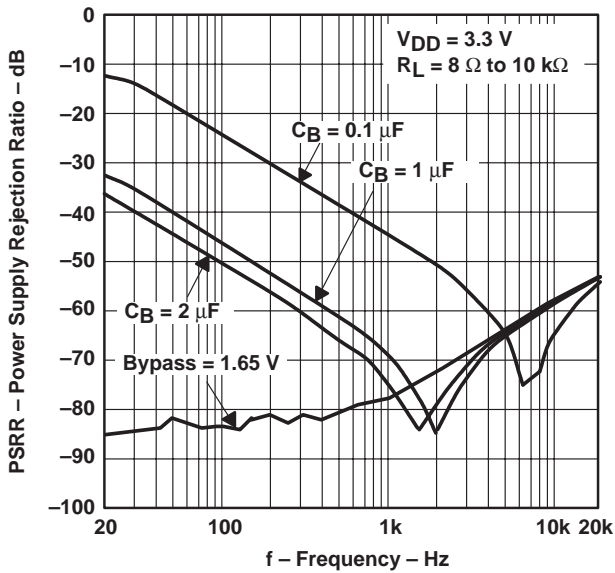

Figure 19

POWER SUPPLY REJECTION RATIO  
vs  
FREQUENCY

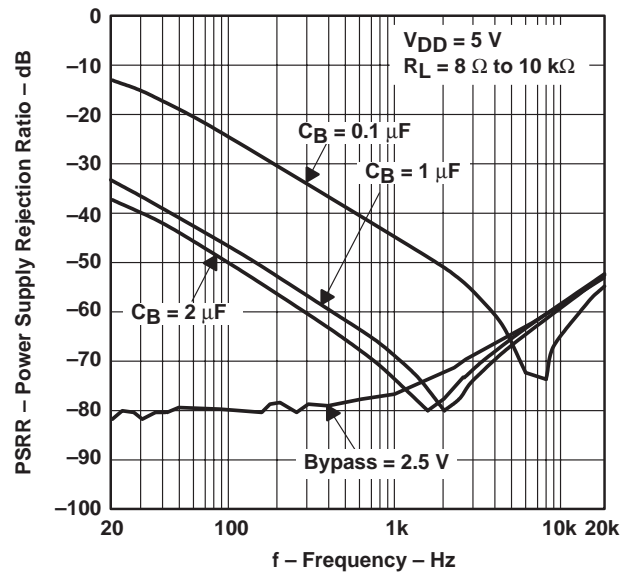

Figure 20



POST OFFICE BOX 655303 • DALLAS, TEXAS 75265

TYPICAL CHARACTERISTICS

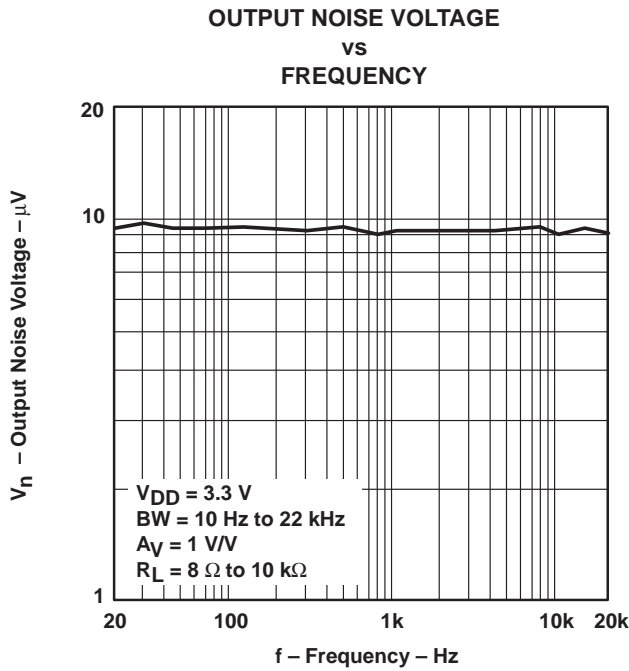

Figure 21

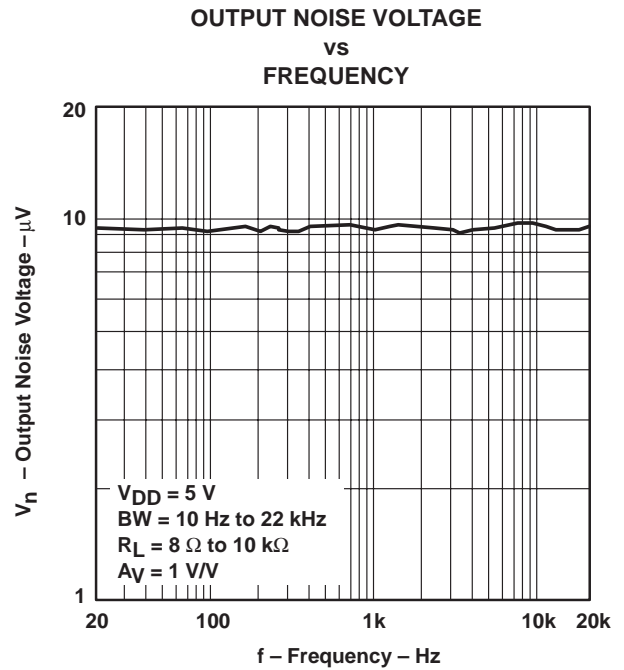

Figure 22

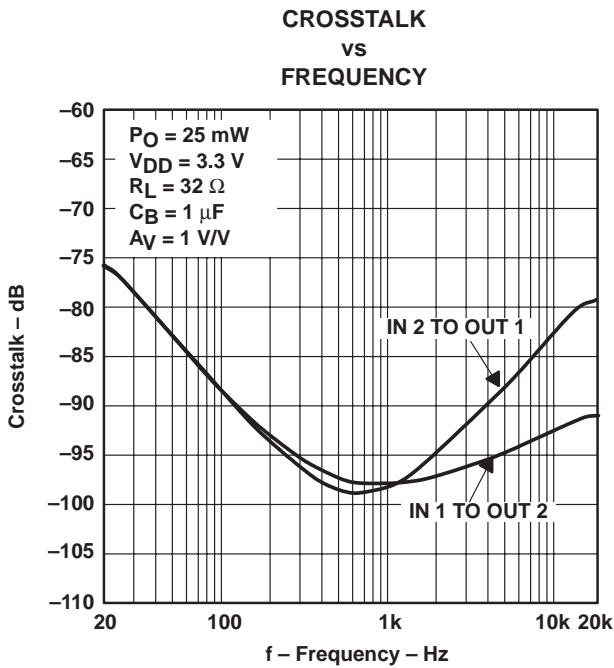

Figure 23

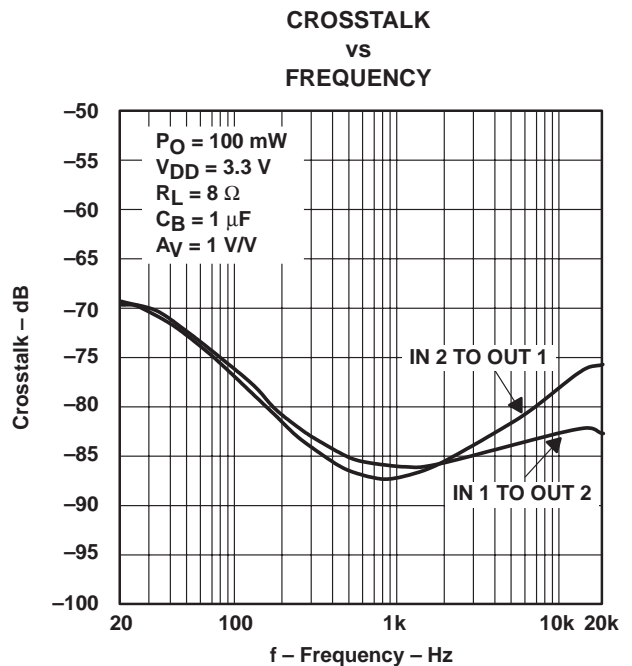

Figure 24

# TPA112 150-mW STEREO AUDIO POWER AMPLIFIER

SLOS212C – AUGUST 1998 – REVISED MARCH 2000

## TYPICAL CHARACTERISTICS

**CROSSTALK  
vs  
FREQUENCY**

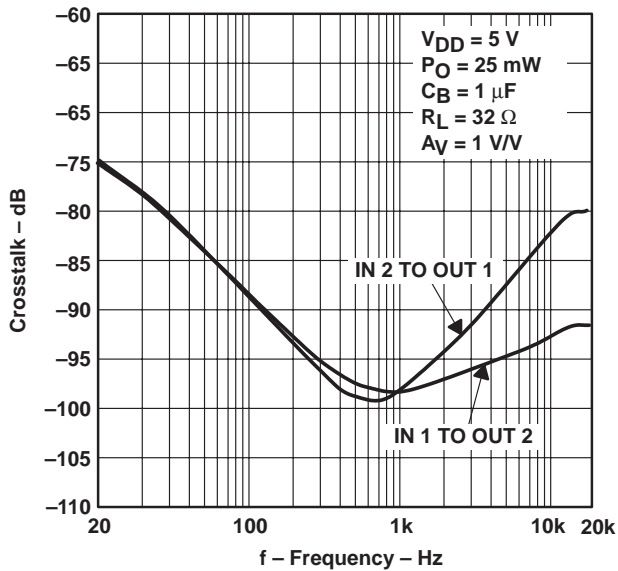

Figure 25

**CROSSTALK  
vs  
FREQUENCY**

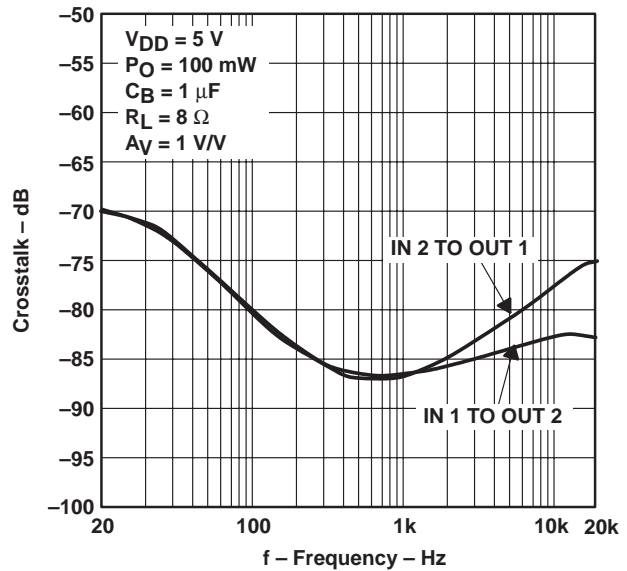

Figure 26

**MUTE ATTENUATION  
vs  
FREQUENCY**

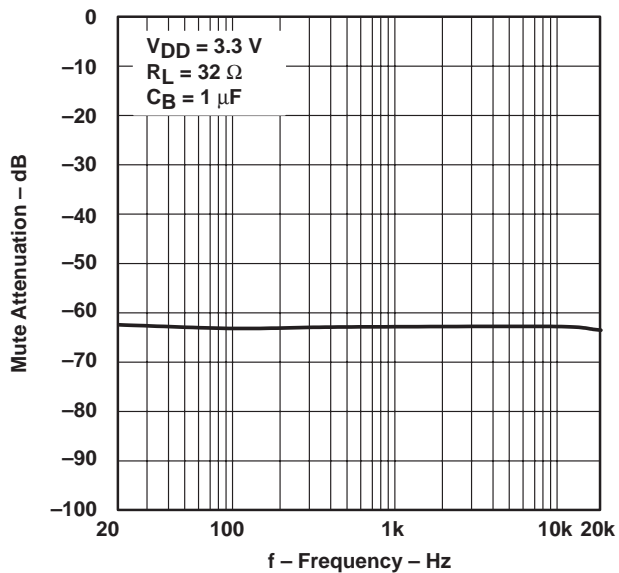

Figure 27

**MUTE ATTENUATION  
vs  
FREQUENCY**

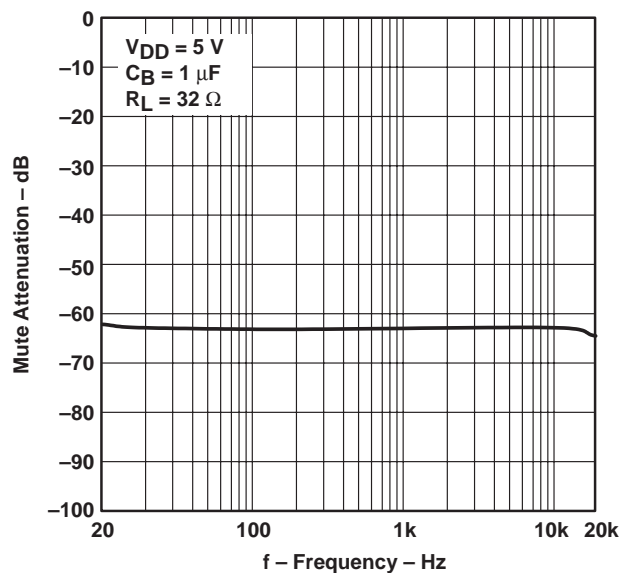

Figure 28



POST OFFICE BOX 655303 • DALLAS, TEXAS 75265

TYPICAL CHARACTERISTICS

OPEN-LOOP GAIN AND PHASE MARGIN  
vs  
FREQUENCY

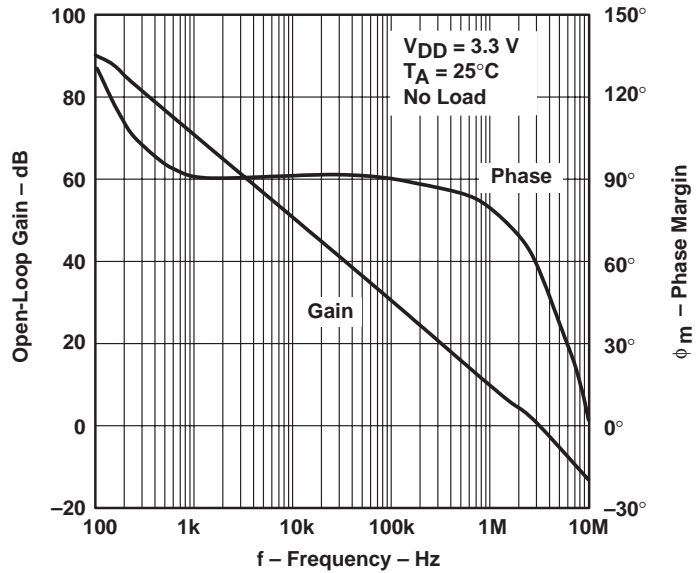

Figure 29

OPEN-LOOP GAIN AND PHASE MARGIN  
vs  
FREQUENCY

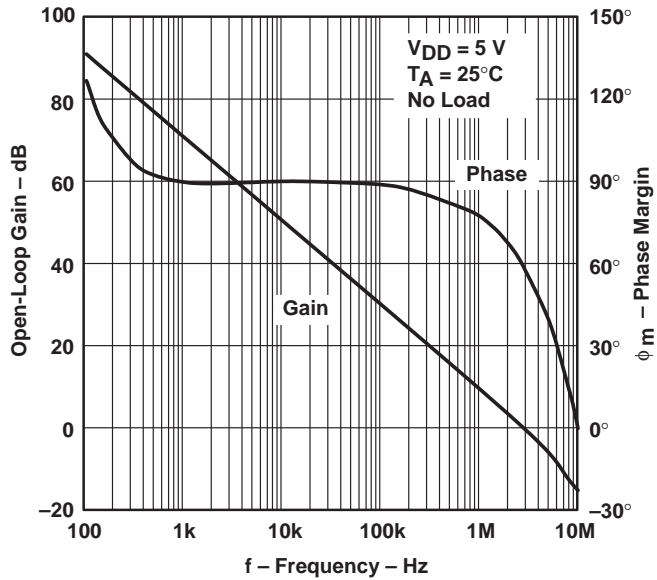

Figure 30

# TPA112 150-mW STEREO AUDIO POWER AMPLIFIER

SLOS212C – AUGUST 1998 – REVISED MARCH 2000

## TYPICAL CHARACTERISTICS

OUTPUT POWER  
vs  
LOAD RESISTANCE

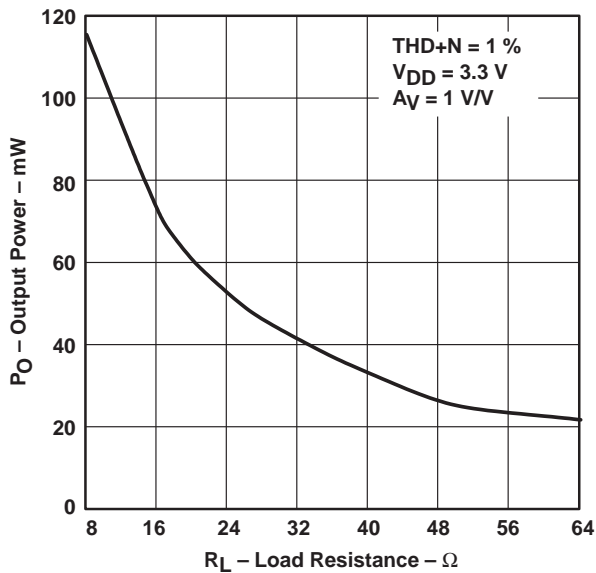

Figure 31

OUTPUT POWER  
vs  
LOAD RESISTANCE

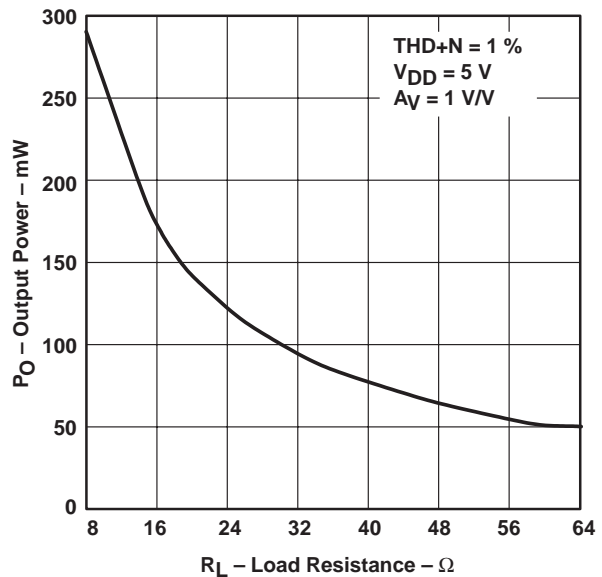

Figure 32

SUPPLY CURRENT  
vs  
SUPPLY VOLTAGE

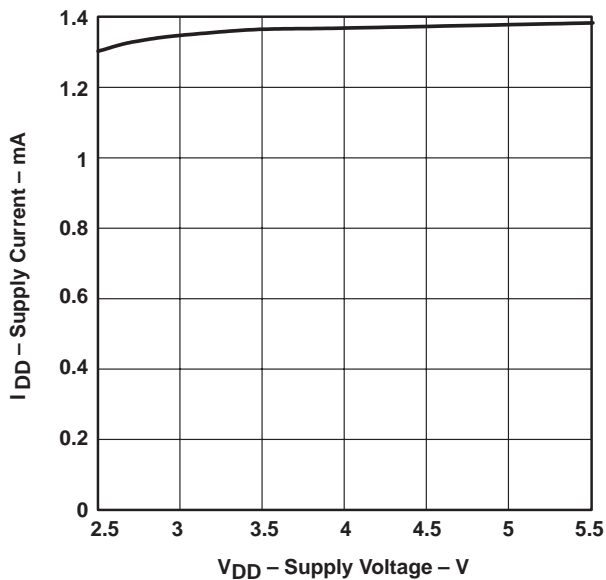

Figure 33

TOTAL HARMONIC DISTORTION PLUS NOISE  
vs  
FREQUENCY

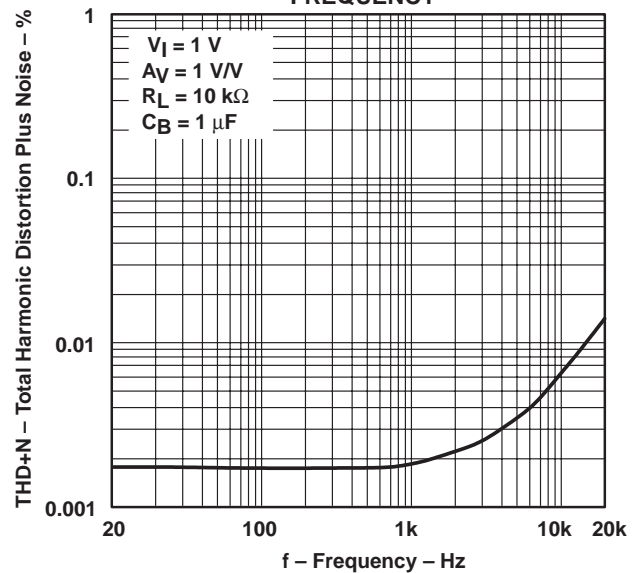
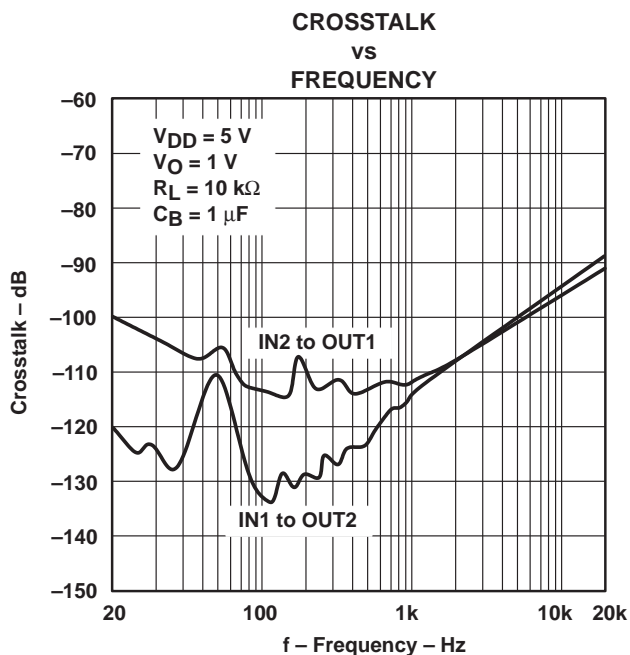
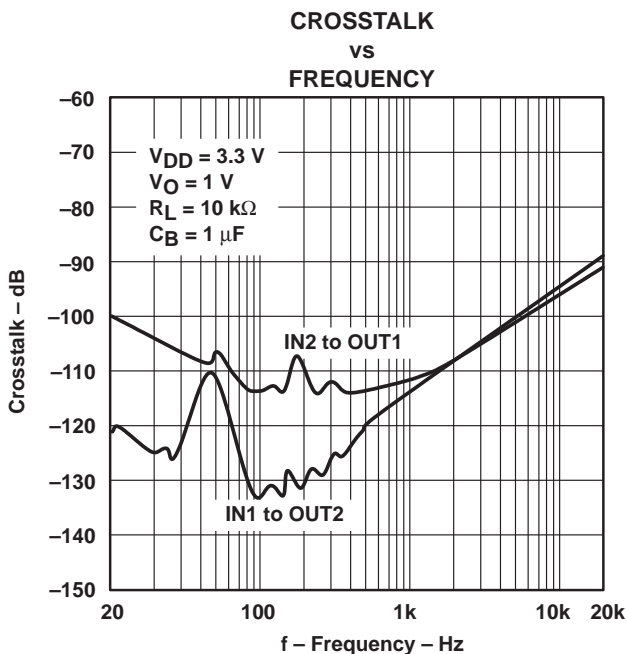
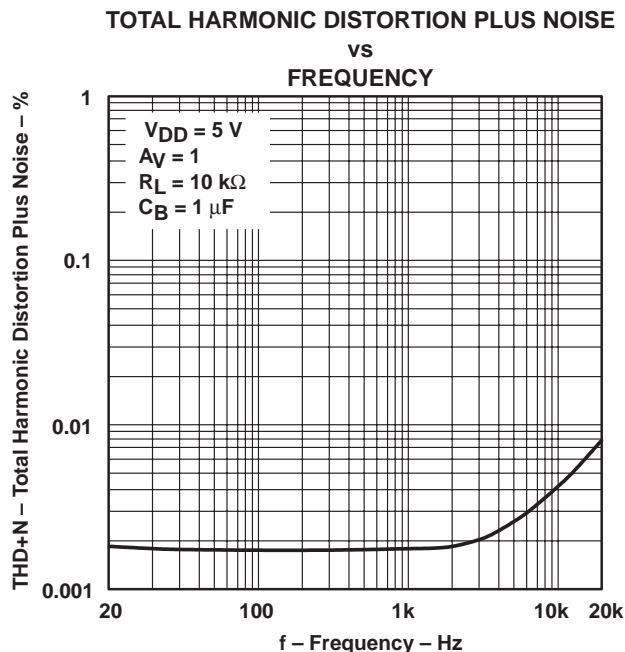
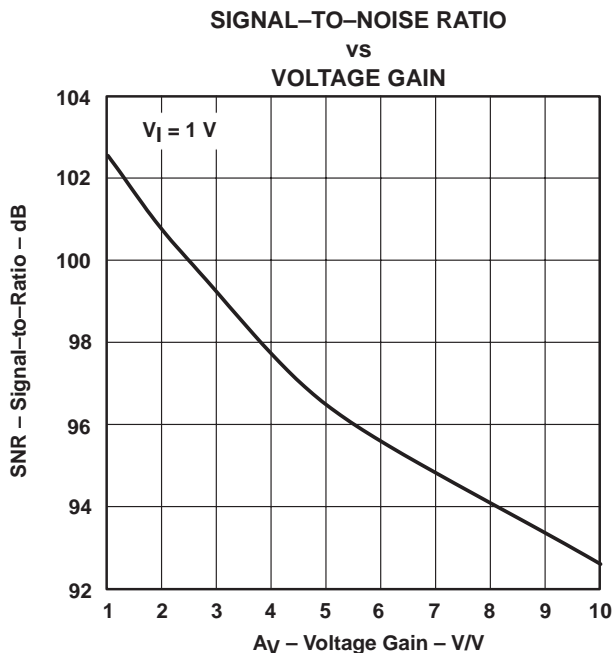

Figure 34



POST OFFICE BOX 655303 • DALLAS, TEXAS 75265

TYPICAL CHARACTERISTICS



**TPA112**  
**150-mW STEREO AUDIO POWER AMPLIFIER**

SLOS212C – AUGUST 1998 – REVISED MARCH 2000

**TYPICAL CHARACTERISTICS**

**CLOSED-LOOP GAIN AND PHASE**  
**vs**  
**FREQUENCY**

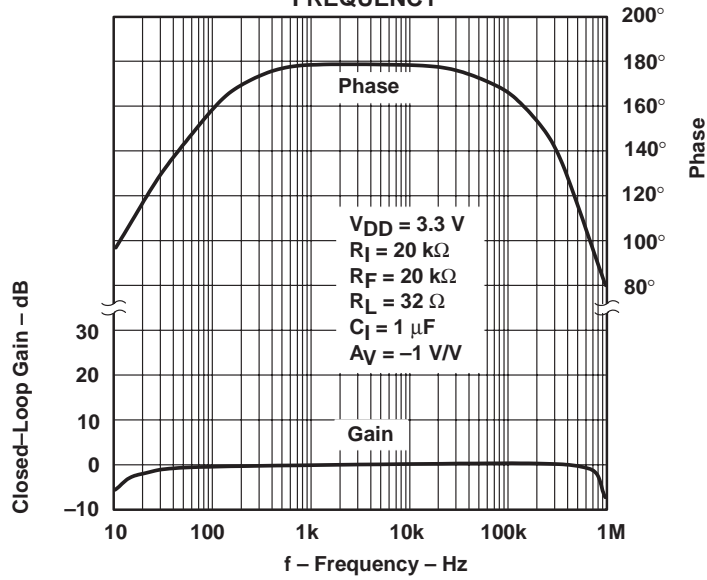

**Figure 39**

**CLOSED-LOOP GAIN AND PHASE**  
**vs**  
**FREQUENCY**

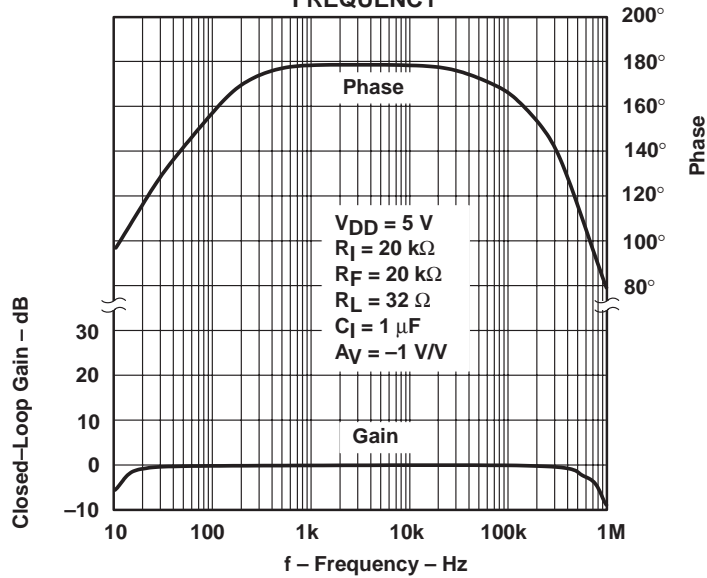

**Figure 40**



POST OFFICE BOX 655303 • DALLAS, TEXAS 75265



TYPICAL CHARACTERISTICS

CLOSED-LOOP GAIN AND PHASE  
vs  
FREQUENCY

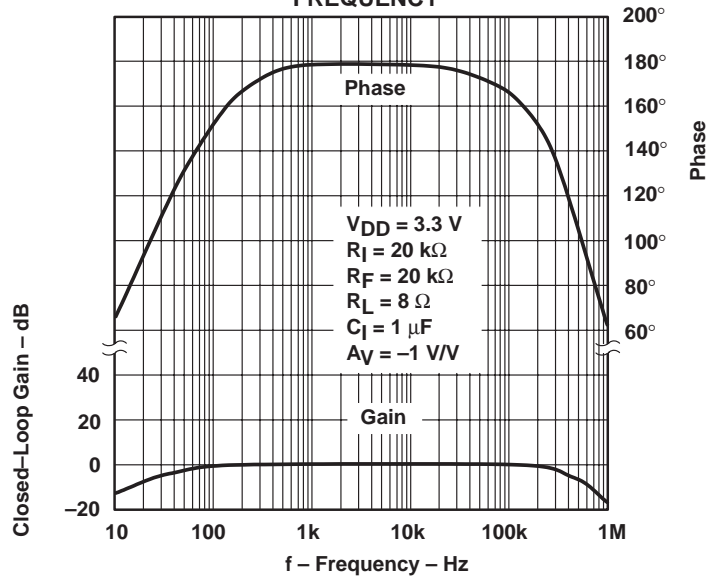

Figure 41

CLOSED-LOOP GAIN AND PHASE  
vs  
FREQUENCY

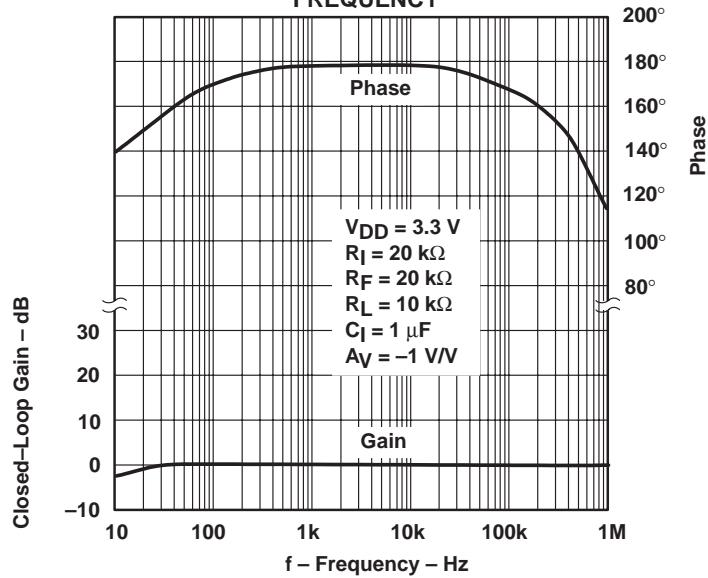

Figure 42

# TPA112 150-mW STEREO AUDIO POWER AMPLIFIER

SLOS212C – AUGUST 1998 – REVISED MARCH 2000

## TYPICAL CHARACTERISTICS

### CLOSED-LOOP GAIN AND PHASE vs FREQUENCY

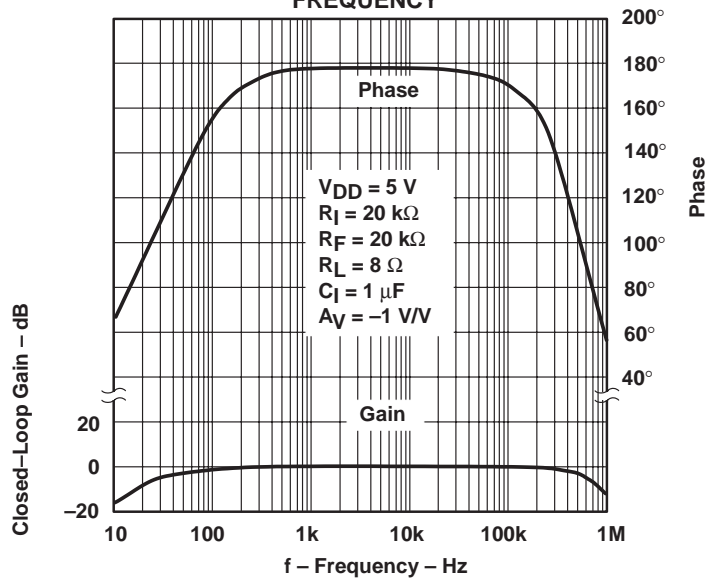

Figure 43

### CLOSED-LOOP GAIN AND PHASE vs FREQUENCY

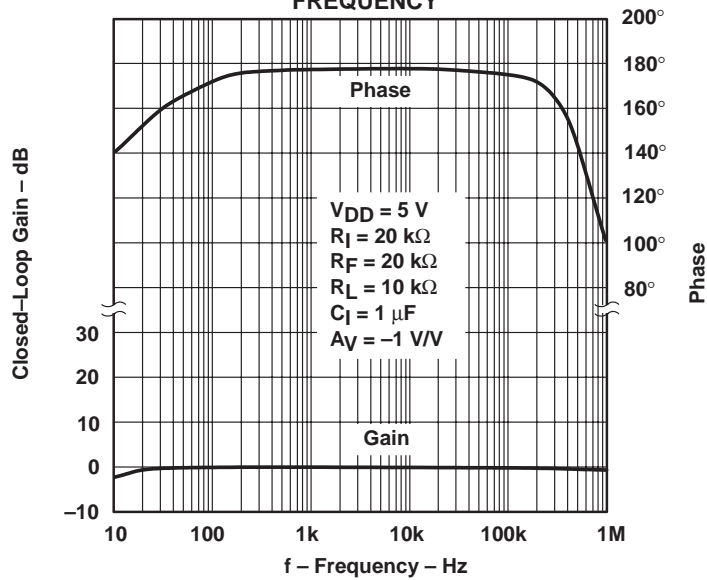

Figure 44



POST OFFICE BOX 655303 • DALLAS, TEXAS 75265

TYPICAL CHARACTERISTICS

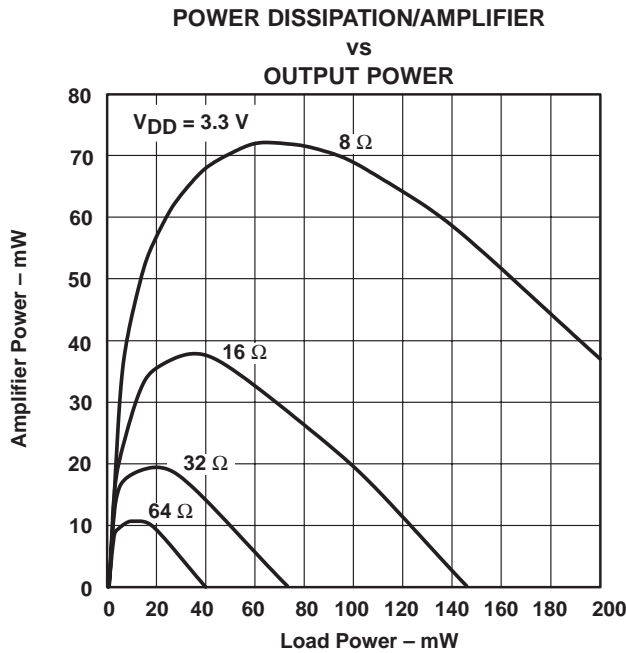

Figure 45

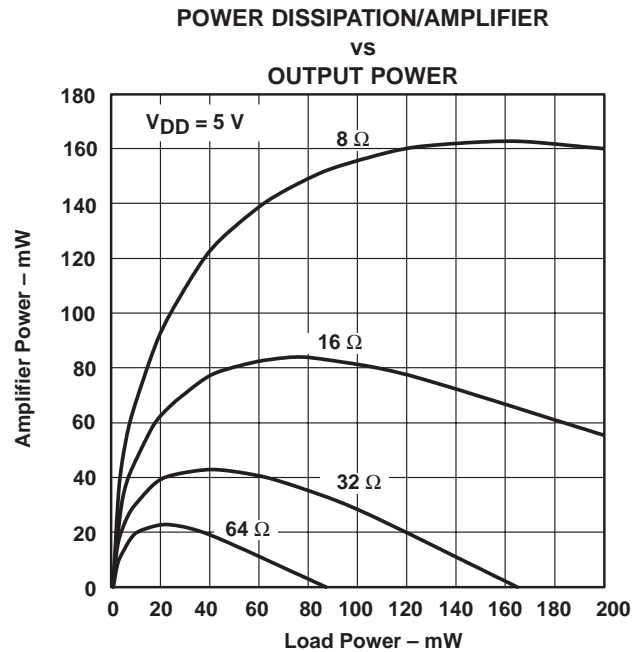

Figure 46

APPLICATION INFORMATION

gain setting resistors,  $R_F$  and  $R_I$

The gain for the TPA112 is set by resistors  $R_F$  and  $R_I$  according to equation 1.

$$\text{Gain} = - \left( \frac{R_F}{R_I} \right) \tag{1}$$

Given that the TPA112 is a MOS amplifier, the input impedance is very high. Consequently input leakage currents are not generally a concern, although noise in the circuit increases as the value of  $R_F$  increases. In addition, a certain range of  $R_F$  values is required for proper start-up operation of the amplifier. Taken together it is recommended that the effective impedance seen by the inverting node of the amplifier be set between 5 k $\Omega$  and 20 k $\Omega$ . The effective impedance is calculated in equation 2.

$$\text{Effective Impedance} = \frac{R_F R_I}{R_F + R_I} \tag{2}$$

As an example, consider an input resistance of 20 k $\Omega$  and a feedback resistor of 20 k $\Omega$ . The gain of the amplifier would be  $-1$  and the effective impedance at the inverting terminal would be 10 k $\Omega$ , which is within the recommended range.

**TPA112**  
**150-mW STEREO AUDIO POWER AMPLIFIER**

SLOS212C – AUGUST 1998 – REVISED MARCH 2000

---

**APPLICATION INFORMATION**

### gain setting resistors, $R_F$ and $R_I$ (continued)

For high performance applications, metal film resistors are recommended because they tend to have lower noise levels than carbon resistors. For values of  $R_F$  above 50 k $\Omega$ , the amplifier tends to become unstable due to a pole formed from  $R_F$  and the inherent input capacitance of the MOS input structure. For this reason, a small compensation capacitor of approximately 5 pF should be placed in parallel with  $R_F$ . This, in effect, creates a low-pass filter network with the cutoff frequency defined in equation 3.

$$f_{\text{co(lowpass)}} = \frac{1}{2\pi R_F C_F} \quad (3)$$

For example, if  $R_F$  is 100 k $\Omega$  and  $C_F$  is 5 pF then  $f_{\text{co(lowpass)}}$  is 318 kHz, which is well outside the audio range.

### input capacitor, $C_I$

In the typical application, an input capacitor,  $C_I$ , is required to allow the amplifier to bias the input signal to the proper dc level for optimum operation. In this case,  $C_I$  and  $R_I$  form a high-pass filter with the corner frequency determined in equation 4.

$$f_{\text{co(highpass)}} = \frac{1}{2\pi R_I C_I} \quad (4)$$

The value of  $C_I$  is important to consider, as it directly affects the bass (low frequency) performance of the circuit. Consider the example where  $R_I$  is 20 k $\Omega$  and the specification calls for a flat bass response down to 20 Hz. Equation 4 is reconfigured as equation 5.

$$C_I = \frac{1}{2\pi R_I f_{\text{co(highpass)}}} \quad (5)$$

In this example,  $C_I$  is 0.40  $\mu\text{F}$ , so one would likely choose a value in the range of 0.47  $\mu\text{F}$  to 1  $\mu\text{F}$ . A further consideration for this capacitor is the leakage path from the input source through the input network ( $R_I$ ,  $C_I$ ) and the feedback resistor ( $R_F$ ) to the load. This leakage current creates a dc offset voltage at the input to the amplifier that reduces useful headroom, especially in high-gain applications ( $> 10$ ). For this reason a low-leakage tantalum or ceramic capacitor is the best choice. When polarized capacitors are used, the positive side of the capacitor should face the amplifier input in most applications, as the dc level there is held at  $V_{DD}/2$ , which is likely higher than the source dc level. It is important to confirm the capacitor polarity in the application.

### power supply decoupling, $C_S$

The TPA112 is a high-performance CMOS audio amplifier that requires adequate power supply decoupling to ensure that the output total harmonic distortion (THD) is as low as possible. Power supply decoupling also prevents oscillations for long lead lengths between the amplifier and the speaker. The optimum decoupling is achieved by using two capacitors of different types that target different types of noise on the power supply leads. For higher frequency transients, spikes, or digital hash on the line, a good low equivalent-series-resistance (ESR) ceramic capacitor, typically 0.1  $\mu\text{F}$ , placed as close as possible to the device  $V_{DD}$  lead, works best. For filtering lower-frequency noise signals, a larger aluminum electrolytic capacitor of 10  $\mu\text{F}$  or greater placed near the power amplifier is recommended.

# TPA112

## 150-mW STEREO AUDIO POWER AMPLIFIER

SLOS212C – AUGUST 1998 – REVISED MARCH 2000

### APPLICATION INFORMATION

#### midrail voltage

The TPA112 is a single-supply amplifier, so it must be properly biased to accommodate audio signals. Normally, the amplifier is biased at  $V_{DD}/2$ , but it can actually be biased at any voltage between  $V_{DD}$  and ground. However, biasing the amplifier at a point other than  $V_{DD}/2$  will reduce the amplifier's maximum output swing. In some applications where the circuitry driving the TPA112 has a different midrail voltage, it might make sense to use the same midrail voltage for the TPA112, and possibly eliminate the use of the dc-blocking caps.

There are two concerns with the midrail voltage source: the amount of noise present, and its output impedance. Any noise present on the midrail voltage source that is not present on the audio input signal will be input to the amplifier, and passed to the output (and increased by the gain of the circuit). Common-mode noise will be cancelled out by the differential configuration of the circuit.

The output impedance of the circuit used to generate the midrail voltage needs to be low enough so as not to be influenced by the audio signal path. A common method of generating the midrail voltage is to form a voltage divider from the supply to ground, with a bypass capacitor from the common node to ground. This capacitor improves the PSRR of the circuit. However, this circuit has a limited range of output impedances, so to achieve very low output impedances, the voltage generated by the voltage divider is fed into a unity-gain amplifier to lower the output impedance of the circuit.

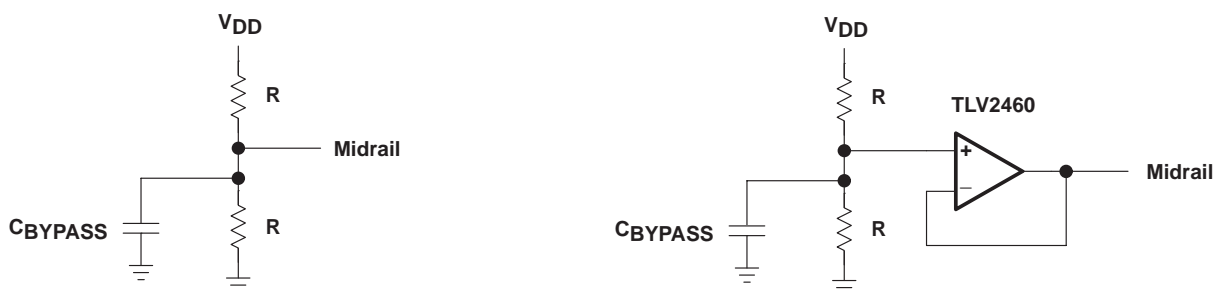

a) Midrail Voltage Generator Using a Simple Resistor-Divider

b) Buffered Midrail Voltage Generator to Provide Low Output Impedance

**Figure 47. Midrail Voltage Generator**

If a voltage step is applied to a speaker, it will pop. To reduce popping, the midrail voltage should rise at a sub-sonic rate; that is, a rate less than the rise time of a 20-Hz waveform. If the voltage rises faster than that, there is the possibility of a pop from the speaker.

Pop can also be heard in the speaker if the midrail voltage rises faster than either the input coupling capacitor, or the output coupling capacitor. If midrail rises first, then the charging of the input and output capacitors will be heard in the speaker. To keep this noise as low as possible, the relationship shown in equation 6 should be maintained.

$$\frac{1}{(C_B \times R_{SOURCE})} \leq \frac{1}{(C_I R_I)} \ll \frac{1}{R_L C_C} \quad (6)$$

Where  $C_{BYPASS}$  is the value of the bypass capacitor, and  $R_{SOURCE}$  is the equivalent source impedance of the voltage divider (the parallel combination of the two resistors). For example, if the voltage divider is constructed using two 20-k $\Omega$  resistors, then  $R_{SOURCE}$  is 10 k $\Omega$ .

## APPLICATION INFORMATION

### midrail bypass capacitor, $C_B$

The midrail bypass capacitor,  $C_B$ , serves several important functions. During start-up,  $C_B$  determines the rate at which the amplifier starts up. This helps to push the start-up pop noise into the subaudible range (so slow it can not be heard). The second function is to reduce noise produced by the power supply caused by coupling into the output drive signal. This noise is from the midrail generation circuit internal to the amplifier. The capacitor is fed from the resistor divider with equivalent resistance of  $R_{SOURCE}$ . To keep the start-up pop as low as possible, the relationship shown in equation 7 should be maintained.

$$\frac{1}{(C_B \times R_{SOURCE})} \leq \frac{1}{(C_I R_I)} \quad (7)$$

As an example, consider a circuit where  $C_B$  is 1  $\mu\text{F}$ ,  $R_{SOURCE} = 160 \text{ k}\Omega$ ,  $C_I$  is 1  $\mu\text{F}$ , and  $R_I$  is 20  $\text{k}\Omega$ . Inserting these values into the equation 9 results in:

$$6.25 \leq 50$$

which satisfies the rule. Bypass capacitor,  $C_B$ , values of 0.1  $\mu\text{F}$  to 1  $\mu\text{F}$  ceramic or tantalum low-ESR capacitors are recommended for the best THD and noise performance.

### output coupling capacitor, $C_C$

In the typical single-supply single-ended (SE) configuration, an output coupling capacitor ( $C_C$ ) is required to block the dc bias at the output of the amplifier, thus preventing dc currents in the load. As with the input coupling capacitor, the output coupling capacitor and impedance of the load form a high-pass filter governed by equation 8.

$$f_{(\text{out high})} = \frac{1}{2\pi R_L C_C} \quad (8)$$

The main disadvantage, from a performance standpoint, is that the typically small load impedances drive the low-frequency corner higher. Large values of  $C_C$  are required to pass low frequencies into the load. Consider the example where a  $C_C$  of 68  $\mu\text{F}$  is chosen and loads vary from 32  $\Omega$  to 47  $\text{k}\Omega$ . Table 1 summarizes the frequency response characteristics of each configuration.

**Table 1. Common Load Impedances vs Low Frequency Output Characteristics in SE Mode**

$R_L$	$C_C$	Lowest Frequency
32 $\Omega$	68 $\mu\text{F}$	73 Hz
10,000 $\Omega$	68 $\mu\text{F}$	0.23 Hz
47,000 $\Omega$	68 $\mu\text{F}$	0.05 Hz

As Table 1 indicates, headphone response is adequate and drive into line level inputs (a home stereo for example) is very good.

**TPA112**  
**150-mW STEREO AUDIO POWER AMPLIFIER**

SLOS212C – AUGUST 1998 – REVISED MARCH 2000

---

**APPLICATION INFORMATION**



### output coupling capacitor, $C_C$ (continued)

The output coupling capacitor required in single-supply SE mode also places additional constraints on the selection of other components in the amplifier circuit. With the rules described earlier still valid, add the following relationship:

#### output pull-down resistor, $R_C + R_O$

Placing a 100- $\Omega$  resistor,  $R_C$ , from the output side of the coupling capacitor to ground insures the coupling capacitor,  $C_C$ , is charged before a plug is inserted into the jack. Without this resistor, the coupling capacitor would charge rapidly upon insertion of a plug, leading to an audible pop in the headphones.

Placing a 20-k $\Omega$  resistor,  $R_O$ , from the output of the IC to ground insures that the coupling capacitor fully discharges at power down. If the supply is rapidly cycled without this capacitor, a small pop may be audible in 10-k $\Omega$  loads.

#### using low-ESR capacitors

Low-ESR capacitors are recommended throughout this application. A real capacitor can be modeled simply as a resistor in series with an ideal capacitor. The voltage drop across this resistor minimizes the beneficial effects of the capacitor in the circuit. The lower the equivalent value of this resistance, the more the real capacitor behaves like an ideal capacitor.

### 5-V versus 3.3-V operation

The TPA112 was designed for operation over a supply range of 2.7 V to 5.5 V. This data sheet provides full specifications for 5-V and 3.3-V operation since these are considered to be the two most common standard voltages. There are no special considerations for 3.3-V versus 5-V operation as far as supply bypassing, gain setting, or stability. Supply current is slightly reduced from 3.5 mA (typical) to 2.5 mA (typical). The most important consideration is that of output power. Each amplifier in the TPA112 can produce a maximum voltage swing of  $V_{DD} - 1$  V. This means, for 3.3-V operation, clipping starts to occur when  $V_{O(PP)} = 2.3$  V as opposed when  $V_{O(PP)} = 4$  V while operating at 5 V. The reduced voltage swing subsequently reduces maximum output power into the load before distortion begins to become significant.

**TPA112**  
**150-mW STEREO AUDIO POWER AMPLIFIER**

SLOS212C – AUGUST 1998 – REVISED MARCH 2000

**MECHANICAL DATA**

**D (R-PDSO-G\*\*)**

**PLASTIC SMALL-OUTLINE PACKAGE**

14 PINS SHOWN

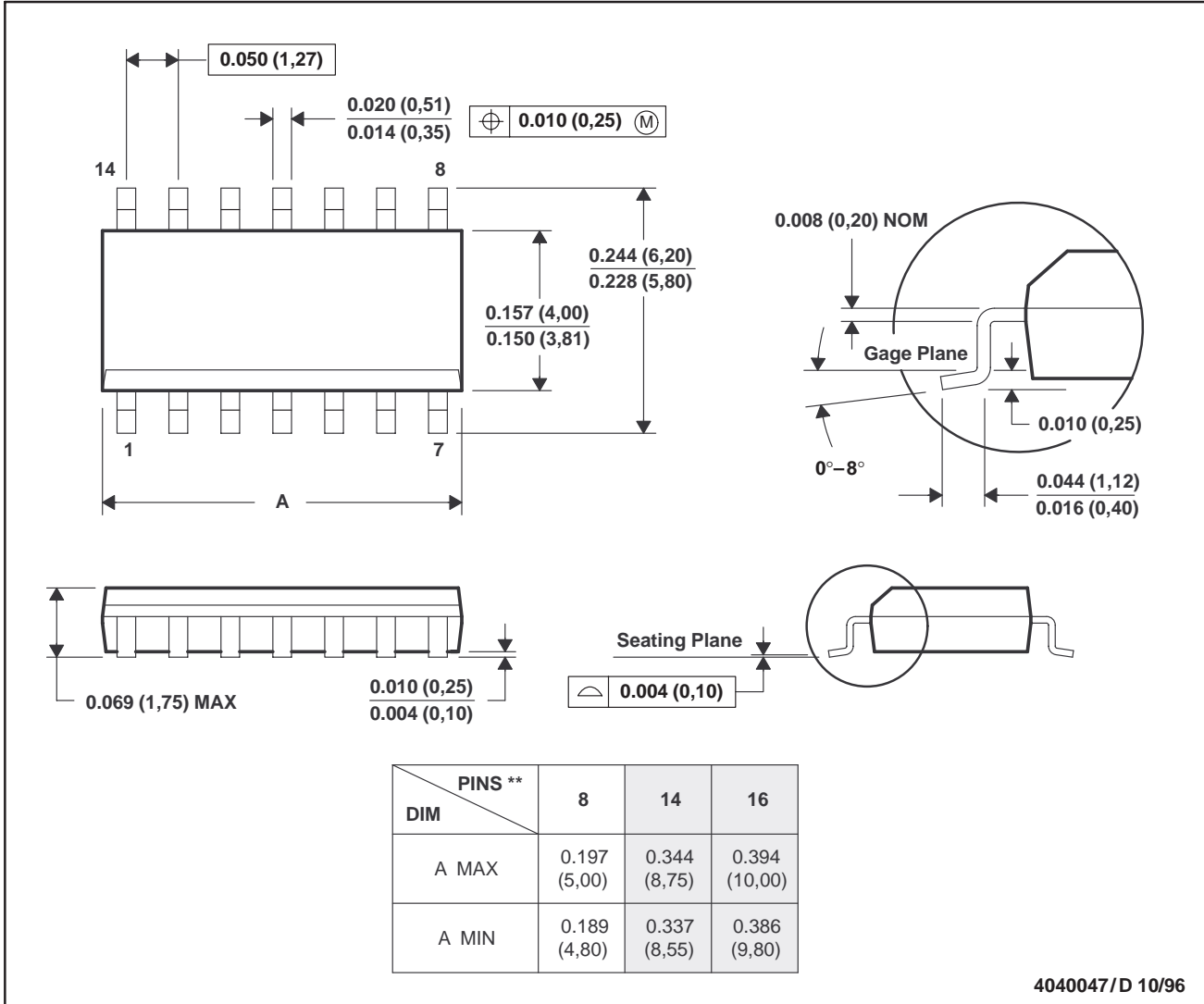

4040047/D 10/96

- NOTES: A. All linear dimensions are in inches (millimeters).  
 B. This drawing is subject to change without notice.  
 C. Body dimensions do not include mold flash or protrusion, not to exceed 0.006 (0,15).  
 D. Falls within JEDEC MS-012



POST OFFICE BOX 655303 • DALLAS, TEXAS 75265

# TPA112 150-mW STEREO AUDIO POWER AMPLIFIER

SLOS212C – AUGUST 1998 – REVISED MARCH 2000

## MECHANICAL DATA

DGN (S-PDSO-G8)

PowerPAD™ PLASTIC SMALL-OUTLINE PACKAGE

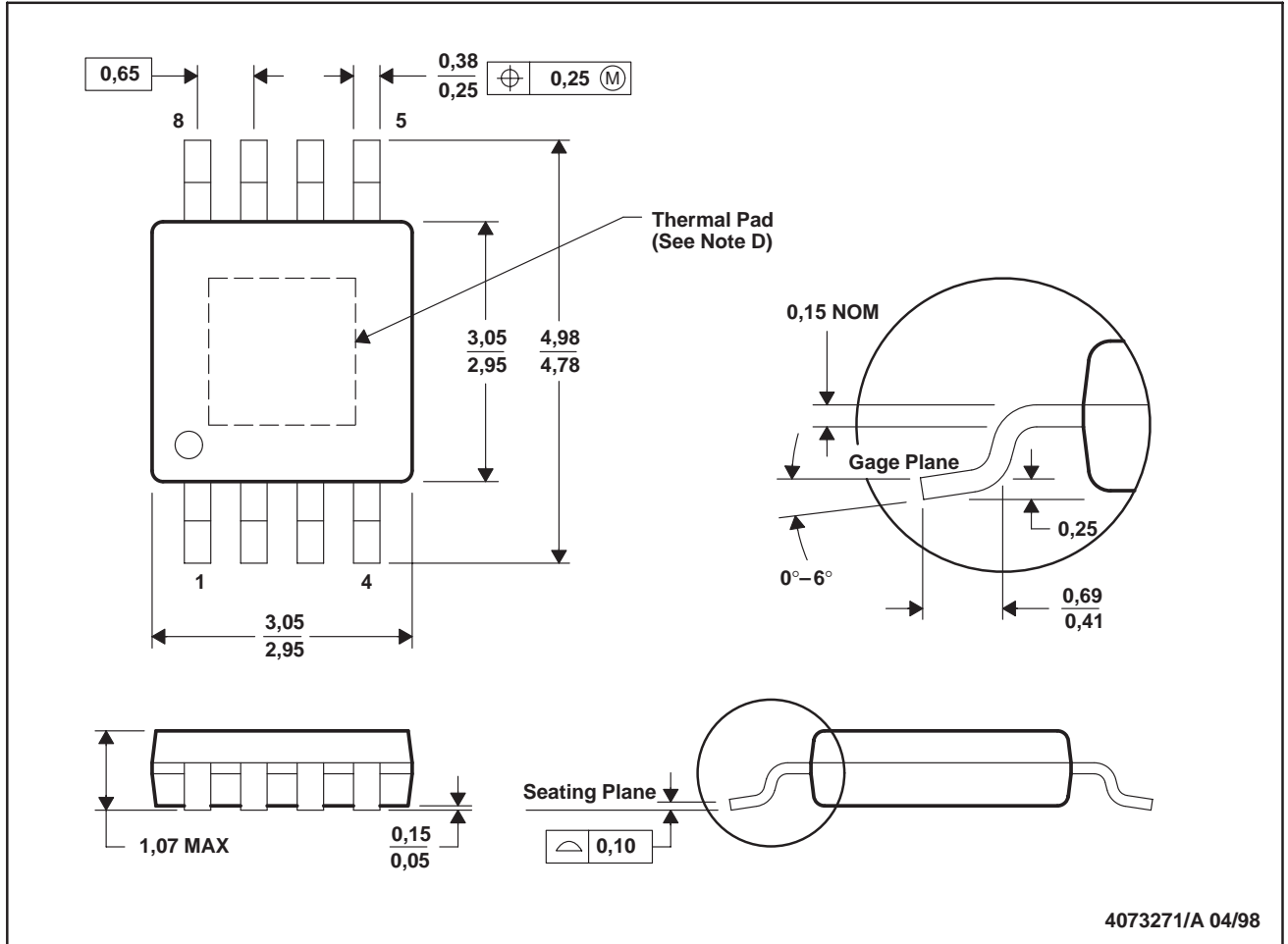

- NOTES: A. All linear dimensions are in millimeters.  
 B. This drawing is subject to change without notice.  
 C. Body dimensions include mold flash or protrusions.  
 D. The package thermal performance may be enhanced by attaching an external heat sink to the thermal pad. This pad is electrically and thermally connected to the backside of the die and possibly selected leads.  
 E. Falls within JEDEC MO-187

PowerPAD is a trademark of Texas Instruments.



POST OFFICE BOX 655303 • DALLAS, TEXAS 75265

## **IMPORTANT NOTICE**

Texas Instruments and its subsidiaries (TI) reserve the right to make changes to their products or to discontinue any product or service without notice, and advise customers to obtain the latest version of relevant information to verify, before placing orders, that information being relied on is current and complete. All products are sold subject to the terms and conditions of sale supplied at the time of order acknowledgment, including those pertaining to warranty, patent infringement, and limitation of liability.

TI warrants performance of its semiconductor products to the specifications applicable at the time of sale in accordance with TI's standard warranty. Testing and other quality control techniques are utilized to the extent TI deems necessary to support this warranty. Specific testing of all parameters of each device is not necessarily performed, except those mandated by government requirements.

Customers are responsible for their applications using TI components.

In order to minimize risks associated with the customer's applications, adequate design and operating safeguards must be provided by the customer to minimize inherent or procedural hazards.

TI assumes no liability for applications assistance or customer product design. TI does not warrant or represent that any license, either express or implied, is granted under any patent right, copyright, mask work right, or other intellectual property right of TI covering or relating to any combination, machine, or process in which such semiconductor products or services might be or are used. TI's publication of information regarding any third party's products or services does not constitute TI's approval, warranty or endorsement thereof.