

# TPA0212

## STEREO 2-W AUDIO POWER AMPLIFIER WITH FOUR SELECTABLE GAIN SETTINGS AND MUX CONTROL

SLOS284 – NOVEMBER 1999

- **Compatible With PC 99 Desktop Line-Out Into 10-k $\Omega$  Load**
- **Internal Gain Control, Which Eliminates External Gain-Setting Resistors**
- **2-W/Ch Output Power Into 3- $\Omega$  Load**
- **Input MUX Select Terminal**
- **PC-Beep Input**
- **Depop Circuitry**
- **Stereo Input MUX**
- **Fully Differential Input**
- **Low Supply Current and Shutdown Current**
- **Surface-Mount Power Packaging 24-Pin TSSOP PowerPAD™**

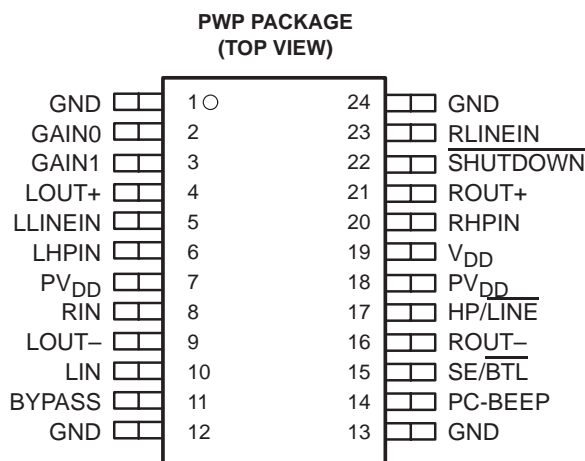

### description

The TPA0212 is a stereo audio power amplifier in a 24-pin TSSOP thermally enhanced package capable of delivering 2 W of continuous RMS power per channel into 3- $\Omega$  loads. This device minimizes the number of external components needed, simplifying the design, and freeing up board space for other features. When driving 1 W into 8- $\Omega$  speakers, the TPA0212 has less than 0.8% THD+N across its specified frequency range.

Included within this device is integrated depop circuitry that virtually eliminates transients that cause noise in the speakers.

Amplifier gain is internally configured and controlled by way of two terminals (GAIN0 and GAIN1). BTL gain settings of 2, 6, 12, and 24 V/V are provided, while SE gain is always configured as 1 V/V for headphone drive. An internal input MUX allows two sets of stereo inputs to the amplifier. The HP/LINE terminal allows the user to select which MUX input is active regardless of whether the amplifier is in SE or BTL mode. In notebook applications, where internal speakers are driven as BTL and the line outputs (often headphone drive) are required to be SE, the TPA0212 automatically switches into SE mode when the SE/BTL input is activated, and this reduces the gain to 1 V/V.

The TPA0212 consumes only 6 mA of supply current during normal operation. A miserly shutdown mode reduces the supply current to less than 150  $\mu$ A.

The PowerPAD package (PWP) delivers a level of thermal performance that was previously achievable only in TO-220-type packages. Thermal impedances of approximately 35°C/W are readily realized in multilayer PCB applications. This allows the TPA0212 to operate at full power into 8- $\Omega$  loads at an ambient temperature of 85°C.



Please be aware that an important notice concerning availability, standard warranty, and use in critical applications of Texas Instruments semiconductor products and disclaimers thereto appears at the end of this data sheet.

PowerPAD is a trademark of Texas Instruments Incorporated.

PRODUCTION DATA information is current as of publication date. Products conform to specifications per the terms of Texas Instruments standard warranty. Production processing does not necessarily include testing of all parameters.



POST OFFICE BOX 655303 • DALLAS, TEXAS 75265

Copyright © 1999, Texas Instruments Incorporated

**TPA0212**  
**STEREO 2-W AUDIO POWER AMPLIFIER**  
**WITH FOUR SELECTABLE GAIN SETTINGS AND MUX CONTROL**

SLOS284 – NOVEMBER 1999

**functional block diagram**

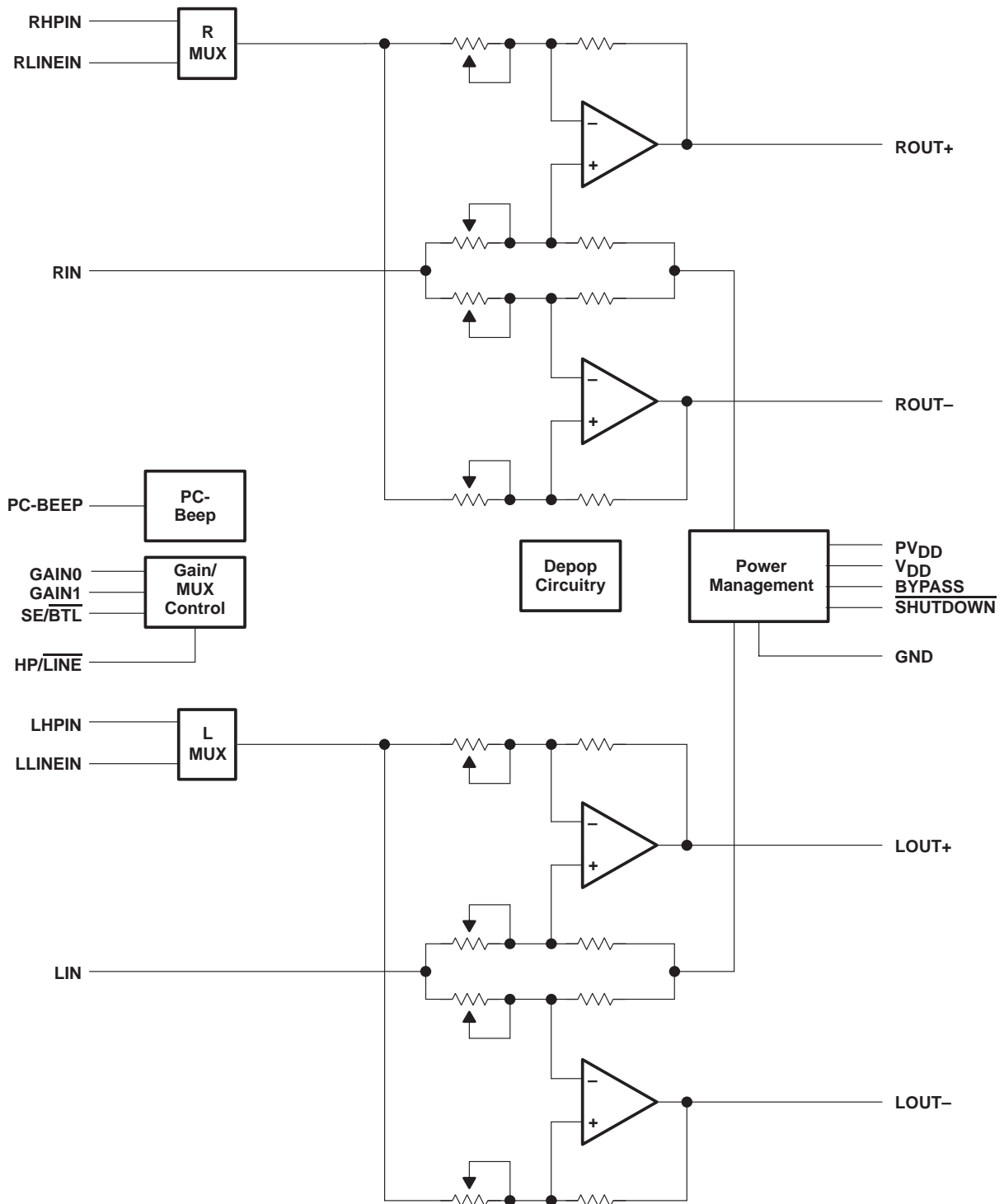

POST OFFICE BOX 655303 • DALLAS, TEXAS 75265

TPA0212  
**STEREO 2-W AUDIO POWER AMPLIFIER**  
**WITH FOUR SELECTABLE GAIN SETTINGS AND MUX CONTROL**  
 SLOS284 – NOVEMBER 1999

AVAILABLE OPTIONS

T <sub>A</sub>	PACKAGED DEVICE
	TSSOP† (PWP)
–40°C to 85°C	TPA0212PWP

† The PWP package is available taped and reeled. To order a taped and reeled part, add the suffix R to the part number (e.g., TPA0212PWPR).

**Terminal Functions**

TERMINAL NAME	NO.	I/O	DESCRIPTION
BYPASS	11		Tap to voltage divider for internal mid-supply bias generator
GAIN0	2	I	Bit 0 of gain control
GAIN1	3	I	Bit 1 of gain control
GND	1, 12, 13, 24		Ground connection for circuitry. Connected to the thermal pad.
LHPIN	6	I	Left channel headphone input, selected when SE/BTL is held high
LIN	10	I	Common left input for fully differential input. AC ground for single-ended inputs.
LLINEIN	5	I	Left channel line input, selected when SE/BTL is held low
LOUT+	4	O	Left channel positive output in BTL mode and positive output in SE mode
LOUT–	9	O	Left channel negative output in BTL mode and high-impedance in SE mode
PC-BEEP	14	I	The input for PC Beep mode. PC-BEEP is enabled when a > 1-V (peak-to-peak) square wave is input to PC-BEEP or PCB ENABLE is high.
HP/LINE	17	I	HP/LINE is the input MUX control input. When the HP/LINE terminal is held high, the headphone inputs (LHPIN or RHPIN [6, 20]) are active. When the HP/LINE terminal is held low, the line BTL inputs (LLINEIN or RLINEIN [5, 23]) are active.
PVDD	7, 18	I	Power supply for output stage
RHPIN	20	I	Right channel headphone input, selected when SE/BTL is held high
RIN	8	I	Common right input for fully differential input. AC ground for single-ended inputs.
RLINEIN	23	I	Right channel line input, selected when SE/BTL is held low
ROUT+	21	O	Right channel positive output in BTL mode and positive output in SE mode
ROUT–	16	O	Right channel negative output in BTL mode and high-impedance in SE mode
SHUTDOWN	22	I	Places entire IC in shutdown mode when held low, except PC-BEEP remains active
SE/BTL	15	I	Hold SE/BTL low for BTL mode and hold high for SE mode.
VDD	19	I	Analog VDD input supply. This terminal needs to be isolated from PVDD to achieve highest performance.



**TPA0212**  
**STEREO 2-W AUDIO POWER AMPLIFIER**  
**WITH FOUR SELECTABLE GAIN SETTINGS AND MUX CONTROL**

SLOS284 – NOVEMBER 1999

**absolute maximum ratings over operating free-air temperature range (unless otherwise noted)†**

Supply voltage, $V_{DD}$	6 V
Input voltage, $V_I$	-0.3 V to $V_{DD} + 0.3$ V
Continuous total power dissipation	internally limited (see Dissipation Rating Table)
Operating free-air temperature range, $T_A$	-40°C to 85°C
Operating junction temperature range, $T_J$	-40°C to 150°C
Storage temperature range, $T_{stg}$	-65°C to 150°C
Lead temperature 1,6 mm (1/16 inch) from case for 10 seconds	260°C

† Stresses beyond those listed under “absolute maximum ratings” may cause permanent damage to the device. These are stress ratings only, and functional operation of the device at these or any other conditions beyond those indicated under “recommended operating conditions” is not implied. Exposure to absolute-maximum-rated conditions for extended periods may affect device reliability.

**DISSIPATION RATING TABLE**

PACKAGE	$T_A \leq 25^\circ\text{C}$	DERATING FACTOR	$T_A = 70^\circ\text{C}$	$T_A = 85^\circ\text{C}$
PWP	2.7 W‡	21.8 mW/°C	1.7 W	1.4 W

‡ Please see the Texas Instruments document, *PowerPAD Thermally Enhanced Package Application Report* (literature number SLMA002), for more information on the PowerPAD package. The thermal data was measured on a PCB layout based on the information in the section entitled *Texas Instruments Recommended Board for PowerPAD* on page 33 of the before mentioned document.

**recommended operating conditions**

	MIN	MAX	UNIT
Supply voltage, $V_{DD}$	4.5	5.5	V
High-level input voltage, $V_{IH}$	SE/BTL, HP/LINE	4	V
	SHUTDOWN	2	
Low-level input voltage, $V_{IL}$	SE/BTL, HP/LINE	3	V
	SHUTDOWN	0.8	
Operating free-air temperature, $T_A$	-40	85	°C

**electrical characteristics at specified free-air temperature,  $V_{DD} = 5$  V,  $T_A = 25^\circ\text{C}$  (unless otherwise noted)**

PARAMETER	TEST CONDITIONS	MIN	TYP	MAX	UNIT
$ V_{OO} $ Output offset voltage (measured differentially)	$V_I = 0$ , $A_V = -2$ V/V			25	mV
PSRR Power supply rejection ratio	$V_{DD} = 4$ V to 5 V		77		dB
$ I_{IH} $ High-level input current	$V_{DD} = 5.5$ V, $V_I = V_{DD}$			900	nA
$ I_{IL} $ Low-level input current	$V_{DD} = 5.5$ V, $V_I = 0$ V			900	nA
$I_{DD}$ Supply current	BTL mode		6	8	mA
	SE mode		3	4	
$I_{DD(SD)}$ Supply current, shutdown mode			150	300	µA



**TPA0212**  
**STEREO 2-W AUDIO POWER AMPLIFIER**  
**WITH FOUR SELECTABLE GAIN SETTINGS AND MUX CONTROL**  
SLOS284 – NOVEMBER 1999

**operating characteristics,  $V_{DD} = 5\text{ V}$ ,  $T_A = 25^\circ\text{C}$ ,  $R_L = 8\ \Omega$ , Gain =  $-2\text{ V/V}$ , BTL mode**

PARAMETER		TEST CONDITIONS		MIN	TYP	MAX	UNIT
$P_O$	Output power	THD = 1%, $R_L = 4\ \Omega$	$f = 1\text{ kHz}$ ,		1.9		W
THD + N	Total harmonic distortion plus noise	$P_O = 1\text{ W}$ ,	$f = 20\text{ Hz to }15\text{ kHz}$		0.75%		
$B_{OM}$	Maximum output power bandwidth	THD = 5%			>15		kHz
	Supply ripple rejection ratio	$f = 1\text{ kHz}$ , $C_B = 0.47\ \mu\text{F}$	BTL mode		68		dB
SNR	Signal-to-noise ratio				105		dB
$V_n$	Noise output voltage	$C_B = 0.47\ \mu\text{F}$ , $f = 20\text{ Hz to }20\text{ kHz}$	BTL mode		16		$\mu\text{V}_{RMS}$
			SE mode		30		
$Z_I$	Input impedance				See Table 1		

### TYPICAL CHARACTERISTICS

Table of Graphs

				FIGURE
THD+N	Total harmonic distortion plus noise	vs Output power		1, 4–7, 10–13, 16–19, 21
		vs Frequency		2, 3, 8, 9, 14, 15, 20, 22
		vs Output voltage		23
$V_n$	Output noise voltage	vs Bandwidth		24
	Supply ripple rejection ratio	vs Frequency		25, 26
	Crosstalk	vs Frequency		27–29
	Shutdown attenuation	vs Frequency		30
SNR	Signal-to-noise ratio	vs Frequency		31
	Closed loop response			32–35
$P_O$	Output power	vs Load resistance		36, 37
$P_D$	Power dissipation	vs Output power		38, 39
		vs Ambient temperature		40



TYPICAL CHARACTERISTICS

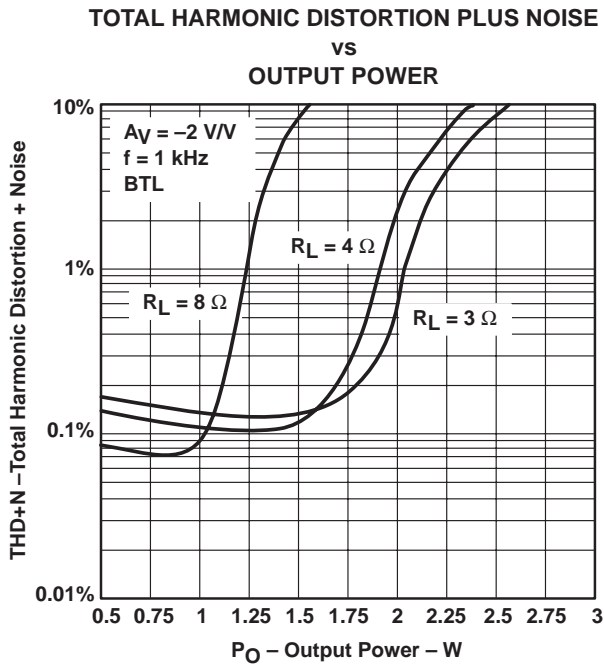

Figure 1

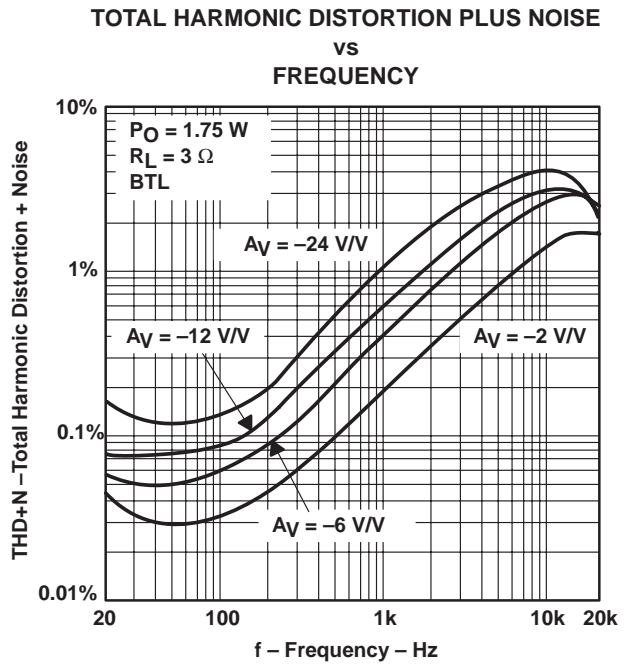

Figure 2

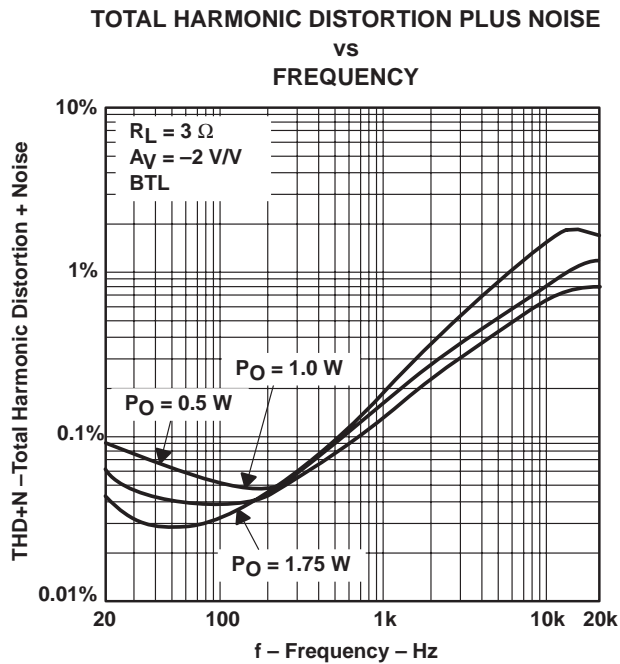

Figure 3

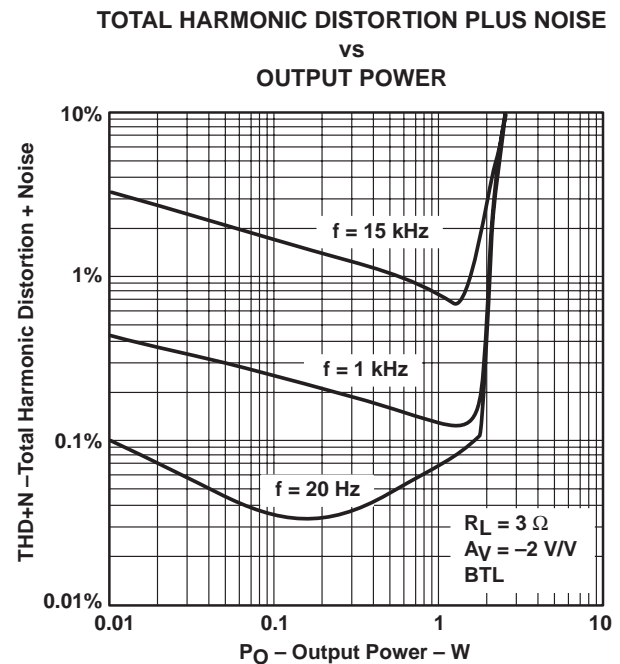
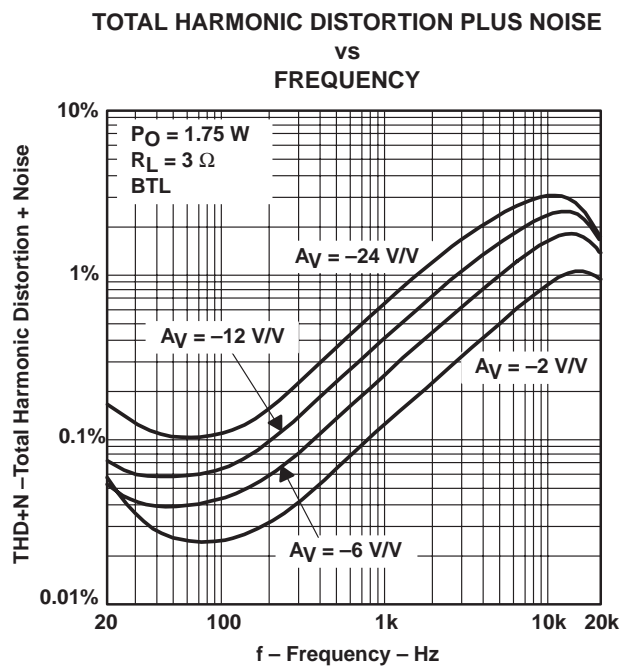
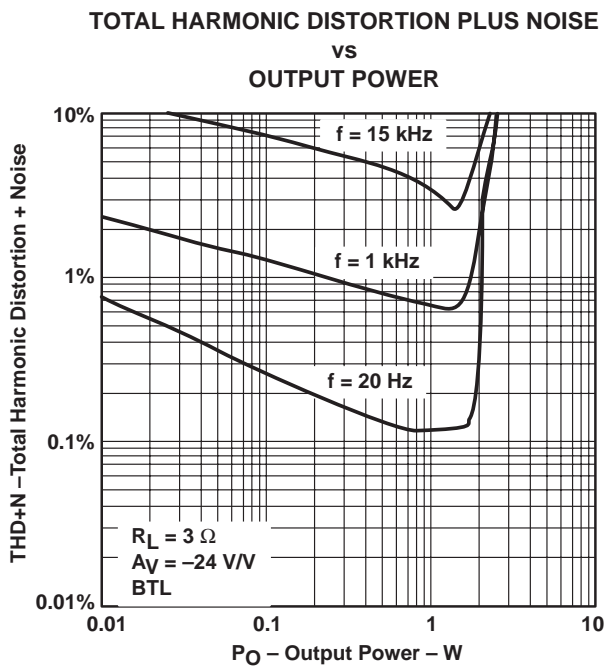
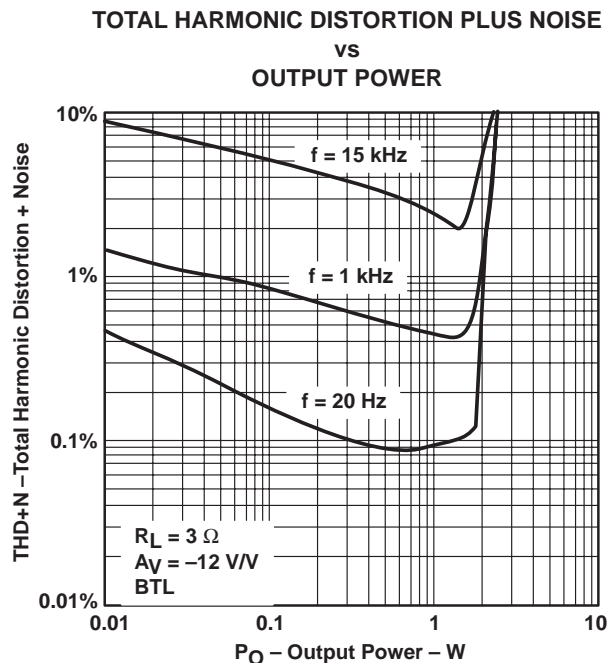
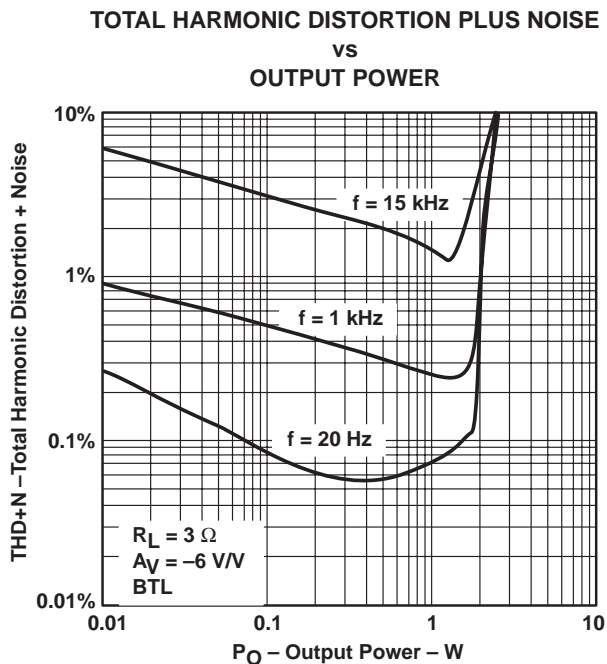

Figure 4

**TYPICAL CHARACTERISTICS**



TYPICAL CHARACTERISTICS

TOTAL HARMONIC DISTORTION PLUS NOISE  
 vs  
 FREQUENCY

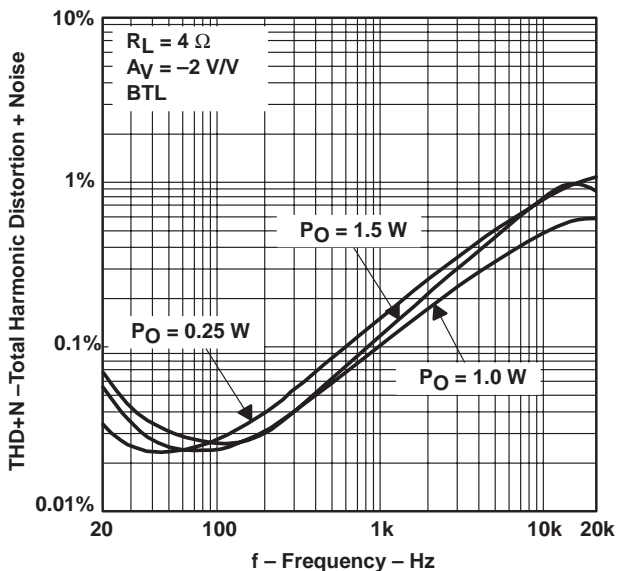

Figure 9

TOTAL HARMONIC DISTORTION PLUS NOISE  
 vs  
 OUTPUT POWER

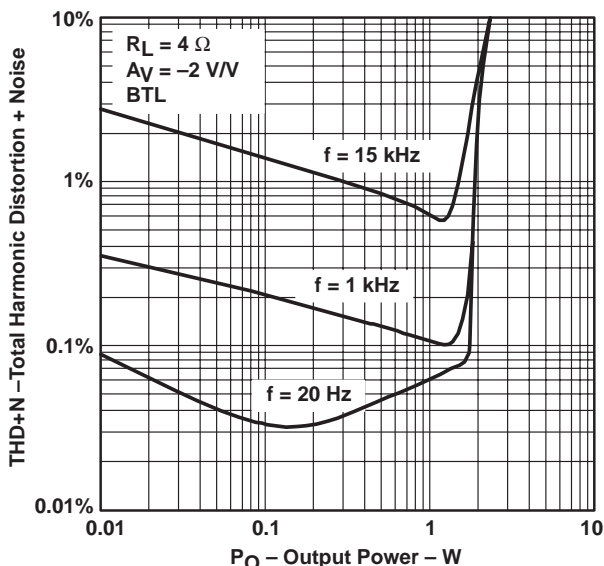

Figure 10

TOTAL HARMONIC DISTORTION PLUS NOISE  
 vs  
 OUTPUT POWER

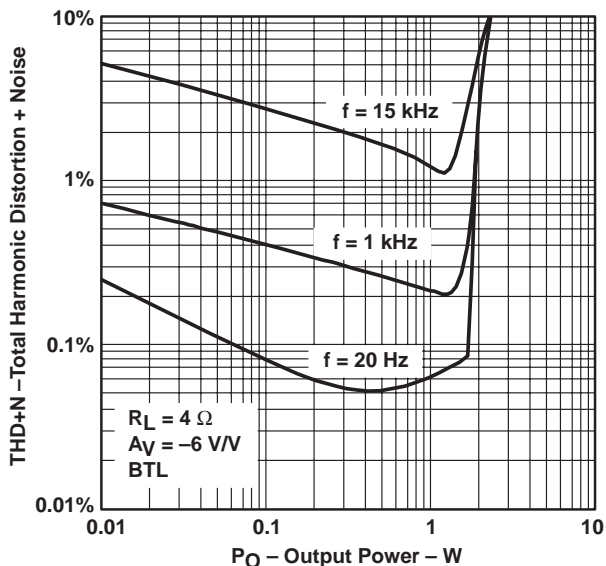

Figure 11

TOTAL HARMONIC DISTORTION PLUS NOISE  
 vs  
 OUTPUT POWER

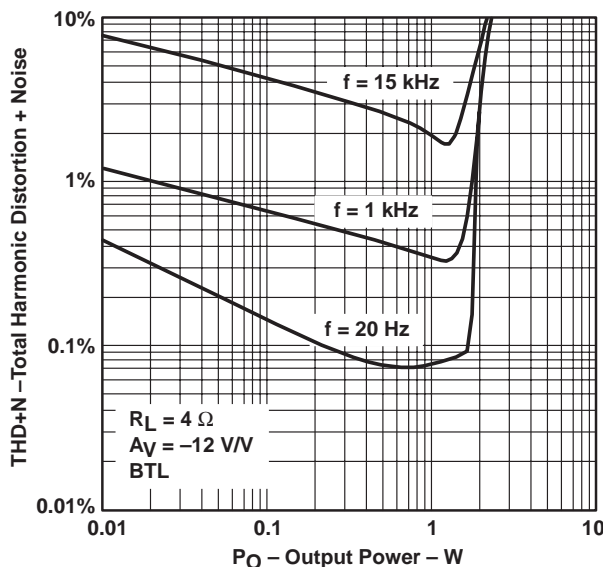

Figure 12



**TYPICAL CHARACTERISTICS**

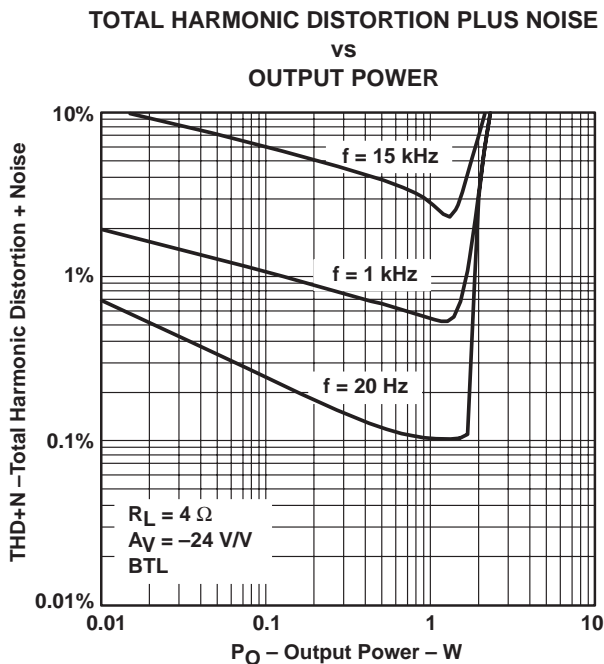

Figure 13

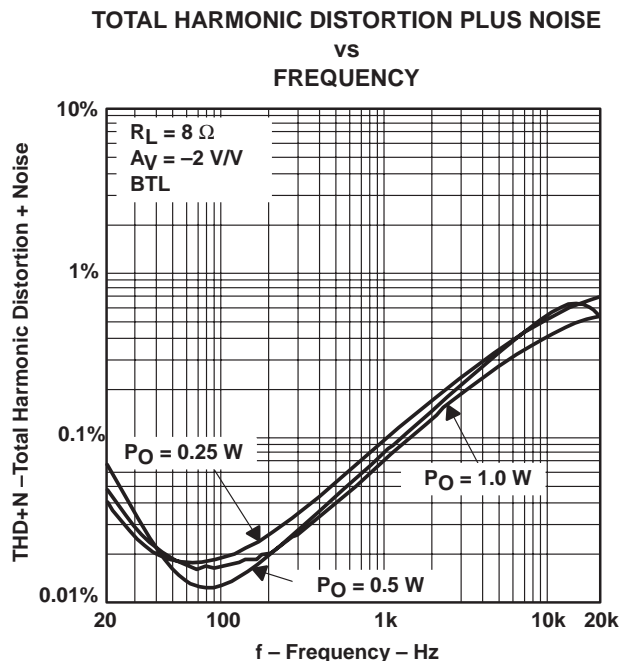

Figure 14

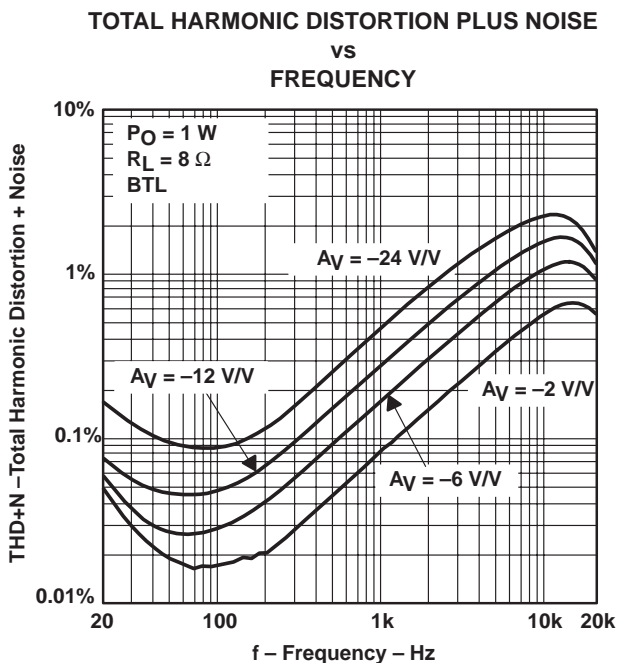

Figure 15

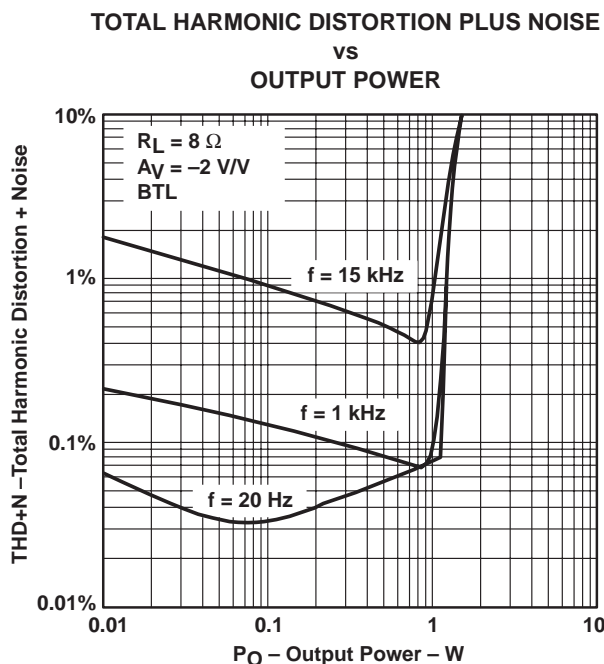

Figure 16

TYPICAL CHARACTERISTICS

TOTAL HARMONIC DISTORTION PLUS NOISE  
 vs  
 OUTPUT POWER

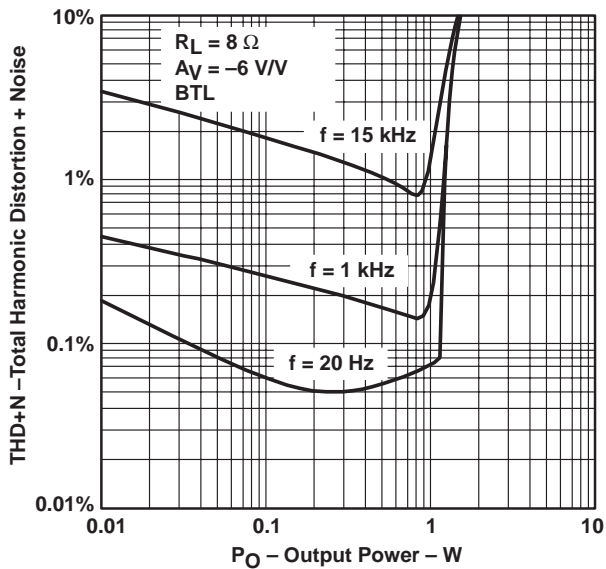

Figure 17

TOTAL HARMONIC DISTORTION PLUS NOISE  
 vs  
 OUTPUT POWER

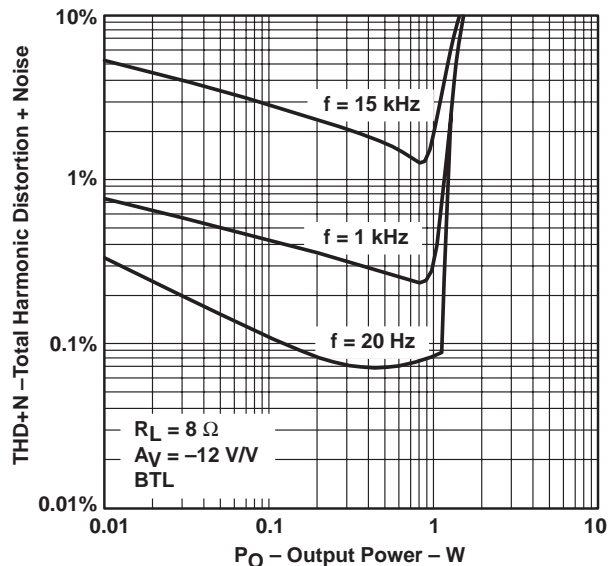

Figure 18

TOTAL HARMONIC DISTORTION PLUS NOISE  
 vs  
 OUTPUT POWER

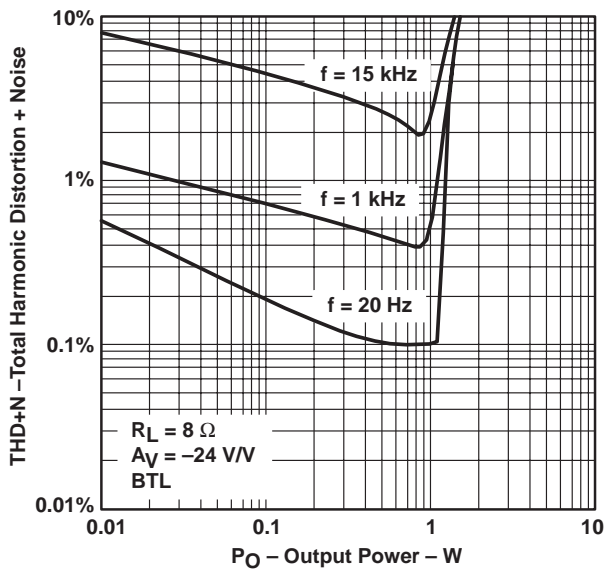

Figure 19

TOTAL HARMONIC DISTORTION PLUS NOISE  
 vs  
 FREQUENCY

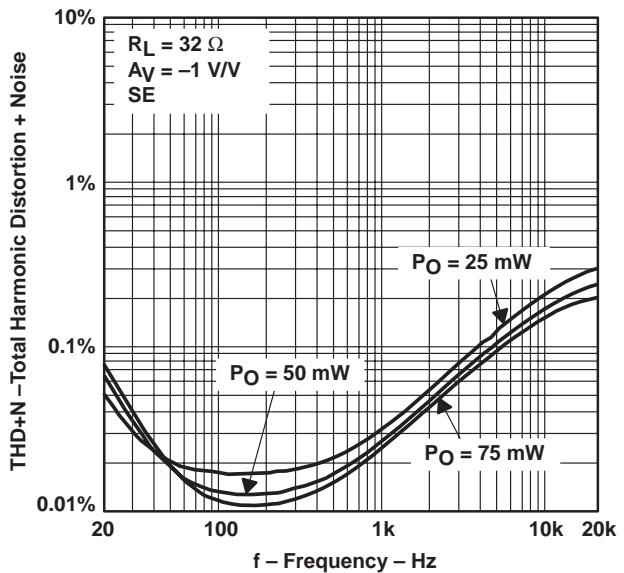

Figure 20

**TYPICAL CHARACTERISTICS**

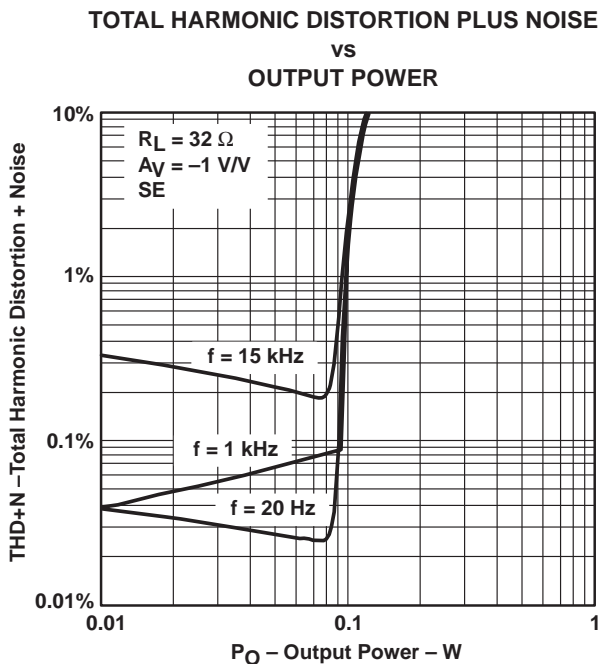

Figure 21

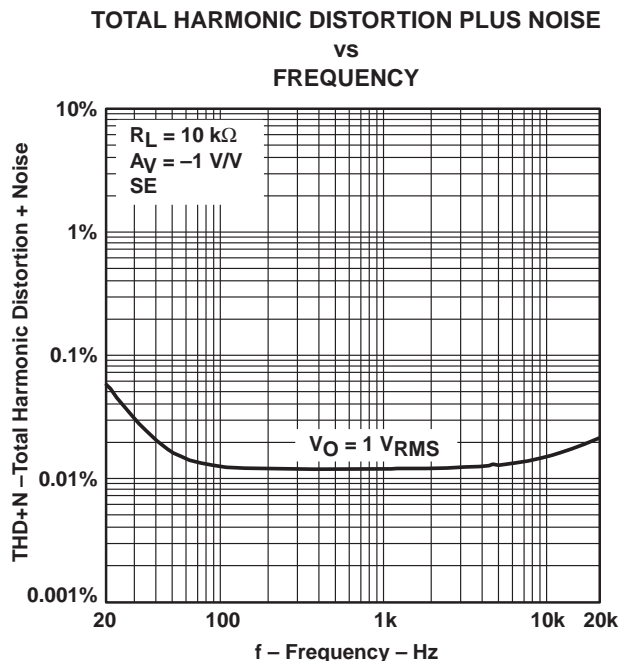

Figure 22

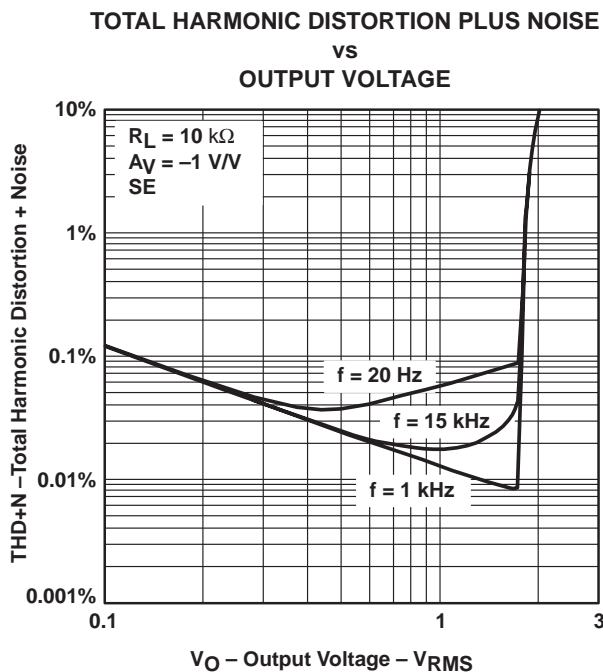

Figure 23

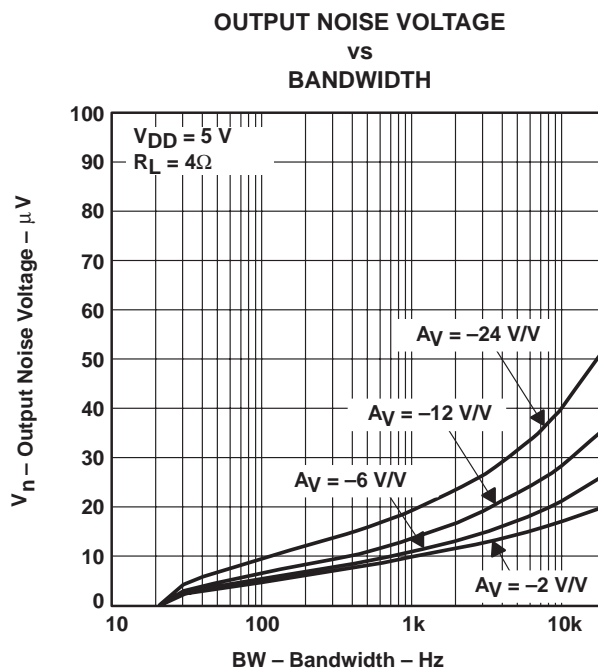
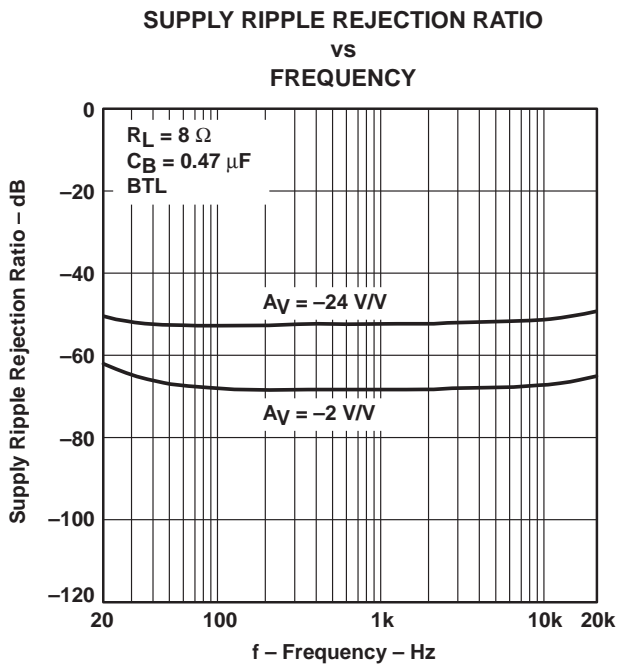

Figure 24

**TPA0212**  
**STEREO 2-W AUDIO POWER AMPLIFIER**  
**WITH FOUR SELECTABLE GAIN SETTINGS AND MUX CONTROL**  
 SLOS284 – NOVEMBER 1999

**TYPICAL CHARACTERISTICS**



**Figure 25**

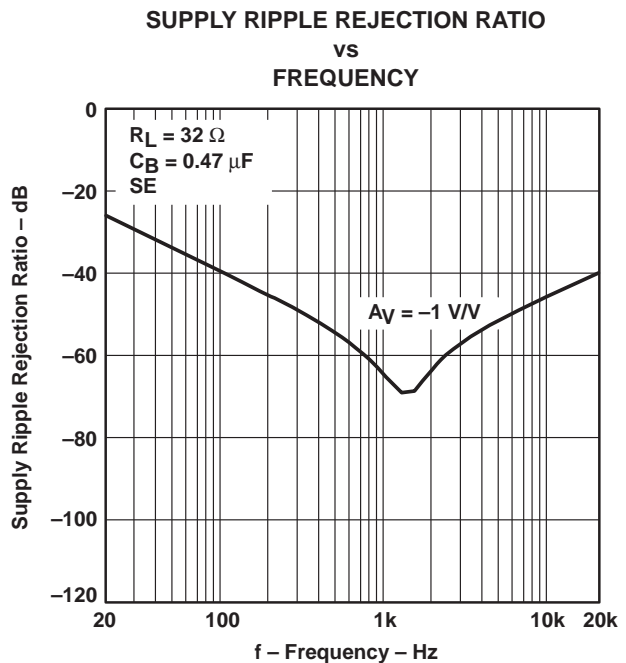

**Figure 26**

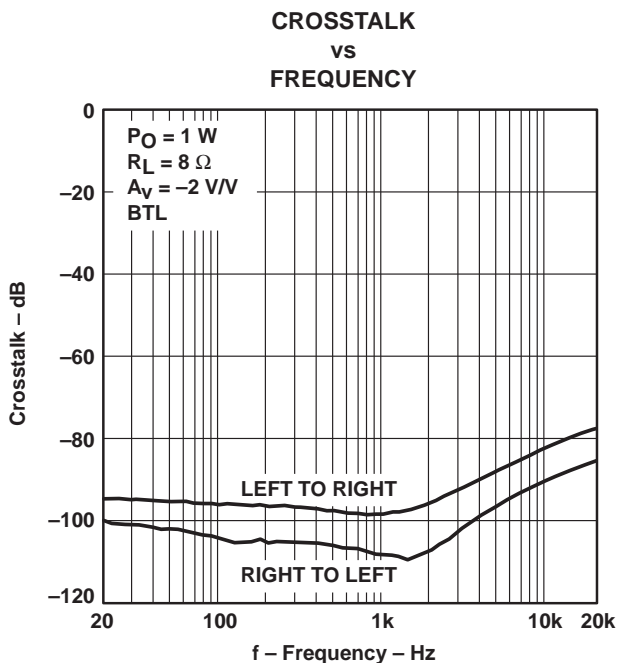

**Figure 27**

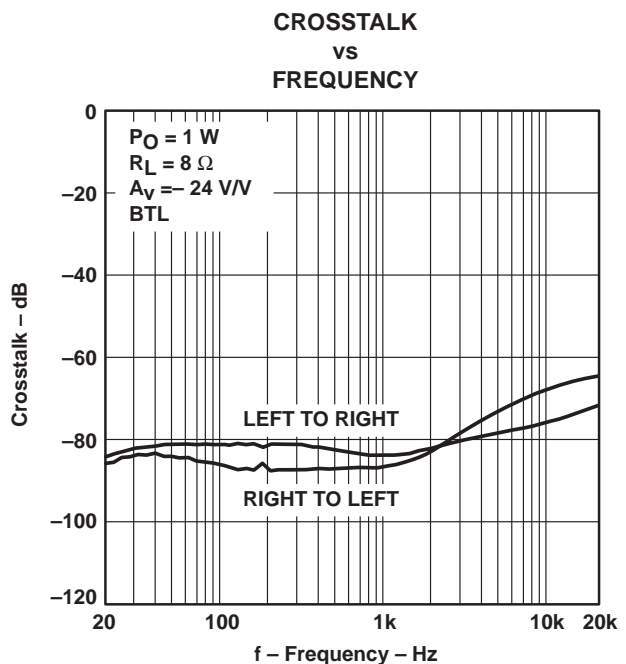

**Figure 28**



**TYPICAL CHARACTERISTICS**

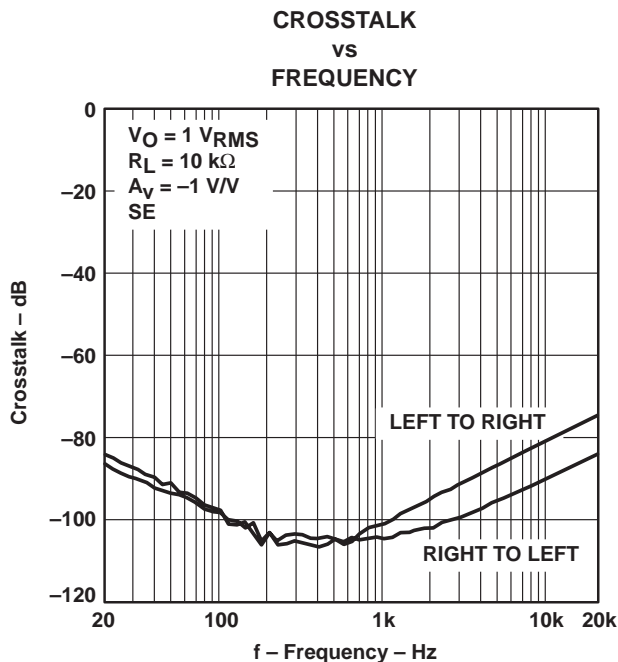

Figure 29

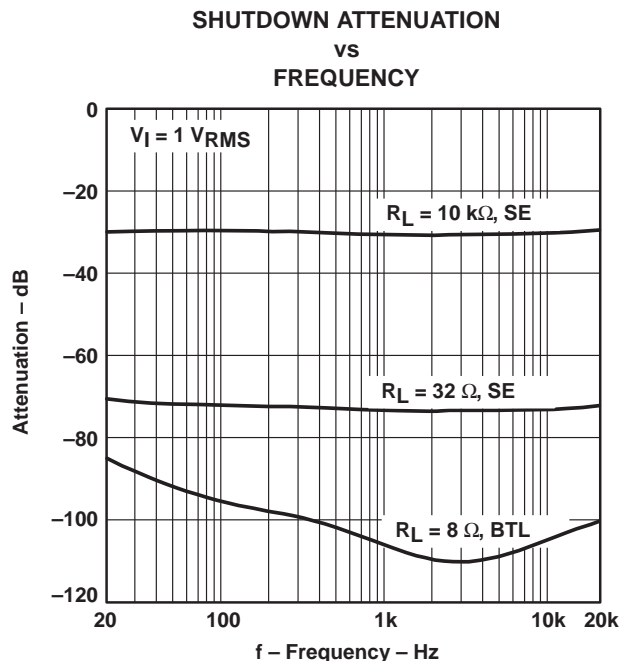

Figure 30

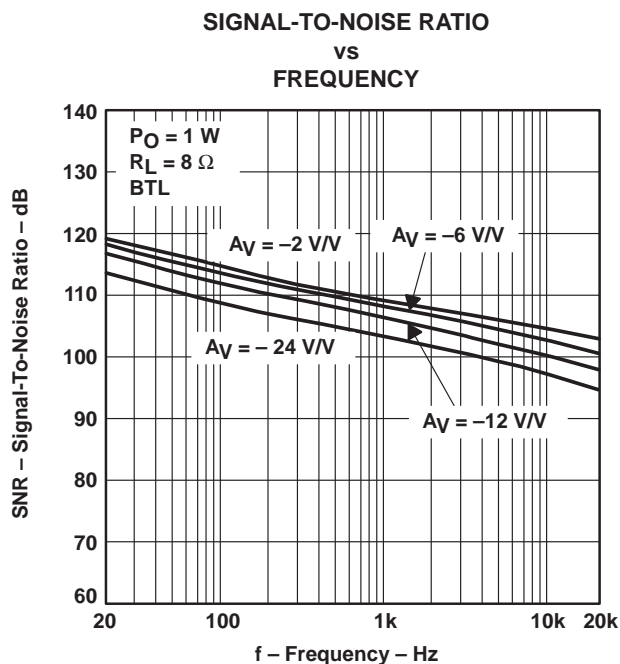

Figure 31

TYPICAL CHARACTERISTICS

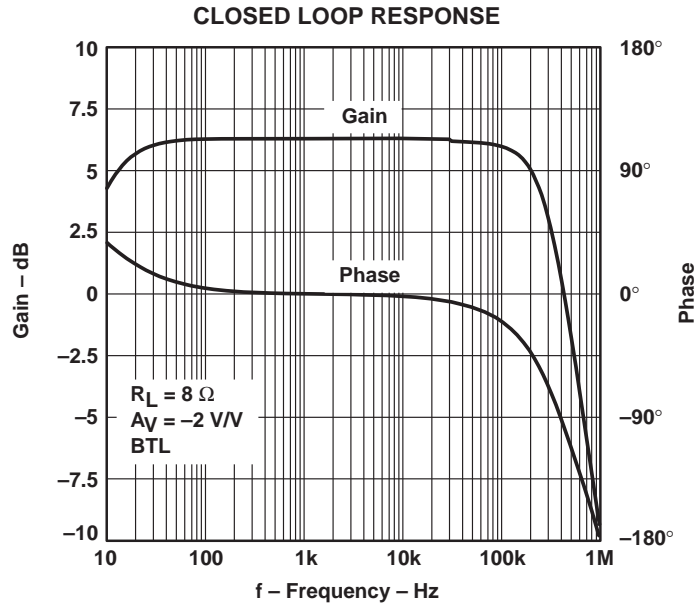

Figure 32

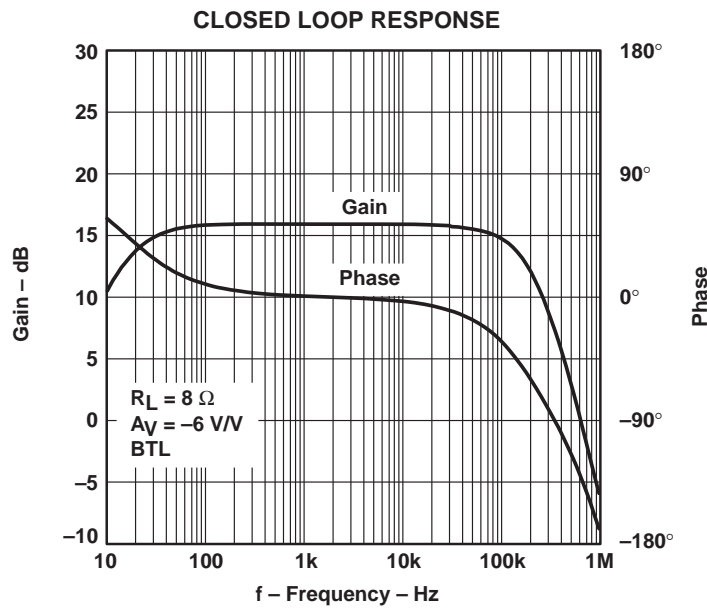

Figure 33

**TYPICAL CHARACTERISTICS**

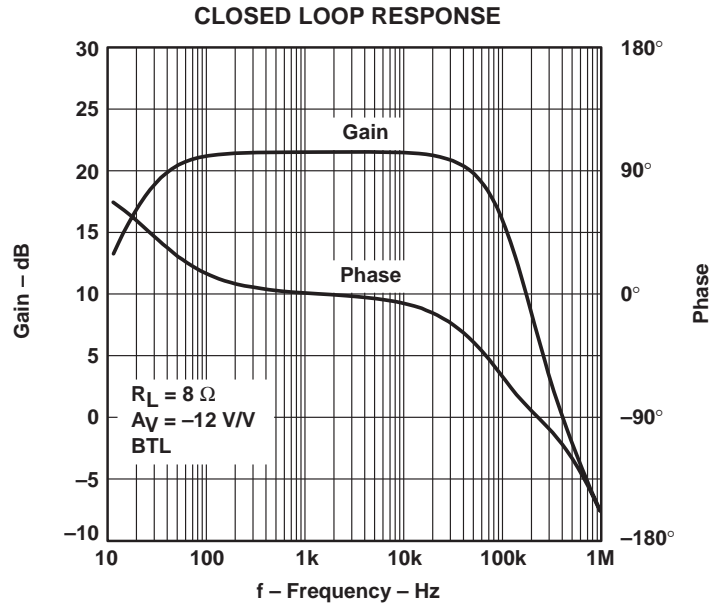

Figure 34

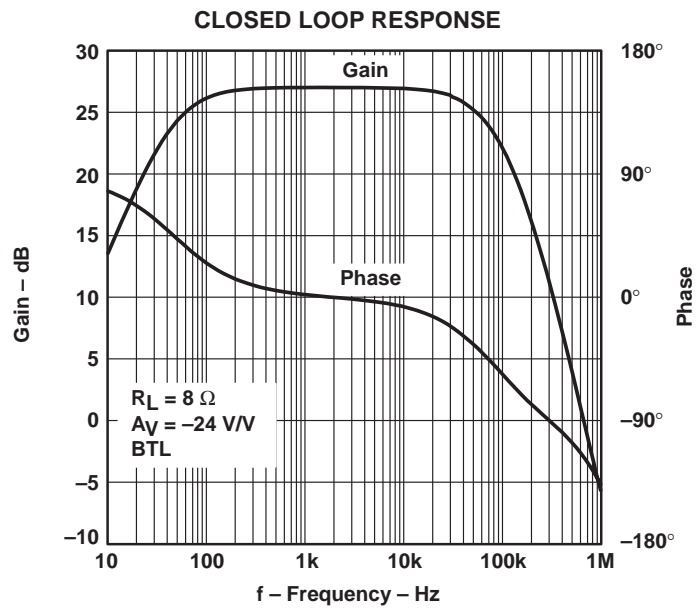

Figure 35

TYPICAL CHARACTERISTICS

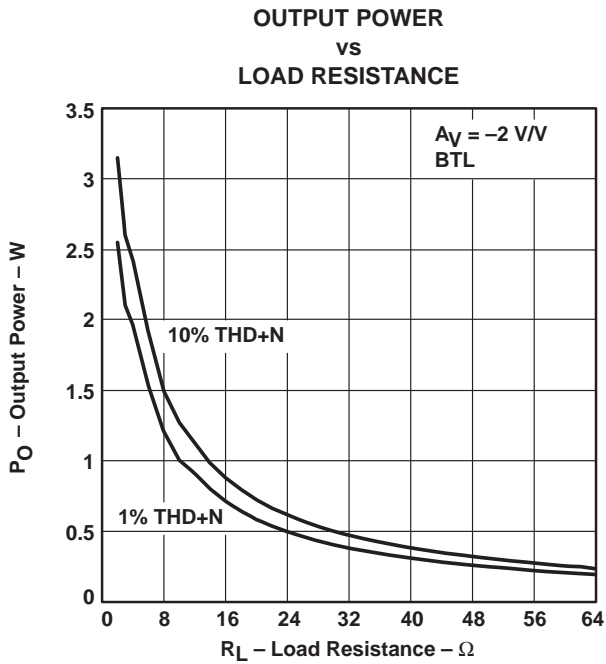

Figure 36

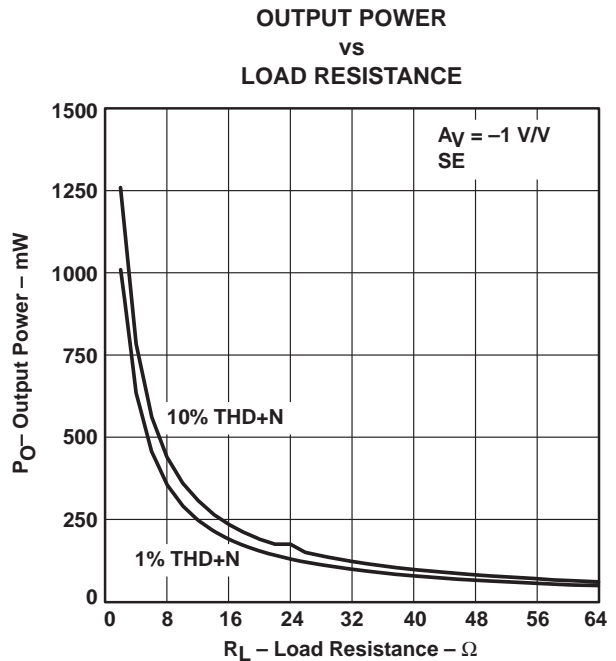

Figure 37

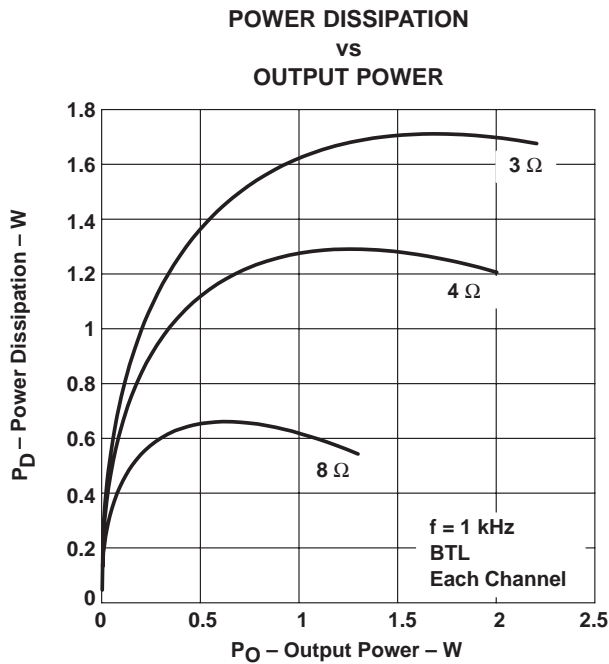

Figure 38

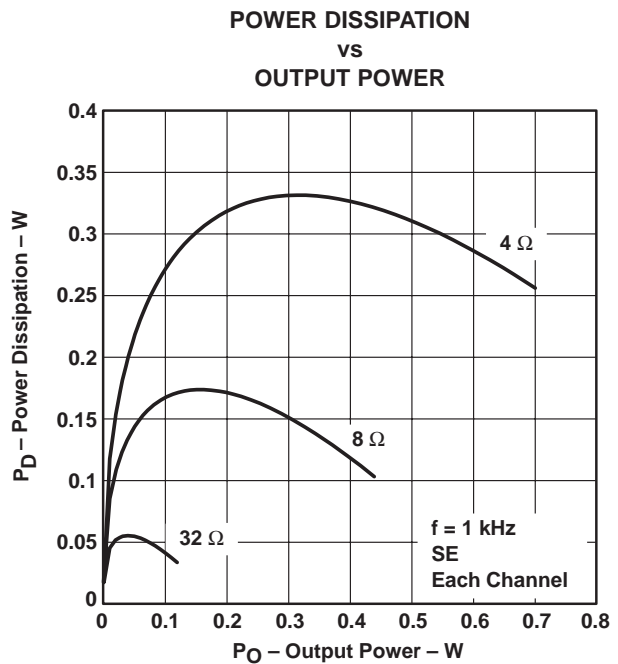

Figure 39



TYPICAL CHARACTERISTICS

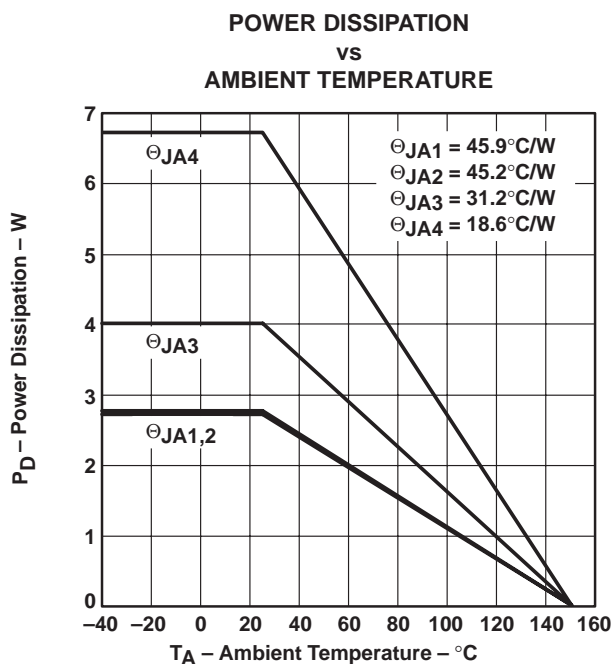

Figure 40

**TPA0212**  
**STEREO 2-W AUDIO POWER AMPLIFIER**  
**WITH FOUR SELECTABLE GAIN SETTINGS AND MUX CONTROL**  
SLOS284 – NOVEMBER 1999

---

**THERMAL INFORMATION**

The thermally enhanced PWP package is based on the 24-pin TSSOP, but includes a thermal pad (see Figure 41) to provide an effective thermal contact between the IC and the PWB.

Traditionally, surface mount and power have been mutually exclusive terms. A variety of scaled-down TO-220-type packages have leads formed as gull wings to make them applicable for surface-mount applications. These packages, however, have only two shortcomings: they do not address the very low profile requirements (<2 mm) of many of today's advanced systems, and they do not offer a terminal-count high enough to accommodate increasing integration. On the other hand, traditional low-power surface-mount packages require power-dissipation derating that severely limits the usable range of many high-performance analog circuits.

The PowerPAD package (thermally enhanced TSSOP) combines fine-pitch surface-mount technology with thermal performance comparable to much larger power packages.

The PowerPAD package is designed to optimize the heat transfer to the PWB. Because of the very small size and limited mass of a TSSOP package, thermal enhancement is achieved by improving the thermal conduction paths that remove heat from the component. The thermal pad is formed using a patented lead-frame design and manufacturing technique to provide a direct connection to the heat-generating IC. When this pad is soldered or otherwise thermally coupled to an external heat dissipator, high power dissipation in the ultra-thin, fine-pitch, surface-mount package can be reliably achieved.

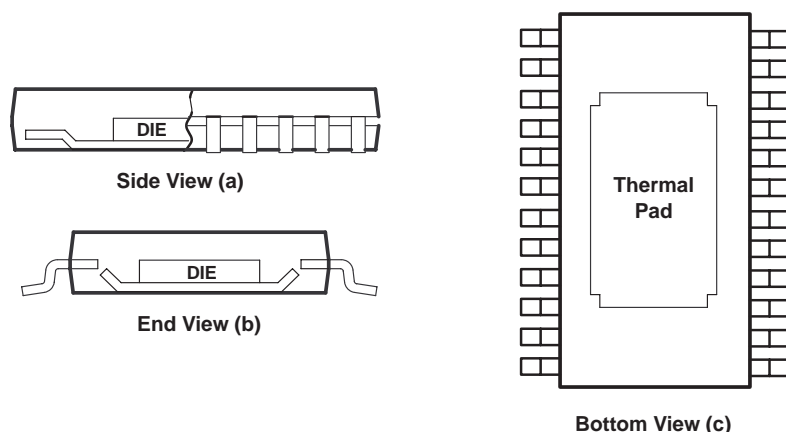

**Figure 41. Views of Thermally Enhanced PWP Package**

---

**APPLICATION INFORMATION**

**selection of components**

Figure 42 and Figure 43 are schematic diagrams of typical notebook computer application circuits.

TPA0212  
**STEREO 2-W AUDIO POWER AMPLIFIER**  
**WITH FOUR SELECTABLE GAIN SETTINGS AND MUX CONTROL**  
 SLOS284 – NOVEMBER 1999

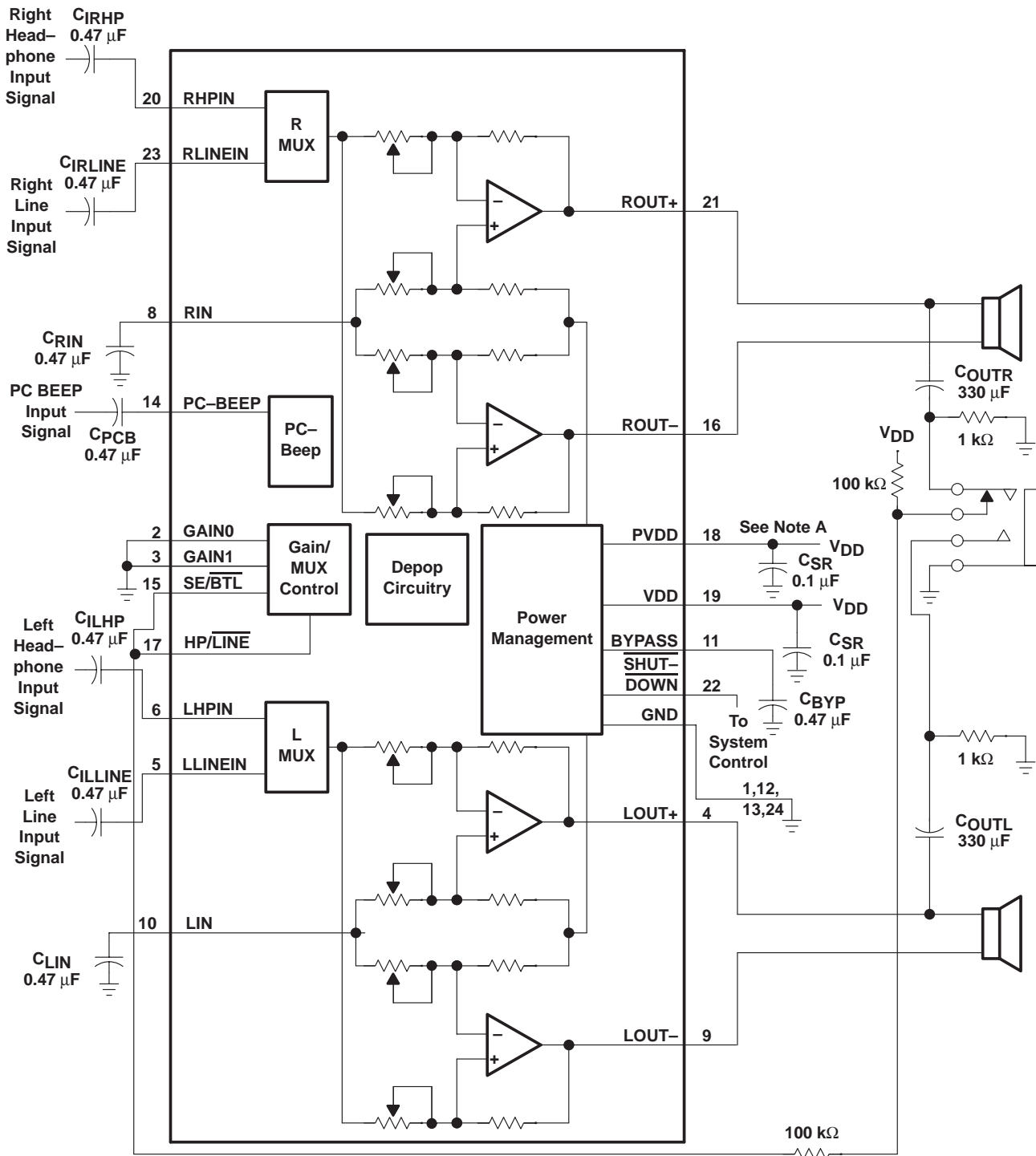

NOTE A: A 0.1  $\mu\text{F}$  ceramic capacitor should be placed as close as possible to the IC. For filtering lower-frequency noise signals, a larger electrolytic capacitor of 10  $\mu\text{F}$  or greater should be placed near the audio power amplifier.

**Figure 42. Typical TPA0212 Application Circuit Using Single-Ended Inputs and Input MUX**

**TPA0212**  
**STEREO 2-W AUDIO POWER AMPLIFIER**  
**WITH FOUR SELECTABLE GAIN SETTINGS AND MUX CONTROL**  
 SLOS284 – NOVEMBER 1999

**APPLICATION INFORMATION**

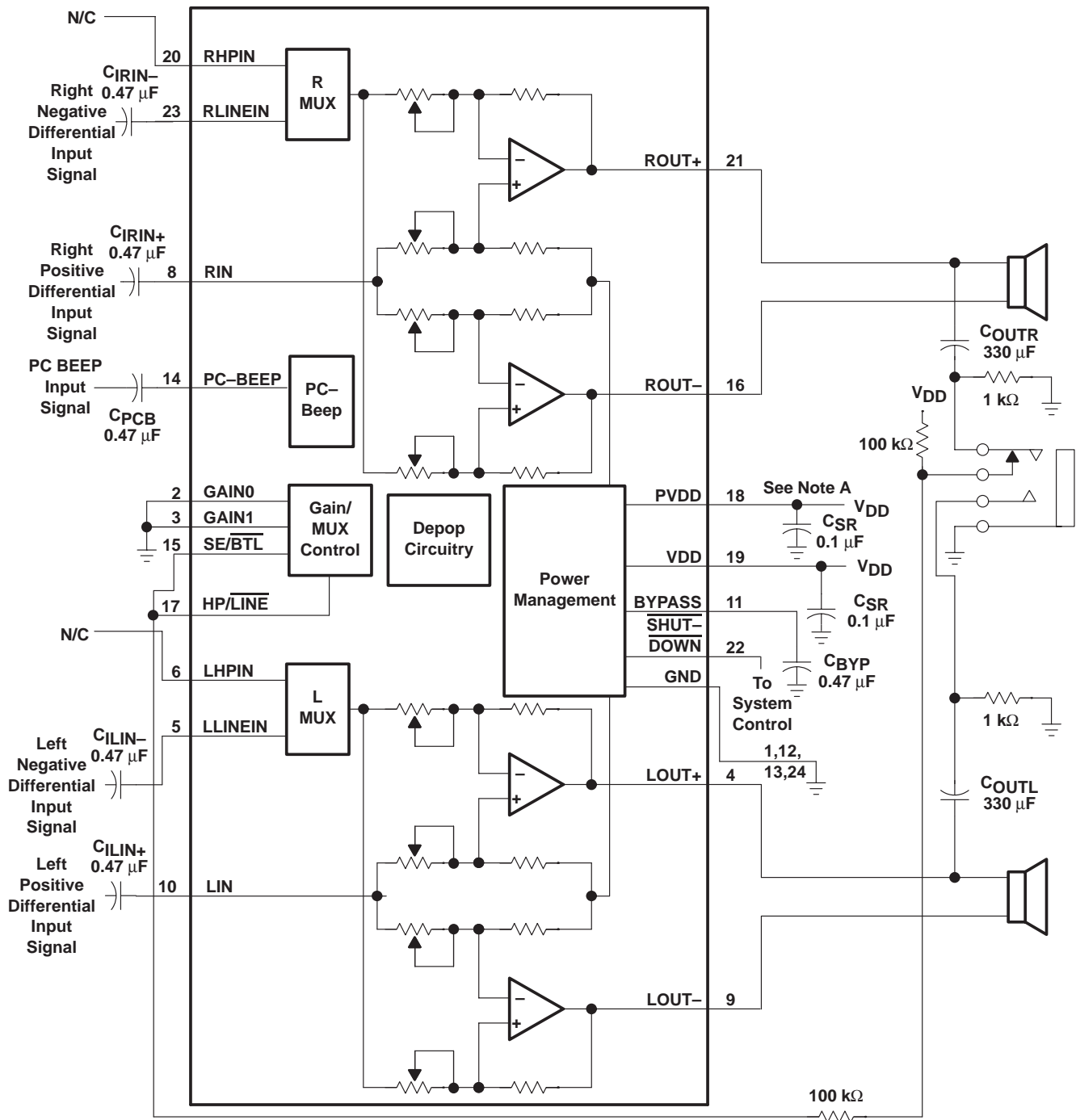

NOTE A: A 0.1 μF ceramic capacitor should be placed as close as possible to the IC. For filtering lower-frequency noise signals, a larger electrolytic capacitor of 10 μF or greater should be placed near the audio power amplifier.

**Figure 43. Typical TPA0212 Application Circuit Using Differential Inputs**



### APPLICATION INFORMATION

#### gain setting via GAIN0 and GAIN1 inputs

The gain of the TPA0212 is set by two input terminals, GAIN0 and GAIN1.

**Table 1. Gain Settings**

GAIN0	GAIN1	SE/BTL	$A_v$
0	0	0	-2 V/V
0	1	0	-6 V/V
1	0	0	-12 V/V
1	1	0	-24 V/V
X	X	1	-1 V/V

The gains listed in Table 1 are realized by changing the taps on the input resistors inside the amplifier. This causes the input impedance,  $Z_I$ , to be dependant on the gain setting. The actual gain settings are controlled by ratios of resistors, so the actual gain distribution from part-to-part is quite good. However, the input impedance will shift by 30% due to shifts in the actual resistance of the input impedance.

For design purposes, the input network (discussed in the next section) should be designed assuming an input impedance of 10 k $\Omega$ , which is the absolute minimum input impedance of the TPA0212. At the higher gain settings, the input impedance could increase as high as 115 k $\Omega$ .

#### input resistance

Each gain setting is achieved by varying the input resistance of the amplifier, which can range from its smallest value to over 6 times that value. As a result, if a single capacitor is used in the input high pass filter, the -3 dB or cut-off frequency will also change by over 6 times. If an additional resistor is connected from the input pin of the amplifier to ground, as shown in the figure below, the variation of the cut-off frequency will be much reduced.

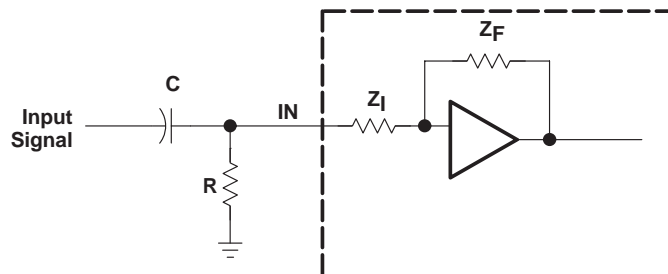

The typical input impedance at each gain setting is given in the table below:

$A_v$	$Z_I$
-24 V/V	14 k $\Omega$
-12 V/V	26 k $\Omega$
-6 V/V	45.5 k $\Omega$
-2 V/V	91 k $\Omega$

**TPA0212**  
**STEREO 2-W AUDIO POWER AMPLIFIER**  
**WITH FOUR SELECTABLE GAIN SETTINGS AND MUX CONTROL**  
 SLOS284 – NOVEMBER 1999

**APPLICATION INFORMATION**

The -3 dB frequency can be calculated using equation 1:

$$f_{-3\text{ dB}} = \frac{1}{2\pi C(R \parallel R_I)} \tag{1}$$

If the filter must be more accurate, the value of the capacitor should be increased while the value of the resistor to ground should be decreased. In addition, the order of the filter could be increased.

**input capacitor, C<sub>I</sub>**

In the typical application an input capacitor, C<sub>I</sub>, is required to allow the amplifier to bias the input signal to the proper dc level for optimum operation. In this case, C<sub>I</sub> and the input impedance of the amplifier, Z<sub>I</sub>, form a high-pass filter with the corner frequency determined in equation 2.

$$f_{c(\text{highpass})} = \frac{1}{2\pi Z_I C_I} \tag{2}$$

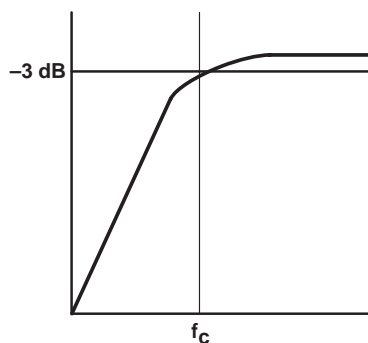

The value of C<sub>I</sub> is important to consider as it directly affects the bass (low frequency) performance of the circuit. Consider the example where Z<sub>I</sub> is 710 kΩ and the specification calls for a flat bass response down to 40 Hz. Equation 2 is reconfigured as equation 3.

$$C_I = \frac{1}{2\pi Z_I f_c} \tag{3}$$

In this example, C<sub>I</sub> is 5.6 nF so one would likely choose a value in the range of 5.6 nF to 1 μF. A further consideration for this capacitor is the leakage path from the input source through the input network (C<sub>I</sub>) and the feedback network to the load. This leakage current creates a dc offset voltage at the input to the amplifier that reduces useful headroom, especially in high gain applications. For this reason a low-leakage tantalum or ceramic capacitor is the best choice. When polarized capacitors are used, the positive side of the capacitor should face the amplifier input in most applications as the dc level there is held at V<sub>DD</sub>/2, which is likely higher than the source dc level. Note that it is important to confirm the capacitor polarity in the application.



## APPLICATION INFORMATION

### power supply decoupling, $C_S$

The TPA0212 is a high-performance CMOS audio amplifier that requires adequate power supply decoupling to ensure the output total harmonic distortion (THD) is as low as possible. Power supply decoupling also prevents oscillations for long lead lengths between the amplifier and the speaker. The optimum decoupling is achieved by using two capacitors of different types that target different types of noise on the power supply leads. For higher frequency transients, spikes, or digital hash on the line, a good low equivalent-series-resistance (ESR) ceramic capacitor, typically 0.1  $\mu\text{F}$  placed as close as possible to the device  $V_{DD}$  lead, works best. For filtering lower-frequency noise signals, a larger aluminum electrolytic capacitor of 10  $\mu\text{F}$  or greater placed near the audio power amplifier is recommended.

### midrail bypass capacitor, $C_{BYP}$

The midrail bypass capacitor,  $C_{BYP}$ , is the most critical capacitor and serves several important functions. During start-up or recovery from shutdown mode,  $C_{BYP}$  determines the rate at which the amplifier starts up. The second function is to reduce noise produced by the power supply caused by coupling into the output drive signal. This noise is from the midrail generation circuit internal to the amplifier, which appears as degraded PSRR and THD+N.

Bypass capacitor,  $C_{BYP}$ , values of 0.47  $\mu\text{F}$  to 1  $\mu\text{F}$  ceramic or tantalum low-ESR capacitors are recommended for the best THD and noise performance.

### output coupling capacitor, $C_C$

In the typical single-supply SE configuration, an output coupling capacitor ( $C_C$ ) is required to block the dc bias at the output of the amplifier thus preventing dc currents in the load. As with the input coupling capacitor, the output coupling capacitor and impedance of the load form a high-pass filter governed by equation 4.

$$f_{c(\text{high})} = \frac{1}{2\pi R_L C_C}$$

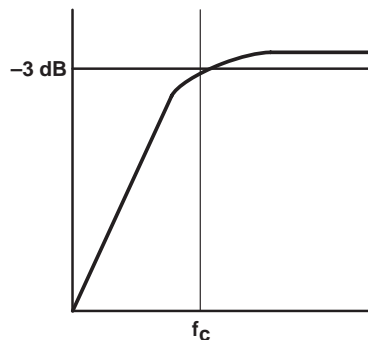

(4)

The main disadvantage, from a performance standpoint, is the load impedances are typically small, which drives the low-frequency corner higher, degrading the bass response. Large values of  $C_C$  are required to pass low frequencies into the load. Consider the example where a  $C_C$  of 330  $\mu\text{F}$  is chosen and loads vary from 3  $\Omega$ , 4  $\Omega$ , 8  $\Omega$ , 32  $\Omega$ , 10 k $\Omega$ , to 47 k $\Omega$ . Table 2 summarizes the frequency response characteristics of each configuration.

**APPLICATION INFORMATION**

**Table 2. Common Load Impedances Vs Low Frequency Output Characteristics in SE Mode**

<b>R<sub>L</sub></b>	<b>C<sub>C</sub></b>	<b>Lowest Frequency</b>
3 Ω	330 μF	161 Hz
4 Ω	330 μF	120 Hz
8 Ω	330 μF	60 Hz
32 Ω	330 μF	15 Hz
10,000 Ω	330 μF	0.05 Hz
47,000 Ω	330 μF	0.01 Hz

As Table 2 indicates, most of the bass response is attenuated into a 4-Ω load, an 8-Ω load is adequate, headphone response is good, and drive into line level inputs (a home stereo for example) is exceptional.

**using low-ESR capacitors**

Low-ESR capacitors are recommended throughout this applications section. A real (as opposed to ideal) capacitor can be modeled simply as a resistor in series with an ideal capacitor. The voltage drop across this resistor minimizes the beneficial effects of the capacitor in the circuit. The lower the equivalent value of this resistance the more the real capacitor behaves like an ideal capacitor.

**bridged-tied load versus single-ended mode**

Figure 44 shows a Class-AB audio power amplifier (APA) in a BTL configuration. The TPA0212 BTL amplifier consists of two Class-AB amplifiers driving both ends of the load. There are several potential benefits to this differential drive configuration, but initially consider power to the load. The differential drive to the speaker means that as one side is slewing up, the other side is slewing down, and vice versa. This in effect doubles the voltage swing on the load as compared to a ground referenced load. Plugging  $2 \times V_{O(PP)}$  into the power equation, where voltage is squared, yields 4x the output power from the same supply rail and load impedance (see equation 5).

$$V_{(rms)} = \frac{V_{O(PP)}}{2\sqrt{2}} \tag{5}$$

$$Power = \frac{V_{(rms)}^2}{R_L}$$



**APPLICATION INFORMATION**

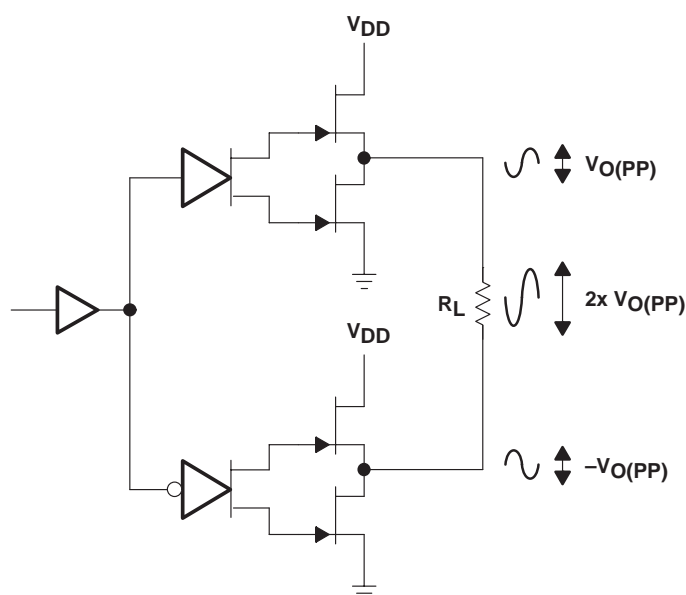
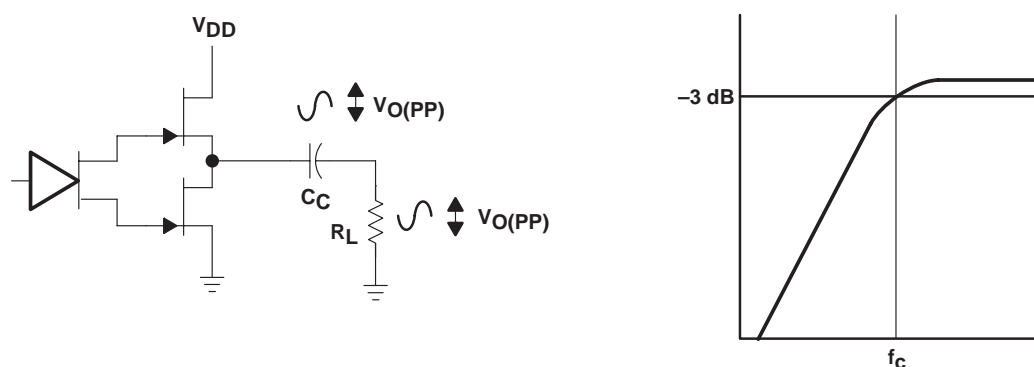

**Figure 44. Bridge-Tied Load Configuration**

In a typical computer sound channel operating at 5 V, bridging raises the power into an 8-Ω speaker from a singled-ended (SE, ground reference) limit of 250 mW to 1 W. In sound power that is a 6-dB improvement — which is loudness that can be heard. In addition to increased power there are frequency response concerns. Consider the single-supply SE configuration shown in Figure 45. A coupling capacitor is required to block the dc offset voltage from reaching the load. These capacitors can be quite large (approximately 33 μF to 1000 μF) so they tend to be expensive, heavy, occupy valuable PCB area, and have the additional drawback of limiting low-frequency performance of the system. This frequency limiting effect is due to the high pass filter network created with the speaker impedance and the coupling capacitance and is calculated with equation 6.

$$f_c = \frac{1}{2\pi R_L C_C} \tag{6}$$

For example, a 68-μF capacitor with an 8-Ω speaker would attenuate low frequencies below 293 Hz. The BTL configuration cancels the dc offsets, which eliminates the need for the blocking capacitors. Low-frequency performance is then limited only by the input network and speaker response. Cost and PCB space are also minimized by eliminating the bulky coupling capacitor.



**Figure 45. Single-Ended Configuration and Frequency Response**

# TPA0212

## STEREO 2-W AUDIO POWER AMPLIFIER

### WITH FOUR SELECTABLE GAIN SETTINGS AND MUX CONTROL

SLOS284 – NOVEMBER 1999

#### APPLICATION INFORMATION

Increasing power to the load does carry a penalty of increased internal power dissipation. The increased dissipation is understandable considering that the BTL configuration produces 4× the output power of the SE configuration. Internal dissipation versus output power is discussed further in the *crest factor and thermal considerations* section.

#### single-ended operation

In SE mode (see Figure 44 and Figure 45), the load is driven from the primary amplifier output for each channel (OUT+, terminals 21 and 4).

The amplifier switches single-ended operation when the SE/BTL terminal is held high. This puts the negative outputs in a high-impedance state, and reduces the amplifier's gain to 1 V/V.

#### input MUX operation

The input MUX allows two separate inputs to be applied to the amplifier. This allows the designer to choose which input is active independent of the state of the SE/BTL terminal. When the HP/LINE terminal is held high, the headphone inputs are active. When the HP/LINE terminal is held low, the line BTL inputs are active.

#### BTL amplifier efficiency

Class-AB amplifiers are notoriously inefficient. The primary cause of these inefficiencies is voltage drop across the output stage transistors. There are two components of the internal voltage drop. One is the headroom or dc voltage drop that varies inversely to output power. The second component is due to the sinewave nature of the output. The total voltage drop can be calculated by subtracting the RMS value of the output voltage from  $V_{DD}$ . The internal voltage drop multiplied by the RMS value of the supply current,  $I_{DD\text{rms}}$ , determines the internal power dissipation of the amplifier.

An easy-to-use equation to calculate efficiency starts out as being equal to the ratio of power from the power supply to the power delivered to the load. To accurately calculate the RMS and average values of power in the load and in the amplifier, the current and voltage waveform shapes must first be understood (see Figure 46).

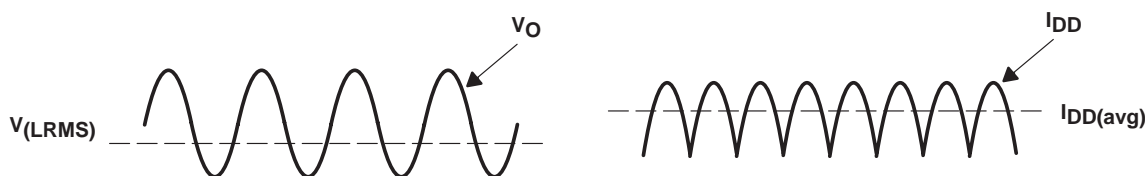

Figure 46. Voltage and Current Waveforms for BTL Amplifiers

Although the voltages and currents for SE and BTL are sinusoidal in the load, currents from the supply are very different between SE and BTL configurations. In an SE application the current waveform is a half-wave rectified shape, whereas in BTL it is a full-wave rectified waveform. This means RMS conversion factors are different. Keep in mind that for most of the waveform both the push and pull transistors are not on at the same time, which supports the fact that each amplifier in the BTL device only draws current from the supply for half the waveform. The following equations are the basis for calculating amplifier efficiency.

**APPLICATION INFORMATION**

$$\text{Efficiency of a BTL amplifier} = \frac{P_L}{P_{SUP}} \quad (7)$$

Where:

$$P_L = \frac{V_{L\text{rms}}^2}{R_L}, \text{ and } V_{LRMS} = \frac{V_P}{\sqrt{2}}, \text{ therefore, } P_L = \frac{V_P^2}{2R_L}$$

$$\text{and } P_{SUP} = V_{DD} I_{DD\text{avg}} \quad \text{and} \quad I_{DD\text{avg}} = \frac{1}{\pi} \int_0^\pi \frac{V_P}{R_L} \sin(t) dt = \frac{1}{\pi} \times \frac{V_P}{R_L} [\cos(t)]_0^\pi = \frac{2V_P}{\pi R_L}$$

Therefore,

$$P_{SUP} = \frac{2 V_{DD} V_P}{\pi R_L}$$

substituting  $P_L$  and  $P_{SUP}$  into equation 7,

$$\text{Efficiency of a BTL amplifier} = \frac{\frac{V_P^2}{2R_L}}{\frac{2 V_{DD} V_P}{\pi R_L}} = \frac{\pi V_P}{4 V_{DD}}$$

Where:

$$V_P = \sqrt{2 P_L R_L}$$

Therefore,

$$\eta_{BTL} = \frac{\pi \sqrt{2 P_L R_L}}{4 V_{DD}} \quad (8)$$

$P_L$  = Power delivered to load  
 $P_{SUP}$  = Power drawn from power supply  
 $V_{LRMS}$  = RMS voltage on BTL load  
 $R_L$  = Load resistance  
 $V_P$  = Peak voltage on BTL load  
 $I_{DD\text{avg}}$  = Average current drawn from the power supply  
 $V_{DD}$  = Power supply voltage  
 $\eta_{BTL}$  = Efficiency of a BTL amplifier

Table 3 employs equation 8 to calculate efficiencies for four different output power levels. Note that the efficiency of the amplifier is quite low for lower power levels and rises sharply as power to the load is increased resulting in a nearly flat internal power dissipation over the normal operating range. Note that the internal dissipation at full output power is less than in the half power range. Calculating the efficiency for a specific system is the key to proper power supply design. For a stereo 1-W audio system with 8-Ω loads and a 5-V supply, the maximum draw on the power supply is almost 3.25 W.

**Table 3. Efficiency Vs Output Power in 5-V 8-Ω BTL Systems**

Output Power (W)	Efficiency (%)	Peak Voltage (V)	Internal Dissipation (W)
0.25	31.4	2.00	0.55
0.50	44.4	2.83	0.62
1.00	62.8	4.00	0.59
1.25	70.2	4.47†	0.53

† High peak voltages cause the THD to increase.

A final point to remember about Class-AB amplifiers (either SE or BTL) is how to manipulate the terms in the efficiency equation to utmost advantage when possible. Note that in equation 8,  $V_{DD}$  is in the denominator. This indicates that as  $V_{DD}$  goes down, efficiency goes up.

**TPA0212**  
**STEREO 2-W AUDIO POWER AMPLIFIER**  
**WITH FOUR SELECTABLE GAIN SETTINGS AND MUX CONTROL**  
 SLOS284 – NOVEMBER 1999

**APPLICATION INFORMATION**

**crest factor and thermal considerations**

Class-AB power amplifiers dissipate a significant amount of heat in the package under normal operating conditions. A typical music CD requires 12 dB to 15 dB of dynamic range, or headroom above the average power output, to pass the loudest portions of the signal without distortion. In other words, music typically has a crest factor between 12 dB and 15 dB. When determining the optimal ambient operating temperature, the internal dissipated power at the average output power level must be used. From the TPA0212 data sheet, one can see that when the TPA0212 is operating from a 5-V supply into a 3-Ω speaker 4-W peaks are available. Converting watts to dB:

$$P_{dB} = 10 \text{Log} \frac{P_W}{P_{ref}} = 10 \text{Log} \frac{4 \text{ W}}{1 \text{ W}} = 6 \text{ dB} \tag{9}$$

Subtracting the headroom restriction to obtain the average listening level without distortion yields:

- 6 dB – 15 dB = –9 dB (15 dB crest factor)
- 6 dB – 12 dB = –6 dB (12 dB crest factor)
- 6 dB – 9 dB = –3 dB (9 dB crest factor)
- 6 dB – 6 dB = 0 dB (6 dB crest factor)
- 6 dB – 3 dB = 3 dB (3 dB crest factor)

Converting dB back into watts:

$$P_W = 10^{P_{dB}/10} \times P_{ref} \tag{10}$$

- = 63 mW (18 dB crest factor)
- = 125 mW (15 dB crest factor)
- = 250 mW (9 dB crest factor)
- = 500 mW (6 dB crest factor)
- = 1000 mW (3 dB crest factor)
- = 2000 mW (15 dB crest factor)

This is valuable information to consider when attempting to estimate the heat dissipation requirements for the amplifier system. Comparing the absolute worst case, which is 2 W of continuous power output with a 3 dB crest factor, against 12 dB and 15 dB applications drastically affects maximum ambient temperature ratings for the system. Using the power dissipation curves for a 5-V, 3-Ω system, the internal dissipation in the TPA0212 and maximum ambient temperatures is shown in Table 4.

**Table 4. TPA0212 Power Rating, 5-V, 3-Ω, Stereo**

PEAK OUTPUT POWER (W)	AVERAGE OUTPUT POWER	POWER DISSIPATION (W/Channel)	MAXIMUM AMBIENT TEMPERATURE
4	2 W (3 dB)	1.7	–3°C
4	1000 mW (6 dB)	1.6	6°C
4	500 mW (9 dB)	1.4	24°C
4	250 mW (12 dB)	1.1	51°C
4	125 mW (15 dB)	0.8	78°C
4	63 mW (18 dB)	0.6	96°C



**APPLICATION INFORMATION**

**crest factor and thermal considerations (continued)**

**Table 5. TPA0212 Power Rating, 5-V, 8-Ω, Stereo**

PEAK OUTPUT POWER	AVERAGE OUTPUT POWER	POWER DISSIPATION (W/Channel)	MAXIMUM AMBIENT TEMPERATURE
2.5 W	1250 mW (3 dB crest factor)	0.55	100°C
2.5 W	1000 mW (4 dB crest factor)	0.62	94°C
2.5 W	500 mW (7 dB crest factor)	0.59	97°C
2.5 W	250 mW (10 dB crest factor)	0.53	102°C

The maximum dissipated power,  $P_{Dmax}$ , is reached at a much lower output power level for an 8-Ω load than for a 3-Ω load. As a result, this simple formula for calculating  $P_{Dmax}$  may be used for an 8-Ω application:

$$P_{Dmax} = \frac{2V_{DD}^2}{\pi^2 R_L} \quad (11)$$

However, in the case of a 3-Ω load, the  $P_{Dmax}$  occurs at a point well above the normal operating power level. The amplifier may therefore be operated at a higher ambient temperature than required by the  $P_{Dmax}$  formula for a 3-Ω load.

The maximum ambient temperature depends on the heat sinking ability of the PCB system. The derating factor for the PWP package is shown in the dissipation rating table (see page 4). Converting this to  $\Theta_{JA}$ :

$$\Theta_{JA} = \frac{1}{\text{Derating Factor}} = \frac{1}{0.022} = 45^\circ\text{C/W} \quad (12)$$

To calculate maximum ambient temperatures, first consider that the numbers from the dissipation graphs are per channel so the dissipated power needs to be doubled for two channel operation. Given  $\Theta_{JA}$ , the maximum allowable junction temperature, and the total internal dissipation, the maximum ambient temperature can be calculated with the following equation. The maximum recommended junction temperature for the TPA0212 is 150°C. The internal dissipation figures are taken from the Power Dissipation vs Output Power graphs.

$$\begin{aligned} T_{A \text{ Max}} &= T_{J \text{ Max}} - \Theta_{JA} P_D \\ &= 150 - 45(0.6 \times 2) = 96^\circ\text{C} \text{ (15 dB crest factor)} \end{aligned} \quad (13)$$

**NOTE:**

Internal dissipation of 0.6 W is estimated for a 2-W system with 15 dB crest factor per channel.

Tables 4 and 5 show that for some applications no airflow is required to keep junction temperatures in the specified range. The TPA0212 is designed with thermal protection that turns the device off when the junction temperature surpasses 150°C to prevent damage to the IC. Tables 4 and 5 were calculated for maximum listening volume without distortion. When the output level is reduced the numbers in the table change significantly. Also, using 8-Ω speakers dramatically increases the thermal performance by increasing amplifier efficiency.

**TPA0212**  
**STEREO 2-W AUDIO POWER AMPLIFIER**  
**WITH FOUR SELECTABLE GAIN SETTINGS AND MUX CONTROL**  
 SLOS284 – NOVEMBER 1999

**APPLICATION INFORMATION**

**SE/BTL operation**

The ability of the TPA0212 to easily switch between BTL and SE modes is one of its most important cost saving features. This feature eliminates the requirement for an additional headphone amplifier in applications where internal stereo speakers are driven in BTL mode but external headphone or speakers must be accommodated. Internal to the TPA0212, two separate amplifiers drive OUT+ and OUT-. The SE/BTL input (terminal 15) controls the operation of the follower amplifier that drives LOUT- and ROUT- (terminals 9 and 16). When SE/BTL is held low, the amplifier is on and the TPA0212 is in the BTL mode. When SE/BTL is held high, the OUT- amplifiers are in a high output impedance state, which configures the TPA0212 as an SE driver from LOUT+ and ROUT+ (terminals 4 and 21). I<sub>DD</sub> is reduced by approximately one-half in SE mode. Control of the SE/BTL input can be from a logic-level CMOS source or, more typically, from a resistor divider network as shown in Figure 47.

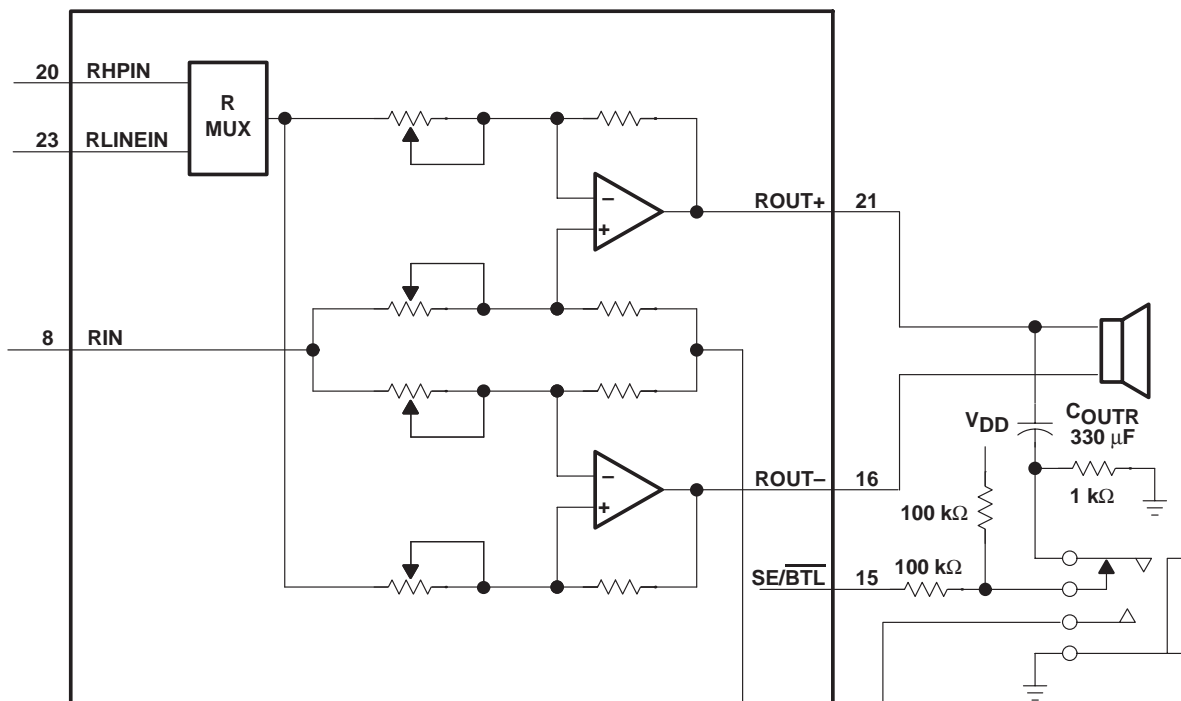

**Figure 47. TPA0212 Resistor Divider Network Circuit**

Using a readily available 1/8-in. (3.5 mm) stereo headphone jack, the control switch is closed when no plug is inserted. When closed the 100-kΩ/1-kΩ divider pulls the SE/BTL input low. When a plug is inserted, the 1-kΩ resistor is disconnected and the SE/BTL input is pulled high. When the input goes high, the OUT- amplifier is shut down causing the speaker to mute (virtually open-circuits the speaker). The OUT+ amplifier then drives through the output capacitor (C<sub>O</sub>) into the headphone jack.

## APPLICATION INFORMATION

### PC BEEP operation

The PC BEEP input allows a system beep to be sent directly from a computer through the amplifier to the speakers with few external components. The input is activated automatically. When the PC BEEP input is active, both of the LINEIN and HPIN inputs are deselected and both the left and right channels are driven in BTL mode with the signal from PC BEEP. The gain from the PC BEEP input to the speakers is fixed at 0.3 V/V and is independent of the volume setting. When the PC BEEP input is deselected, the amplifier will return to the previous operating mode and volume setting. Furthermore, if the amplifier is in shutdown mode, activating PC BEEP will take the device out of shutdown and output the PC BEEP signal, then return the amplifier to shutdown mode.

The preferred input signal is a square wave or pulse train with an amplitude of 1 V<sub>pp</sub> or greater. To be accurately detected, the signal must have a minimum of 1 V<sub>pp</sub> amplitude, rise and fall times of less than 0.1 μs and a minimum of 8 rising edges. When the signal is no longer detected, the amplifier will return to its previous operating mode and volume setting.

If it is desired to ac-couple the PC BEEP input, the value of the coupling capacitor should be chosen to satisfy equation 14:

$$C_{PCB} \geq \frac{1}{2\pi f_{PCB} (100 \text{ k}\Omega)} \quad (14)$$

The PC BEEP input can also be dc-coupled to avoid using this coupling capacitor. The pin normally sits at midrail when no signal is present.

### shutdown modes

The TPA0212 employs a shutdown mode of operation designed to reduce supply current, I<sub>DD</sub>, to the absolute minimum level during periods of nonuse for battery-power conservation. The  $\overline{\text{SHUTDOWN}}$  input terminal should be held high during normal operation when the amplifier is in use. Pulling  $\overline{\text{SHUTDOWN}}$  low causes the outputs to mute and the amplifier to enter a low-current state, I<sub>DD</sub> = 150 μA.  $\overline{\text{SHUTDOWN}}$  should never be left unconnected because amplifier operation would be unpredictable.

**Table 6. HP/LINE, SE/BTL, and Shutdown Functions**

INPUTS†			AMPLIFIER STATE	
HP/LINE	SE/BTL	$\overline{\text{SHUTDOWN}}$	INPUT	OUTPUT
X	X	Low	X	Mute
Low	Low	High	Line	BTL
Low	High	High	Line	SE
High	Low	High	HP	BTL
High	High	High	HP	SE

† Inputs should never be left unconnected.  
 X = do not care

**TPA0212**  
**STEREO 2-W AUDIO POWER AMPLIFIER**  
**WITH FOUR SELECTABLE GAIN SETTINGS AND MUX CONTROL**

SLOS284 – NOVEMBER 1999

**MECHANICAL DATA**

**PWP (R-PDSO-G\*\*)**

**PowerPAD™ PLASTIC SMALL-OUTLINE PACKAGE**

**20-PIN SHOWN**

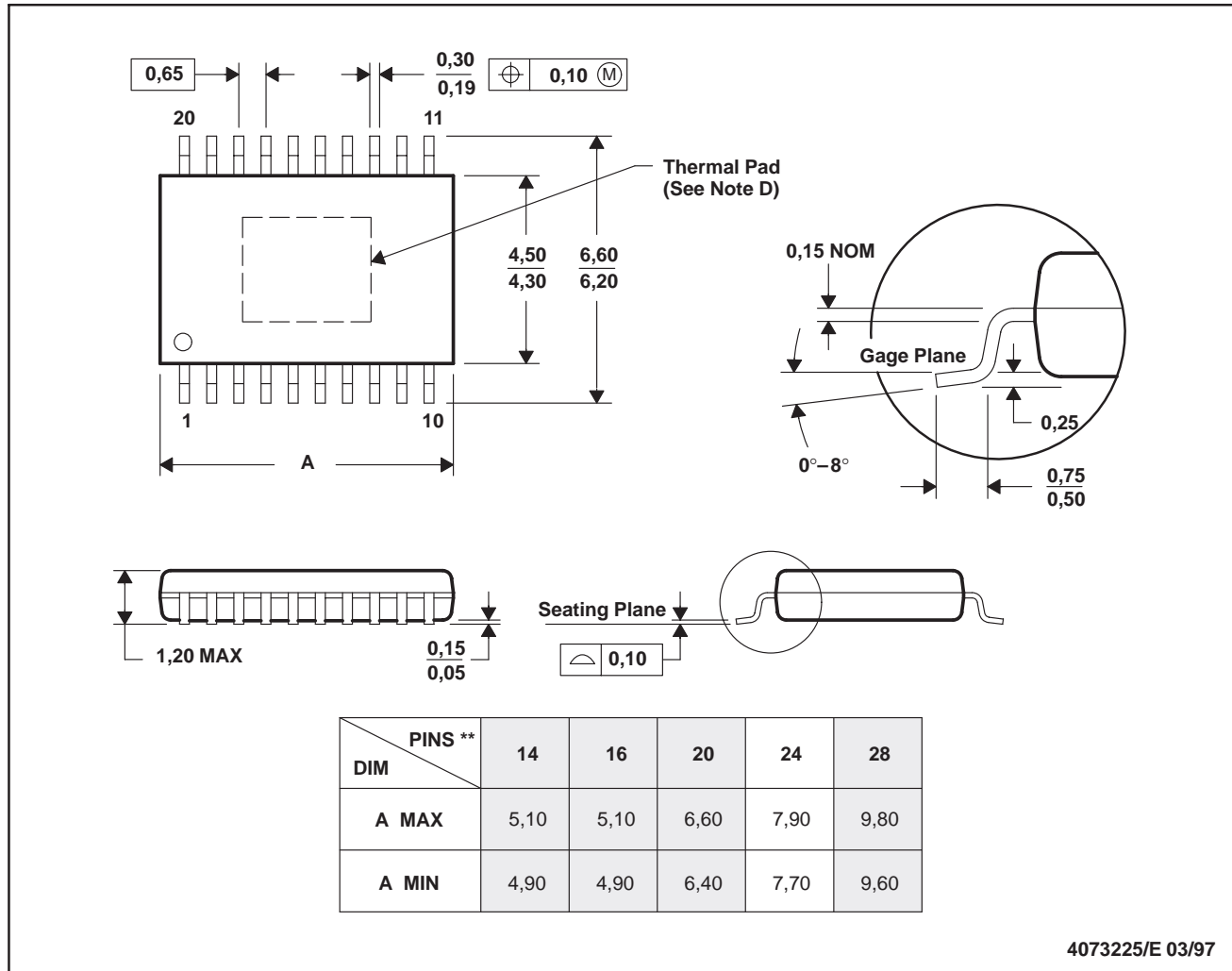

- NOTES: A. All linear dimensions are in millimeters.  
 B. This drawing is subject to change without notice.  
 C. Body dimensions do not include mold flash or protrusions.  
 D. The package thermal performance may be enhanced by bonding the thermal pad to an external thermal plane. This pad is electrically and thermally connected to the backside of the die and terminals 1, 12, 13, and 24. The dimensions of the thermal pad are 2.40 mm x 4.70 mm (maximum). The pad is centered on the bottom of the package.  
 E. Falls within JEDEC MO-153

PowerPAD is a trademark of Texas Instruments Incorporated.



POST OFFICE BOX 655303 • DALLAS, TEXAS 75265



## **IMPORTANT NOTICE**

Texas Instruments and its subsidiaries (TI) reserve the right to make changes to their products or to discontinue any product or service without notice, and advise customers to obtain the latest version of relevant information to verify, before placing orders, that information being relied on is current and complete. All products are sold subject to the terms and conditions of sale supplied at the time of order acknowledgement, including those pertaining to warranty, patent infringement, and limitation of liability.

TI warrants performance of its semiconductor products to the specifications applicable at the time of sale in accordance with TI's standard warranty. Testing and other quality control techniques are utilized to the extent TI deems necessary to support this warranty. Specific testing of all parameters of each device is not necessarily performed, except those mandated by government requirements.

CERTAIN APPLICATIONS USING SEMICONDUCTOR PRODUCTS MAY INVOLVE POTENTIAL RISKS OF DEATH, PERSONAL INJURY, OR SEVERE PROPERTY OR ENVIRONMENTAL DAMAGE ("CRITICAL APPLICATIONS"). TI SEMICONDUCTOR PRODUCTS ARE NOT DESIGNED, AUTHORIZED, OR WARRANTED TO BE SUITABLE FOR USE IN LIFE-SUPPORT DEVICES OR SYSTEMS OR OTHER CRITICAL APPLICATIONS. INCLUSION OF TI PRODUCTS IN SUCH APPLICATIONS IS UNDERSTOOD TO BE FULLY AT THE CUSTOMER'S RISK.

In order to minimize risks associated with the customer's applications, adequate design and operating safeguards must be provided by the customer to minimize inherent or procedural hazards.

TI assumes no liability for applications assistance or customer product design. TI does not warrant or represent that any license, either express or implied, is granted under any patent right, copyright, mask work right, or other intellectual property right of TI covering or relating to any combination, machine, or process in which such semiconductor products or services might be or are used. TI's publication of information regarding any third party's products or services does not constitute TI's approval, warranty or endorsement thereof.