

TL070 JFET-INPUT OPERATIONAL AMPLIFIER

SLOS121A – NOVEMBER 1993 – REVISED AUGUST 1994

- Low Power Consumption
- Wide Common-Mode and Differential Voltage Ranges
- Low Input Bias and Offset Currents
- Output Short-Circuit Protection
- Low Total Harmonic Distortion
0.003% Typ
- Low Noise
 $V_n = 18 \text{ nV}/\sqrt{\text{Hz}}$ Typ at $f = 1 \text{ kHz}$
- High Input Impedance . . . JFET Input Stage
- Common-Mode Input Voltage Range
Includes V_{CC+}
- Latch-Up-Free Operation
- High Slew Rate . . . 13 $\text{V}/\mu\text{s}$ Typ

description

The JFET-input TL070 operational amplifier is designed as the lower-noise version of the TL080 amplifier with low input bias and offset currents and fast slew rate. The low harmonic distortion and low noise make the TL070 ideally suited for high-fidelity and audio preamplifier applications. This amplifier features JFET inputs (for high input impedance) coupled with bipolar output stages integrated on a single monolithic chip.

The TL070C device is characterized for operation from 0°C to 70°C. The TL070I device is characterized for operation from –40°C to 85°C. The TL070M device is characterized for operation from –55°C to 125°C.

D, P, OR PW PACKAGE
(TOP VIEW)

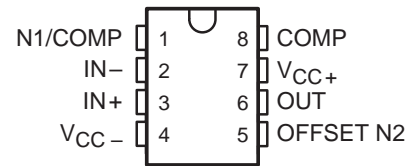

symbol

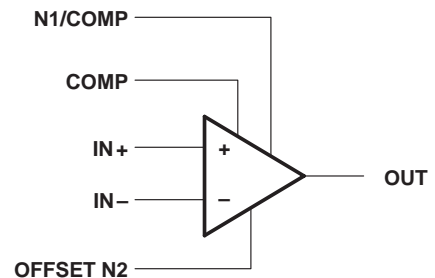

AVAILABLE OPTIONS

T_A	V_{IO}^{max} AT 25°C	PACKAGE		
		SMALL OUTLINE (D)	PLASTIC DIP (P)	TSSOP (PW)
0°C to 70°C	10 mV	TL070CD	TL070CP	TL070CPW
–40°C to 85°C	10 mV	TL070ID	TL070IP	—
–55°C to 125°C	10 mV	TL070MD	TL070MP	—

PRODUCTION DATA information is current as of publication date. Products conform to specifications per the terms of Texas Instruments standard warranty. Production processing does not necessarily include testing of all parameters.

 **TEXAS
INSTRUMENTS**

POST OFFICE BOX 655303 • DALLAS, TEXAS 75265

Copyright © 1994, Texas Instruments Incorporated

TL070 JFET-INPUT OPERATIONAL AMPLIFIER

SLOS121A – NOVEMBER 1993 – REVISED AUGUST 1994

schematic

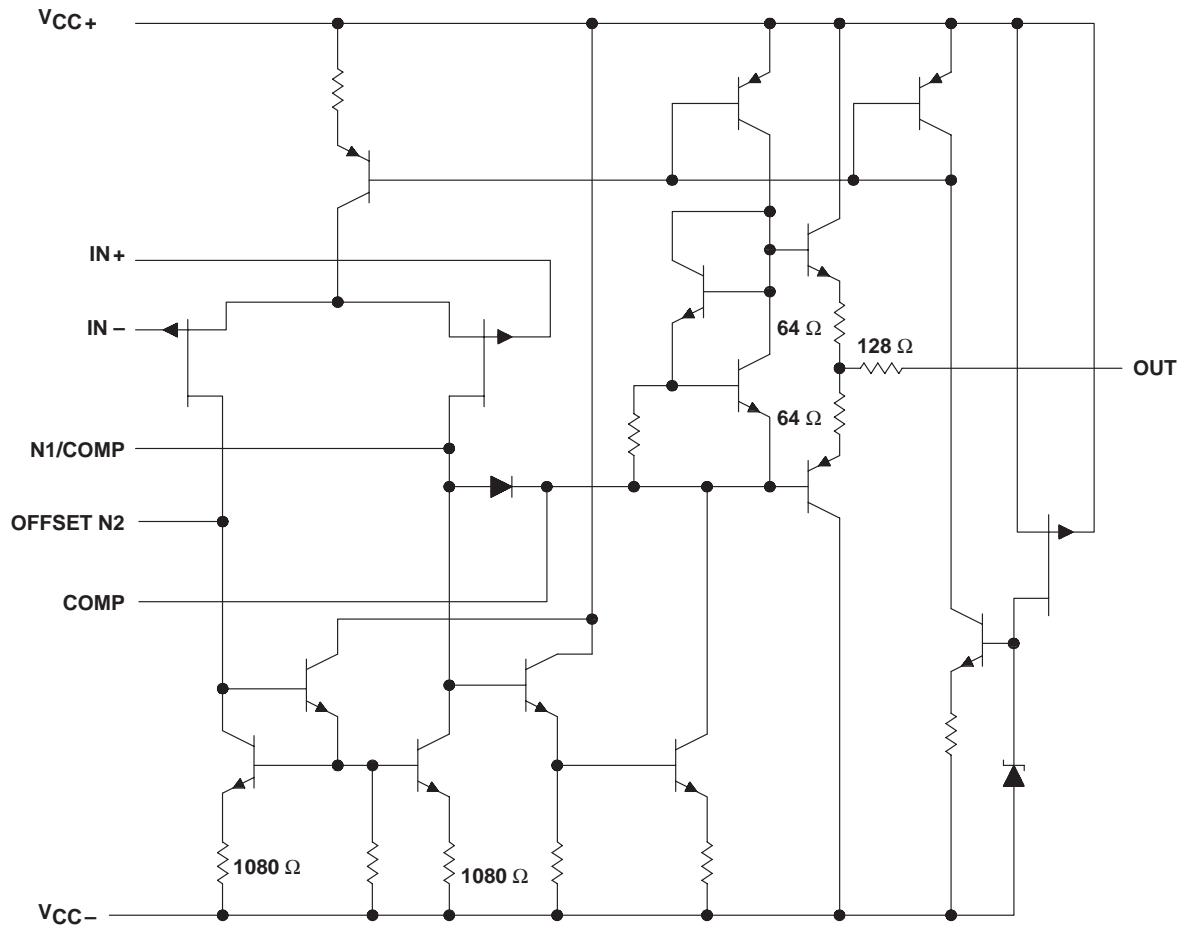

All component values shown are nominal.

COMPONENT COUNT †	
Transistors	13
Diodes	2
Resistors	10
epi-FET	1
JFET	2

† Includes all bias and trim circuitry

TL070
JFET-INPUT
OPERATIONAL AMPLIFIER

SLOS121A – NOVEMBER 1993 – REVISED AUGUST 1994

absolute maximum ratings over operating free-air temperature range (unless otherwise noted)†

Supply voltage, V_{CC+} (see Note 1)	18 V
Supply voltage, V_{CC-}	-18 V
Differential input voltage, V_{ID} (see Note 2)	± 30 V
Input voltage, V_I (see Notes 1 and 3)	± 15 V
Duration of short-circuit current (see Note 4)	unlimited
Continuous total dissipation	See Dissipation Rating Table
Operating free-air temperature range, T_A : C suffix	0°C to 70°C
I suffix	-40°C to 85°C
M suffix	-55°C to 125°C
Storage temperature range	-65°C to 150°C
Lead temperature 1,6 mm (1/16 inch) from case for 10 seconds	260°C

† Stresses beyond those listed under "absolute maximum ratings" may cause permanent damage to the device. These are stress ratings only, and functional operation of the device at these or any other conditions beyond those indicated under "recommended operating conditions" is not implied. Exposure to absolute-maximum-rated conditions for extended periods may affect device reliability.

- NOTES:
1. All voltage values, except differential voltages, are with respect to the midpoint between V_{CC+} and V_{CC-} .
 2. Differential voltages are at $IN+$ with respect to $IN-$.
 3. The magnitude of the input voltage must never exceed the magnitude of the supply voltage or 15 V, whichever is less.
 4. The output may be shorted to ground or to either supply. Temperature and/or supply voltages must be limited to ensure that the dissipation rating is not exceeded.

DISSIPATION RATING TABLE

PACKAGE	$T_A \leq 25^\circ\text{C}$ POWER RATING	DERATING FACTOR	DERATE ABOVE T_A	$T_A = 70^\circ\text{C}$ POWER RATING	$T_A = 85^\circ\text{C}$ POWER RATING	$T_A = 125^\circ\text{C}$ POWER RATING
D	680 mW	5.8 mW/°C	33°C	464 mW	377 mW	145 mW
P	680 mW	8.0 mW/°C	65°C	640 mW	520 mW	200 mW
PW	525 mW	4.2 mW/°C	70°C	336 mW	N/A	N/A



TL070
JFET-INPUT
OPERATIONAL AMPLIFIER

SLOS121A – NOVEMBER 1993 – REVISED AUGUST 1994

electrical characteristics, $V_{CC\pm} = \pm 15$ V (unless otherwise noted)

PARAMETER	TEST CONDITIONS	T_A †	TL070C			UNIT
			MIN	TYP	MAX	
V_{IO} Input offset voltage	$V_O = 0, R_S = 50 \Omega$	25°C		3	10	mV
		Full range			13	
α_{VIO} Temperature coefficient of input offset voltage	$V_O = 0, R_S = 50 \Omega$	Full range		18		$\mu V/^\circ C$
I_{IO} Input offset current	$V_O = 0$	25°C		5	100	pA
		Full range			10	nA
I_{IB} Input bias current‡	$V_O = 0$	25°C		65	200	pA
		Full range			7	nA
V_{ICR} Common-mode input voltage range		25°C	± 11	-12 to 15		V
V_{OM} Maximum peak output voltage swing	$R_L = 10 k\Omega$	25°C	± 12	± 13.5		V
	$R_L \geq 10 k\Omega$	Full range	± 12			
	$R_L \geq 2 k\Omega$		± 10			
A_{VD} Large-signal differential voltage amplification	$V_O = \pm 10$ V, $R_L \geq 2 k\Omega$	25°C	25	200		V/mV
		Full range	15			
B_1 Unity-gain bandwidth		25°C	3			MHz
r_i Input resistance		25°C	10^{12}			Ω
CMRR Common-mode rejection ratio	$V_{IC} = V_{ICRmin}, V_O = 0, R_S = 50 \Omega$	25°C	70	100		dB
k_{SVR} Supply voltage rejection ratio ($\Delta V_{CC\pm}/\Delta V_{IO}$)	$V_{CC} = \pm 9$ V to ± 15 V, $V_O = 0, R_S = 50 \Omega$	25°C	70	100		dB
I_{CC} Supply current	$V_O = 0, \text{No load}$	25°C	1.4	2.5		mA
V_{O1}/V_{O2} Crosstalk attenuation	$A_{VD} = 100$	25°C	120			dB

† All characteristics are measured under open-loop conditions with zero common-mode voltage unless otherwise specified. Full range for T_A is 0°C to 70°C.

‡ Input bias currents of a FET-input operational amplifier are normal junction reverse currents, which are temperature sensitive as shown in Figure 5. Pulse techniques must be used that will maintain the junction temperature as close to the ambient temperature as possible.

TL070
JFET-INPUT
OPERATIONAL AMPLIFIER

SLOS121A – NOVEMBER 1993 – REVISED AUGUST 1994

electrical characteristics, $V_{CC\pm} = \pm 15$ V (unless otherwise noted)

PARAMETER	TEST CONDITIONS	T_A †	TL070I			UNIT
			MIN	TYP	MAX	
V_{IO} Input offset voltage	$V_O = 0, R_S = 50 \Omega$	25°C		3	10	mV
		Full range			13	
α_{VIO} Temperature coefficient of input offset voltage	$V_O = 0, R_S = 50 \Omega$	Full range		18		$\mu\text{V}/^\circ\text{C}$
I_{IO} Input offset current	$V_O = 0$	25°C		5	100	pA
		Full range			10	nA
I_{IB} Input bias current‡	$V_O = 0$	25°C		65	200	pA
		Full range			20	nA
V_{ICR} Common-mode input voltage range		25°C	± 11	-12 to 15		V
V_{OM} Maximum peak output voltage swing	$R_L = 10 \text{ k}\Omega$	25°C	± 12	± 13.5		V
	$R_L \geq 10 \text{ k}\Omega$	Full range	± 12			
	$R_L \geq 2 \text{ k}\Omega$		± 10			
A_{VD} Large-signal differential voltage amplification	$V_O = \pm 10 \text{ V}, R_L \geq 2 \text{ k}\Omega$	25°C	25	200		V/mV
		Full range	15			
B_1 Unity-gain bandwidth		25°C		3		MHz
r_i Input resistance		25°C		10^{12}		Ω
CMRR Common-mode rejection ratio	$V_{IC} = V_{ICRmin}, V_O = 0, R_S = 50 \Omega$	25°C	70	100		dB
k_{SVR} Supply voltage rejection ratio ($\Delta V_{CC\pm}/\Delta V_{IO}$)	$V_{CC} = \pm 9 \text{ V to } \pm 15 \text{ V}, V_O = 0, R_S = 50 \Omega$	25°C	70	100		dB
I_{CC} Supply current	$V_O = 0, \text{ No load}$	25°C		1.4	2.5	mA
V_{O1}/V_{O2} Crosstalk attenuation	$A_{VD} = 100$	25°C		120		dB

† All characteristics are measured under open-loop conditions with zero common-mode voltage unless otherwise specified. Full range for T_A is -40°C to 85°C .

‡ Input bias currents of a FET-input operational amplifier are normal junction reverse currents, which are temperature sensitive as shown in Figure 5. Pulse techniques must be used that will maintain the junction temperature as close to the ambient temperature as possible.



TL070

JFET-INPUT OPERATIONAL AMPLIFIER

SLOS121A – NOVEMBER 1993 – REVISED AUGUST 1994

electrical characteristics, $V_{CC\pm} = \pm 15$ V (unless otherwise noted)

PARAMETER	TEST CONDITIONS	T_A †	TL070M			UNIT
			MIN	TYP	MAX	
V_{IO} Input offset voltage	$V_O = 0$, $R_S = 50 \Omega$	25°C		3	10	mV
		Full range			13	
α_{VIO} Temperature coefficient of input offset voltage	$V_O = 0$, $R_S = 50 \Omega$	Full range		18		$\mu V/^\circ C$
I_{IO} Input offset current	$V_O = 0$	25°C		5	100	pA
		Full range			20	nA
I_{IB} Input bias current‡	$V_O = 0$	25°C		65	200	pA
		Full range			50	nA
V_{ICR} Common-mode input voltage range		25°C	± 11	-12 to 15		V
V_{OM} Maximum peak output voltage swing	$R_L = 10 k\Omega$	25°C	± 12	± 13.5		V
	$R_L \geq 10 k\Omega$	Full range	± 12			
	$R_L \geq 2 k\Omega$		± 10			
A_{VD} Large-signal differential voltage amplification	$V_O = \pm 10$ V, $R_L \geq 2 k\Omega$	25°C	25	200		V/mV
		Full range	15			
B_1 Unity-gain bandwidth		25°C		3		MHz
r_i Input resistance		25°C		10^{12}		Ω
CMRR Common-mode rejection ratio	$V_{IC} = V_{ICRmin}$, $R_S = 50 \Omega$, $V_O = 0$	25°C	70	100		dB
k_{SVR} Supply voltage rejection ratio ($\Delta V_{CC\pm}/\Delta V_{IO}$)	$V_{CC} = \pm 9$ V to ± 15 V, $R_S = 50 \Omega$, $V_O = 0$	25°C	70	100		dB
I_{CC} Supply current	$V_O = 0$, No load	25°C		1.4	2.5	mA
V_{O1}/V_{O2} Crosstalk attenuation	$A_{VD} = 100$	25°C		120		dB

† All characteristics are measured under open-loop conditions with zero common-mode voltage unless otherwise specified. Full range for T_A is $-55^\circ C$ to $125^\circ C$.

‡ Input bias currents of a FET-input operational amplifier are normal junction reverse currents, which are temperature sensitive as shown in Figure 5. Pulse techniques must be used that will maintain the junction temperature as close to the ambient temperature as possible.

operating characteristics, $V_{CC\pm} = \pm 15$ V, $T_A = 25^\circ C$

PARAMETER	TEST CONDITIONS	MIN	TYP	MAX	UNIT
SR Slew rate at unity gain	$V_I = 10$ V, $R_L = 2 k\Omega$, $C_L = 100$ pF, See Figure 1	8	13		V/ μs
t_r Rise time overshoot factor	$V_I = 20$ mV, $R_L = 2 k\Omega$, $C_L = 100$ pF, See Figure 1		0.1		μs
			20		%
V_n Equivalent input noise voltage	$R_S = 20 \Omega$	$f = 1$ kHz	18		nV/ \sqrt{Hz}
		$f = 10$ Hz to 10 kHz	4		μV
I_n Equivalent input noise current	$R_S = 20 \Omega$, $f = 1$ kHz		0.01		pA/ \sqrt{Hz}
THD Total harmonic distortion	$V_{O(rms)} = 10$ V, $R_S \leq 1 k\Omega$, $R_L \geq 2 k\Omega$, $f = 1$ kHz		0.003		%



PARAMETER MEASUREMENT INFORMATION

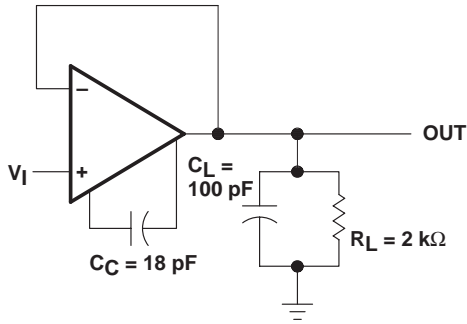

Figure 1. Unity-Gain Amplifier

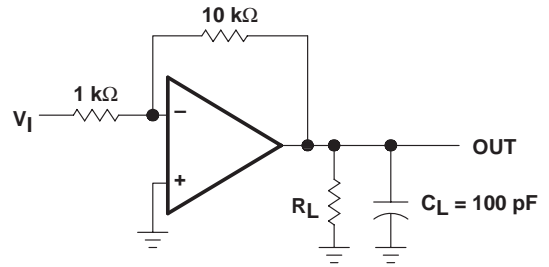

Figure 2. Gain-of-10 Inverting Amplifier

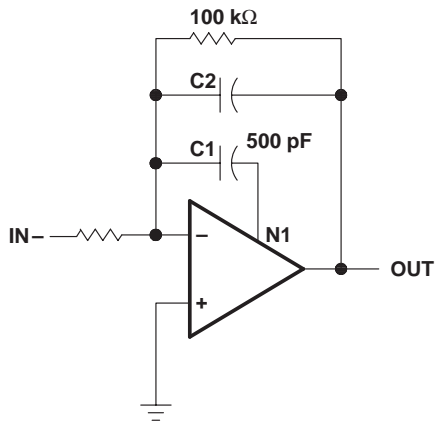

Figure 3. Feed-Forward Compensation

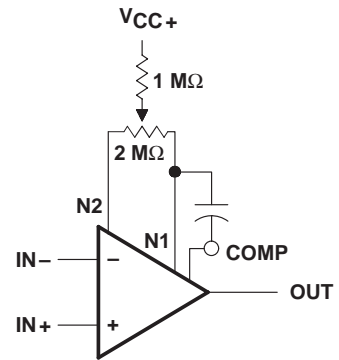

Figure 4. Input Offset Voltage Null Circuit

TL070
JFET-INPUT
OPERATIONAL AMPLIFIER

SLOS121A – NOVEMBER 1993 – REVISED AUGUST 1994

TYPICAL CHARACTERISTICS

Table of Graphs

			FIGURE
I_{IB}	Input bias current	vs Free-air temperature	5
V_{OM}	Maximum output voltage	vs Frequency	6, 7, 8
		vs Free-air temperature	9
		vs Load resistance	10
		vs Supply voltage	11
A_{VD}	Large-signal differential voltage amplification	vs Free-air temperature	12
		vs Frequency	14
A_{VD}	Differential voltage amplification	vs Frequency	13
	Phase shift	vs Frequency	14
	Normalized unity-gain bandwidth	vs Free-air temperature	15
	Normalized phase shift	vs Free-air temperature	15
CMRR	Common-mode rejection ratio	vs Free-air temperature	16
I_{CC}	Supply current	vs Supply voltage	17
		vs Free-air temperature	18
P_D	Total power dissipation	vs Free-air temperature	19
		Normalized slew rate	vs Free-air temperature
V_n	Equivalent input noise voltage	vs Frequency	21
THD	Total harmonic distortion	vs Frequency	22
		Large-signal pulse response	vs Time
V_O	Output voltage	vs Elapsed time	24



TYPICAL CHARACTERISTICS†

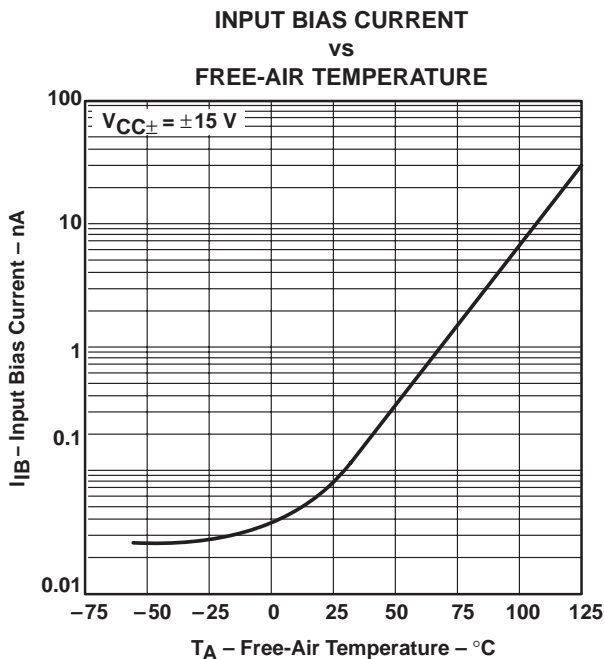

Figure 5

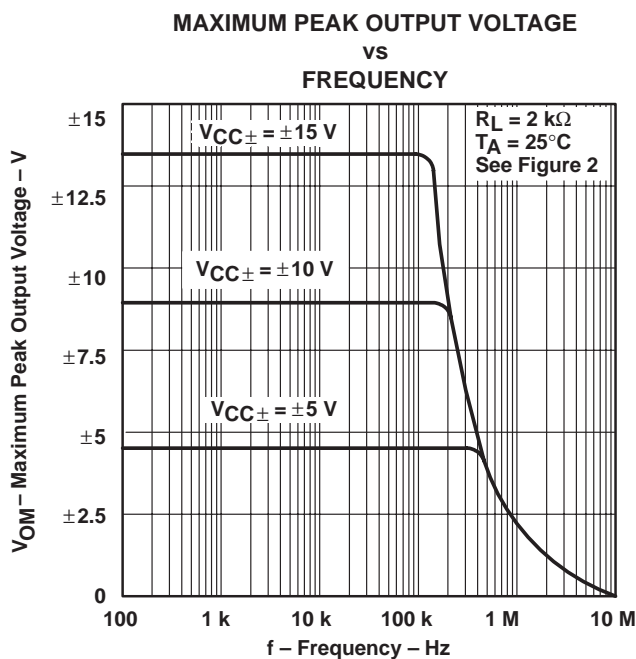

Figure 6

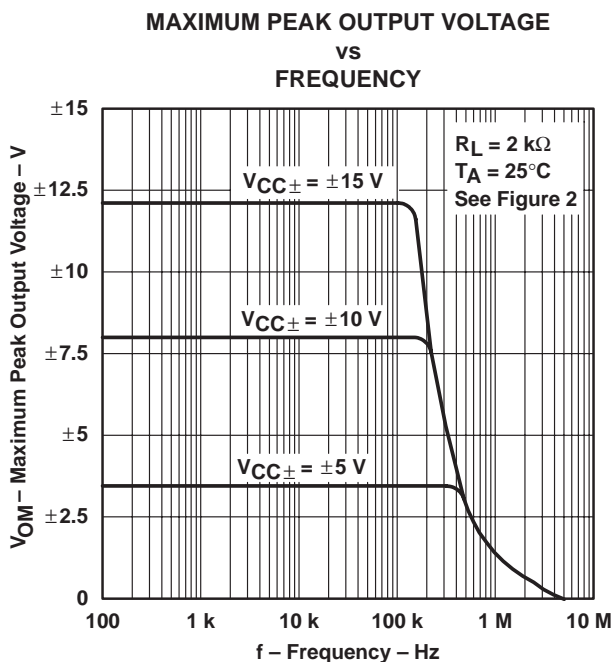

Figure 7

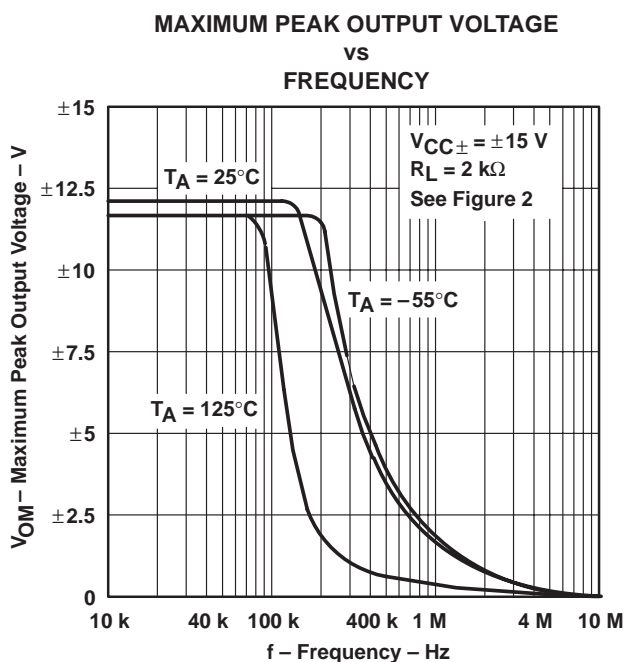

Figure 8

† Data at high and low temperatures are applicable only within the rated operating free-air temperature ranges of the various devices. An 18-pF compensation capacitor is used.

TL070
JFET-INPUT
OPERATIONAL AMPLIFIER

SLOS121A – NOVEMBER 1993 – REVISED AUGUST 1994

TYPICAL CHARACTERISTICS†

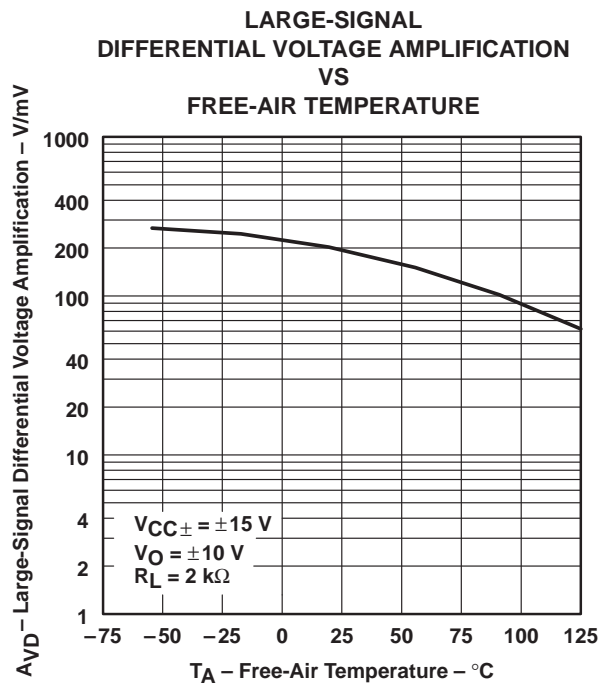
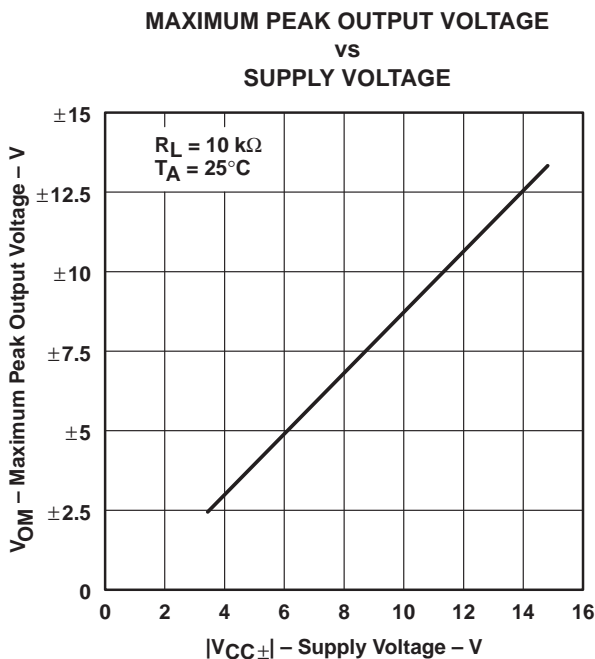
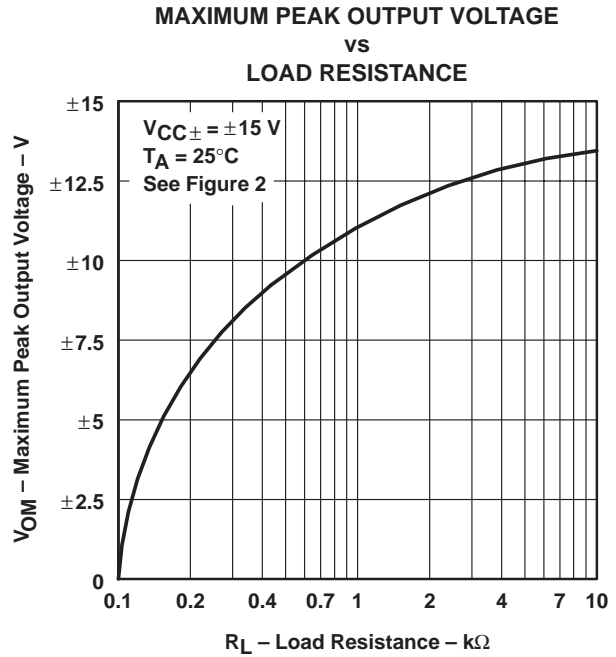
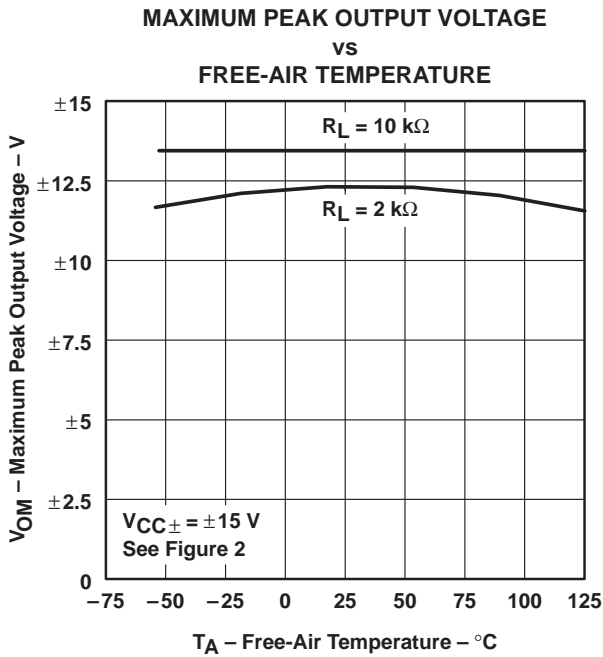

† Data at high and low temperatures are applicable only within the rated operating free-air temperature ranges of the various devices. An 18-pF compensation capacitor is used.



TYPICAL CHARACTERISTICS†

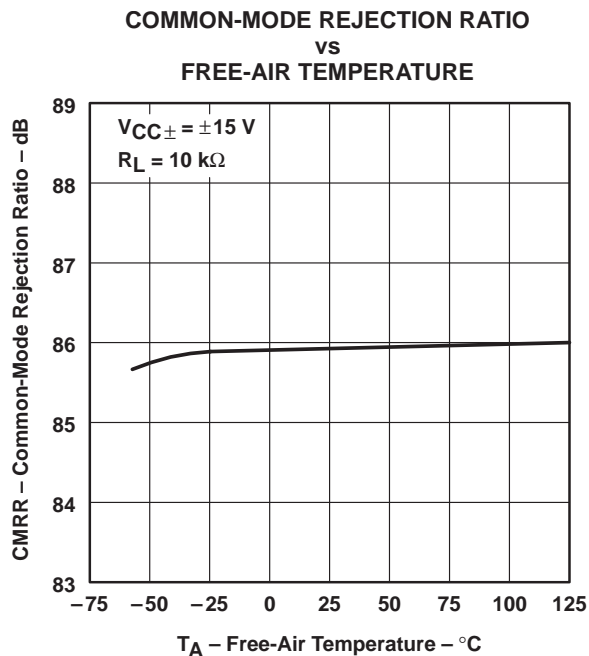
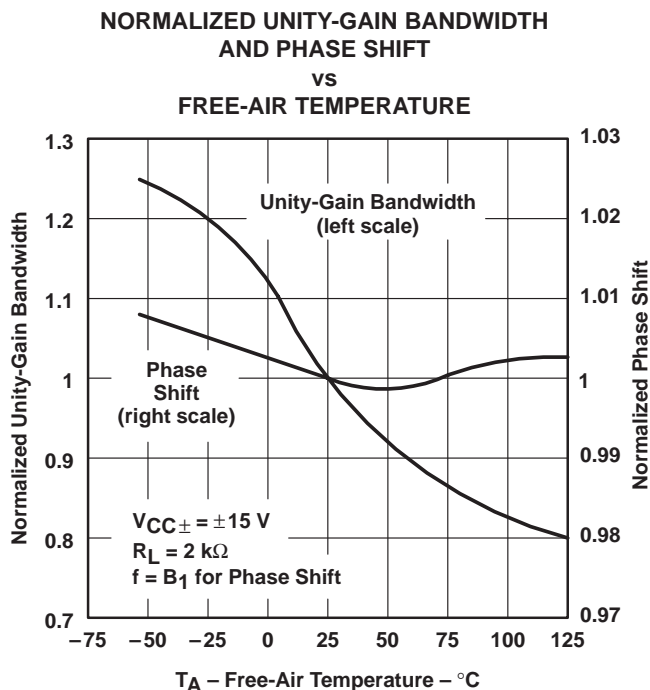
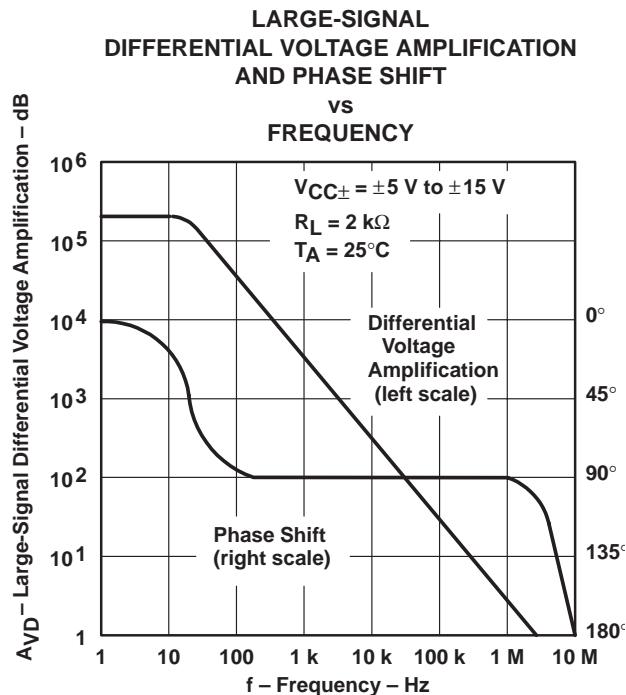
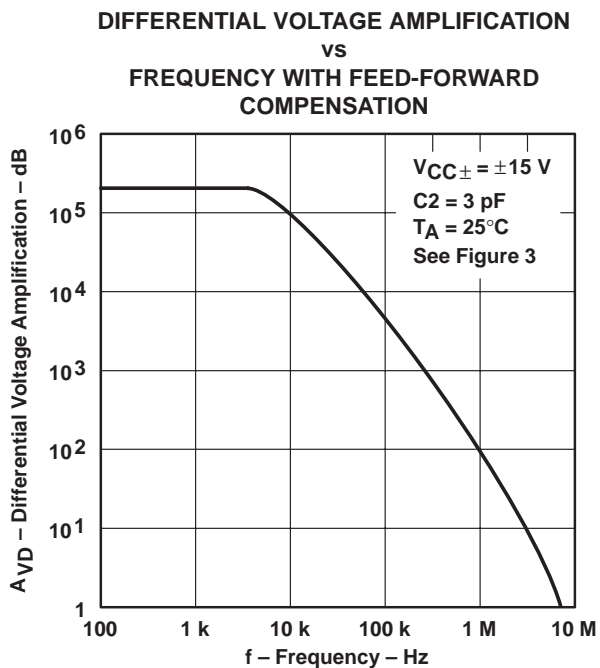

† Data at high and low temperatures are applicable only within the rated operating free-air temperature ranges of the various devices. An 18-pF compensation capacitor is used.

TL070
JFET-INPUT
OPERATIONAL AMPLIFIER

SLOS121A – NOVEMBER 1993 – REVISED AUGUST 1994

TYPICAL CHARACTERISTICS†

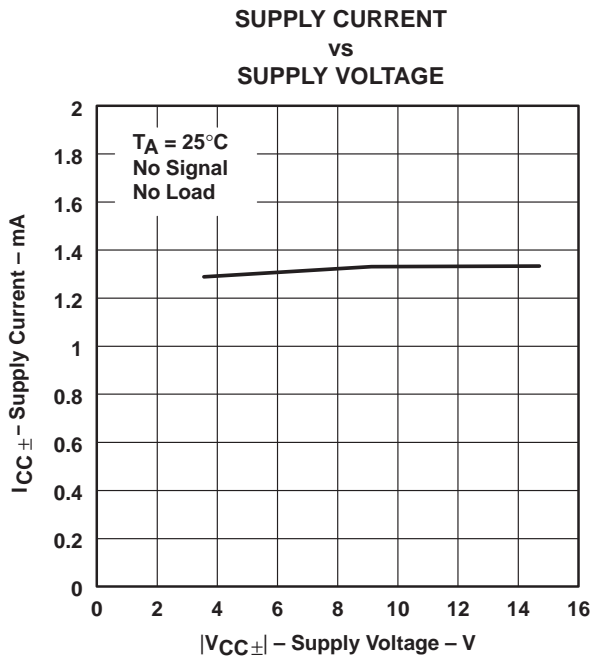

Figure 17

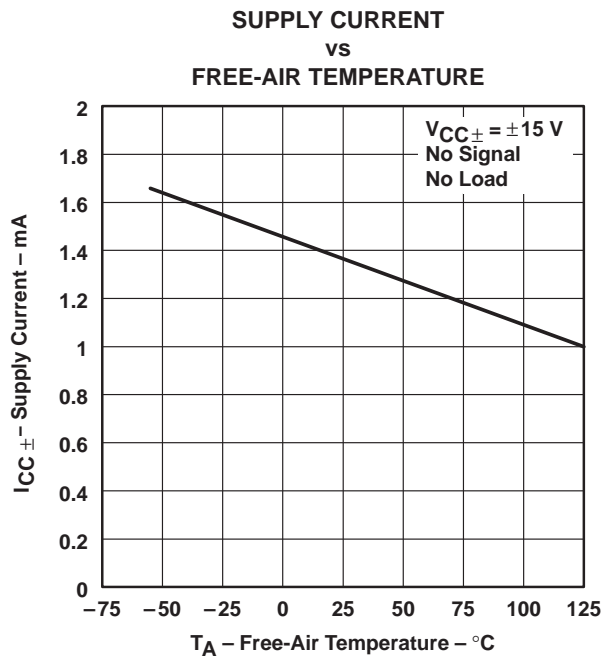

Figure 18

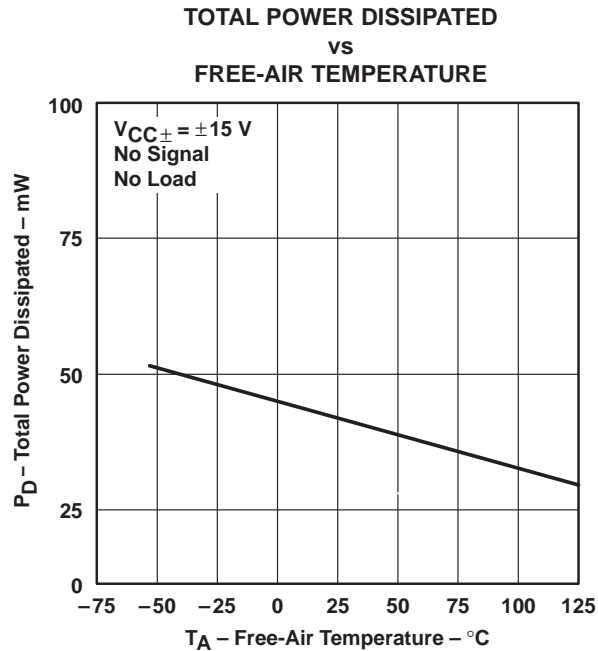

Figure 19

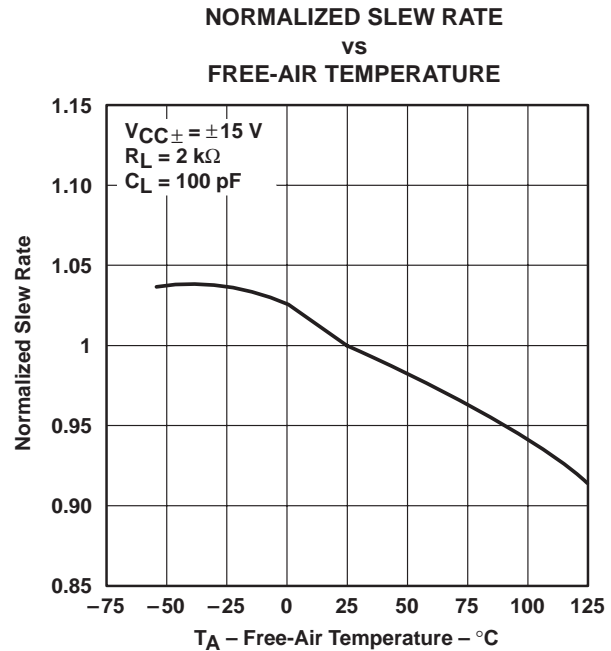

Figure 20

† Data at high and low temperatures are applicable only within the rated operating free-air temperature ranges of the various devices. An 18-pF compensation capacitor is used.



TYPICAL CHARACTERISTICS

EQUIVALENT INPUT NOISE VOLTAGE
 vs
 FREQUENCY

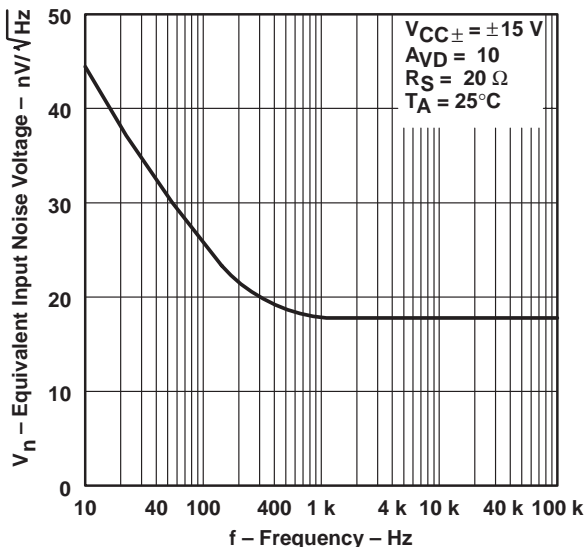

Figure 21

TOTAL HARMONIC DISTORTION
 vs
 FREQUENCY

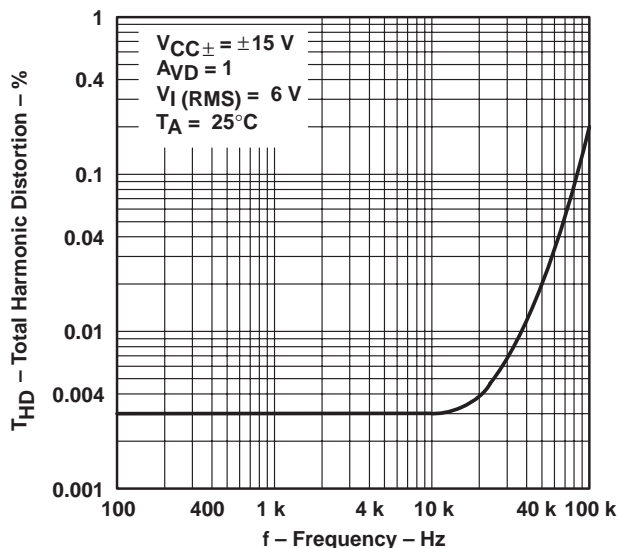

Figure 22

VOLTAGE-FOLLOWER
 LARGE-SIGNAL PULSE RESPONSE

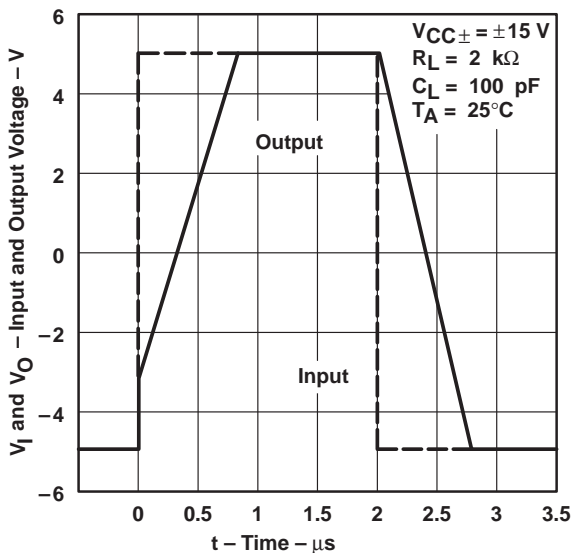

Figure 23

OUTPUT VOLTAGE
 vs
 ELAPSED TIME

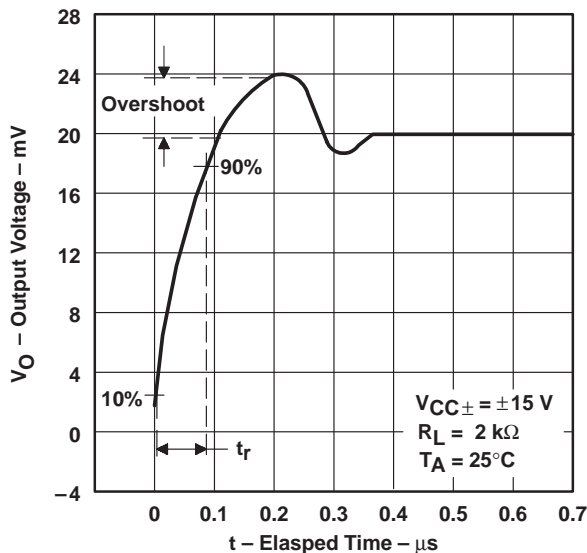

Figure 24

TL070
JFET-INPUT
OPERATIONAL AMPLIFIER

SLOS121A – NOVEMBER 1993 – REVISED AUGUST 1994

APPLICATION INFORMATION

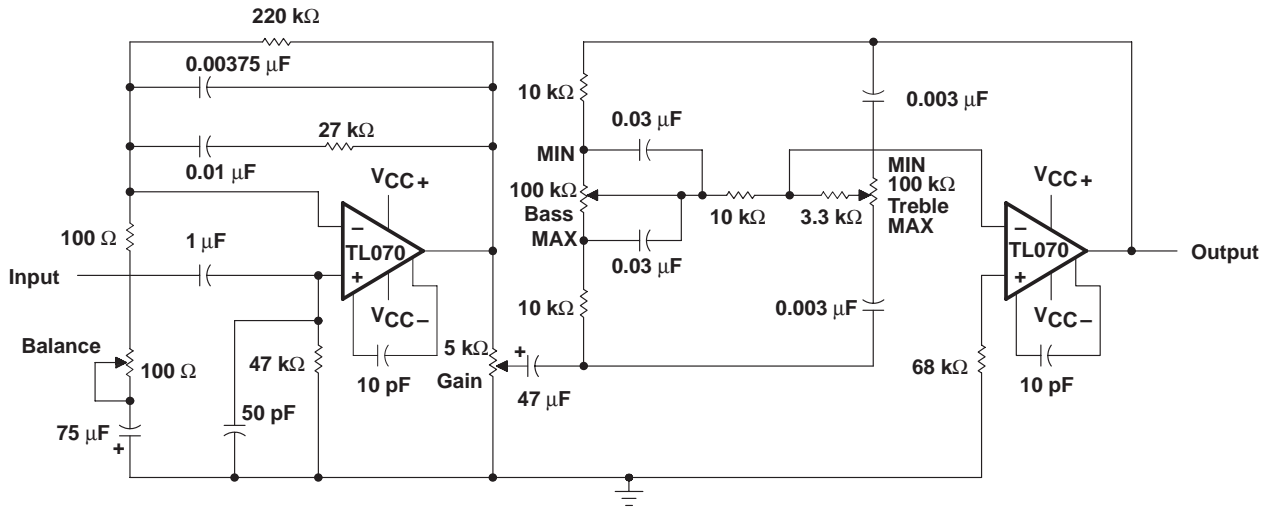

Figure 25. IC Preamplifier

IC PREAMPLIFIER
RESPONSE CHARACTERISTICS

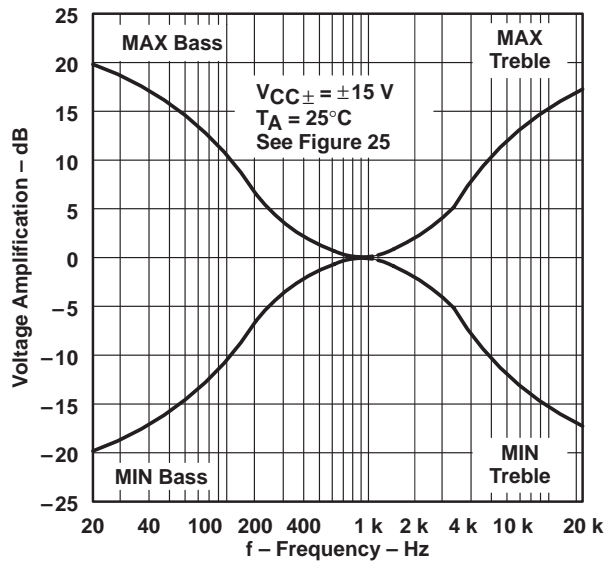

Figure 26

IMPORTANT NOTICE

Texas Instruments and its subsidiaries (TI) reserve the right to make changes to their products or to discontinue any product or service without notice, and advise customers to obtain the latest version of relevant information to verify, before placing orders, that information being relied on is current and complete. All products are sold subject to the terms and conditions of sale supplied at the time of order acknowledgement, including those pertaining to warranty, patent infringement, and limitation of liability.

TI warrants performance of its semiconductor products to the specifications applicable at the time of sale in accordance with TI's standard warranty. Testing and other quality control techniques are utilized to the extent TI deems necessary to support this warranty. Specific testing of all parameters of each device is not necessarily performed, except those mandated by government requirements.

CERTAIN APPLICATIONS USING SEMICONDUCTOR PRODUCTS MAY INVOLVE POTENTIAL RISKS OF DEATH, PERSONAL INJURY, OR SEVERE PROPERTY OR ENVIRONMENTAL DAMAGE ("CRITICAL APPLICATIONS"). TI SEMICONDUCTOR PRODUCTS ARE NOT DESIGNED, AUTHORIZED, OR WARRANTED TO BE SUITABLE FOR USE IN LIFE-SUPPORT DEVICES OR SYSTEMS OR OTHER CRITICAL APPLICATIONS. INCLUSION OF TI PRODUCTS IN SUCH APPLICATIONS IS UNDERSTOOD TO BE FULLY AT THE CUSTOMER'S RISK.

In order to minimize risks associated with the customer's applications, adequate design and operating safeguards must be provided by the customer to minimize inherent or procedural hazards.

TI assumes no liability for applications assistance or customer product design. TI does not warrant or represent that any license, either express or implied, is granted under any patent right, copyright, mask work right, or other intellectual property right of TI covering or relating to any combination, machine, or process in which such semiconductor products or services might be or are used. TI's publication of information regarding any third party's products or services does not constitute TI's approval, warranty or endorsement thereof.