

TLV1391 SINGLE DIFFERENTIAL COMPARATORS

SLCS128B – APRIL 1996 – REVISED JUNE 1999

- **Low-Voltage and Single-Supply Operation**
 $V_{CC} = 2\text{ V to }7\text{ V}$
- **Common-Mode Voltage Range Includes Ground**
- **Fast Response Time . . . 0.7 μs Typ**
- **Low Supply Current . . . 80 μA Typ and 150 μA Max**
- **Fully Specified at 3-V and 5-V Supply Voltages**
- **Available in SOT-23 (DBV) Packaging**

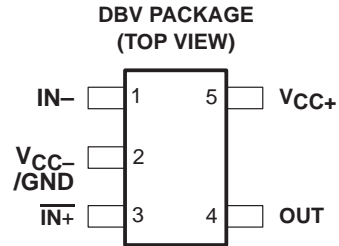

description

The TLV1391 is a differential comparator built using a Texas Instruments low-voltage, high-speed bipolar process. These devices have been developed specifically for low-voltage, single-supply applications. Their enhanced performance makes them excellent replacements for the LM393 in the improved 3-V and 5-V system designs of today.

The TLV1391, with its typical supply current of only 80 μA , is ideal for low-power systems. Response time also has been improved to 0.7 μs .

The TLV1391C is characterized for operation from 0°C to 70°C and the TLV1391I is characterized for operation from -40°C to 85°C.

AVAILABLE OPTIONS

T_A	PACKAGED DEVICES	SYMBOL	CHIP FORM (Y)
	SOT-23 (DBV)		
0°C to 70°C	TLV1391CDBV	VABC	TLV1391Y
-40°C to 85°C	TLV1391IDBV	VABI	

† The DBV package is only available taped and reeled. Chip forms are specified for operation at 25°C only.

symbol (each comparator)

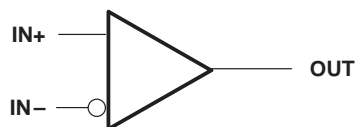

Please be aware that an important notice concerning availability, standard warranty, and use in critical applications of Texas Instruments semiconductor products and disclaimers thereto appears at the end of this data sheet.

PRODUCTION DATA information is current as of publication date. Products conform to specifications per the terms of Texas Instruments standard warranty. Production processing does not necessarily include testing of all parameters.

 **TEXAS
INSTRUMENTS**

POST OFFICE BOX 655303 • DALLAS, TEXAS 75265

Copyright © 1999, Texas Instruments Incorporated

TLV1391 SINGLE DIFFERENTIAL COMPARATORS

SLCS128B – APRIL 1996 – REVISED JUNE 1999

TLV1391, TLV1391Y equivalent schematic

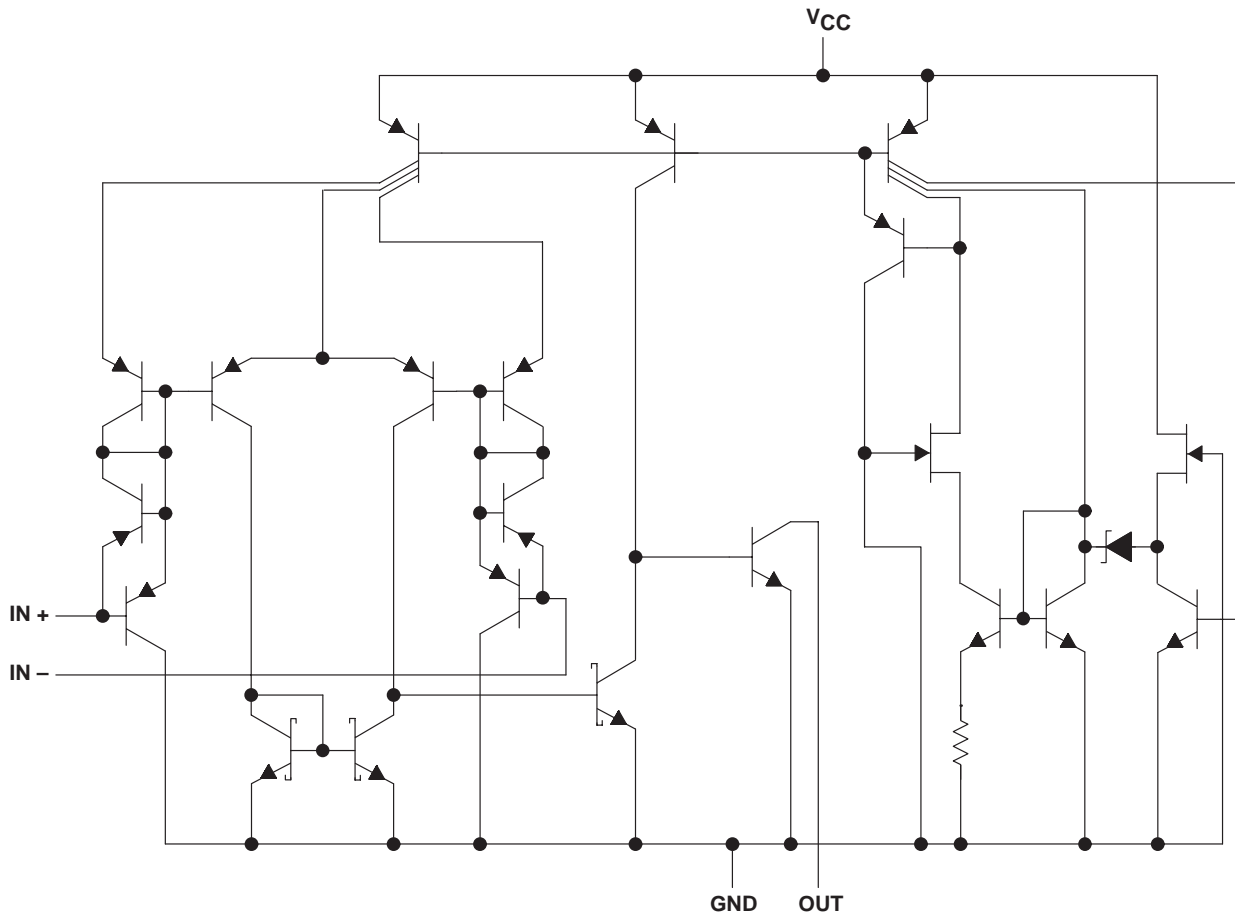

COMPONENT COUNT	
Transistors	26
Resistors	1
Diodes	4
Epi-FET	1

TLV1391 SINGLE DIFFERENTIAL COMPARATORS

SLCS128B – APRIL 1996 – REVISED JUNE 1999

absolute maximum ratings over operating free-air temperature range (unless otherwise noted)†

Supply voltage, V_{CC} (see Note 1)	7 V
Differential input voltage, V_{ID} (see Note 2)	± 7 V
Input voltage, V_I (any input)	–0.3 V to V_{CC}
Output voltage, V_O	7 V
Output current, I_O (each output)	20 mA
Duration of short-circuit current to GND (see Note 3)	Unlimited
Package thermal impedance, θ_{JA} (see Note 4 and 5)	347°C/W
Lead temperature 1,6 mm (1/16 inch) from case for 10 seconds	260°C
Storage temperature range, T_{Stg}	–65°C to 150°C

† Stresses beyond those listed under “absolute maximum ratings” may cause permanent damage to the device. These are stress ratings only, and functional operation of the device at these or any other conditions beyond those indicated under “recommended operating conditions” is not implied. Exposure to absolute-maximum-rated conditions for extended periods may affect device reliability.

- NOTES:
1. All voltage values, except differential voltages, are with respect to the network GND.
 2. Differential voltages are at the noninverting input with respect to the inverting input.
 3. Short circuits from the outputs to V_{CC} can cause excessive heating and eventual destruction of the chip.
 4. Maximum power dissipation is a function of $T_J(\text{max})$, θ_{JA} , and T_A . The maximum allowable power dissipation at any allowable ambient temperature is $P_D = (T_J(\text{max}) - T_A) / \theta_{JA}$. Operating at the absolute maximum T_J of 150°C can impact reliability.
 5. The package thermal impedance is calculated in accordance with JESD 51.

recommended operating conditions

		MIN	MAX	UNIT
Supply voltage, V_{CC}		2	7	V
Operating free-air temperature, T_A	TLV1391C	0	70	°C
	TLV1391I	–40	85	



TLV1391

SINGLE DIFFERENTIAL COMPARATORS

SLCS128B – APRIL 1996 – REVISED JUNE 1999

electrical characteristics, $V_{CC} = 3\text{ V}$

PARAMETER	TEST CONDITIONS	T_A †	TLV1391C			UNIT
			MIN	TYP	MAX	
V_{IO} Input offset voltage	$V_O = 1.4\text{ V}$, $V_{IC} = V_{ICR}(\text{min})$	25°C		1.5	5	mV
		Full range			9	
V_{ICR} Common-mode input voltage range		25°C	0 to $V_{CC} - 1.5$	0 to $V_{CC} - 1.2$		V
		Full range	0 to $V_{CC} - 2$			
V_{OL} Low-level output voltage	$V_{ID} = -1\text{ V}$, $I_{OL} = 500\text{ }\mu\text{A}$	Full range		120	300	mV
I_{IO} Input offset current	$V_O = 1.4\text{ V}$	25°C		5	50	nA
		Full range			150	
I_{IB} Input bias current	$V_O = 1.4\text{ V}$	25°C		-40	-250	nA
		Full range			-400	
I_{OH} High-level output current	$V_{ID} = 1\text{ V}$, $V_{OH} = 3\text{ V}$	25°C		0.1		nA
	$V_{ID} = 1\text{ V}$, $V_{OH} = 5\text{ V}$	Full range			100	
I_{OL} Low-level output current	$V_{ID} = -1\text{ V}$, $V_{OL} = 1.5\text{ V}$	25°C	500			μA
$I_{CC(H)}$ High-level supply current	$V_O = V_{OH}$	25°C		80	125	μA
		Full range			150	
$I_{CC(L)}$ Low-level supply current	$V_O = V_{OL}$	25°C		80	125	μA
		Full range			150	

† Full range is 0°C to 70°C.

switching characteristics, $V_{CC} = 3\text{ V}$, $C_L = 15\text{ pF}$ ‡, $T_A = 25^\circ\text{C}$

PARAMETER	TEST CONDITIONS	TLV1391C			UNIT
		MIN	TYP	MAX	
Response time	100-mV input step with 5-mV overdrive, $R_L = 5.1\text{ k}\Omega$		0.7		μs

‡ C_L includes the probe and jig capacitance.



TLV1391 SINGLE DIFFERENTIAL COMPARATORS

SLCS128B – APRIL 1996 – REVISED JUNE 1999

electrical characteristics, $V_{CC} = 5\text{ V}$

PARAMETER	TEST CONDITIONS	T_A †	TLV1391C			UNIT
			MIN	TYP	MAX	
V_{IO} Input offset voltage	$V_O = 1.4\text{ V}$, $V_{IC} = V_{ICR}(\text{min})$	25°C		1.5	5	mV
		Full range			9	
V_{ICR} Common-mode input voltage range		25°C	0 to $V_{CC} - 1.5$	0 to $V_{CC} - 1.2$		V
		Full range	0 to $V_{CC} - 2$			
V_{OL} Low-level output voltage	$V_{ID} = -1\text{ V}$, $I_{OL} = 500\text{ }\mu\text{A}$	Full range		120	300	mV
I_{IO} Input offset current	$V_O = 1.4\text{ V}$	25°C		5	50	nA
		Full range			150	
I_{IB} Input bias current	$V_O = 1.4\text{ V}$	25°C		-40	-250	nA
		Full range			-400	
I_{OH} High-level output current	$V_{ID} = 1\text{ V}$, $V_{OH} = 3\text{ V}$	25°C		0.1		nA
	$V_{ID} = 1\text{ V}$, $V_{OH} = 5\text{ V}$	Full range			100	
I_{OL} Low-level output current	$V_{ID} = -1\text{ V}$, $V_{OL} = 1.5\text{ V}$	25°C	600			μA
$I_{CC(H)}$ High-level supply current	$V_O = V_{OH}$	25°C		100	150	μA
		Full range			175	
$I_{CC(L)}$ Low-level supply current	$V_O = V_{OL}$	25°C		100	150	μA
		Full range			175	

† Full range is 0°C to 70°C.

switching characteristics, $V_{CC} = 5\text{ V}$, $C_L = 15\text{ pF}$ ‡, $T_A = 25^\circ\text{C}$

PARAMETER	TEST CONDITIONS	TLV1391C			UNIT
		MIN	TYP	MAX	
Response time	100-mV input step with 5-mV overdrive, $R_L = 5.1\text{ k}\Omega$		0.65		μs
	TTL-level input step, $R_L = 5.1\text{ k}\Omega$		0.18		

‡ C_L includes the probe and jig capacitance.

TLV1391

SINGLE DIFFERENTIAL COMPARATORS

SLCS128B – APRIL 1996 – REVISED JUNE 1999

electrical characteristics, $V_{CC} = 3\text{ V}$

PARAMETER	TEST CONDITIONS	T_A †	TLV1391I			UNIT
			MIN	TYP	MAX	
V_{IO} Input offset voltage	$V_O = 1.4\text{ V}$, $V_{IC} = V_{ICR}(\text{min})$	25°C		1.5	5	mV
		Full range			9	
V_{ICR} Common-mode input voltage range		25°C	0 to $V_{CC} - 1.5$	0 to $V_{CC} - 1.2$		V
		Full range	0 to $V_{CC} - 2$			
V_{OL} Low-level output voltage	$V_{ID} = -1\text{ V}$, $I_{OL} = 500\text{ }\mu\text{A}$	Full range		120	300	mV
I_{IO} Input offset current	$V_O = 1.4\text{ V}$	25°C		5	50	nA
		Full range			150	
I_{IB} Input bias current	$V_O = 1.4\text{ V}$	25°C		-40	-250	nA
		Full range			-400	
I_{OH} High-level output current	$V_{ID} = 1\text{ V}$, $V_{OH} = 3\text{ V}$	25°C		0.1		nA
	$V_{ID} = 1\text{ V}$, $V_{OH} = 5\text{ V}$	Full range			100	
I_{OL} Low-level output current	$V_{ID} = -1\text{ V}$, $V_{OL} = 1.5\text{ V}$	25°C	500			μA
$I_{CC(H)}$ High-level supply current	$V_O = V_{OH}$	25°C		80	125	μA
		Full range			150	
$I_{CC(L)}$ Low-level supply current	$V_O = V_{OL}$	25°C		80	125	μA
		Full range			150	

† Full range is -40°C to 85°C .

switching characteristics, $V_{CC} = 3\text{ V}$, $C_L = 15\text{ pF}$ ‡, $T_A = 25^\circ\text{C}$

PARAMETER	TEST CONDITIONS	TLV1391I			UNIT
		MIN	TYP	MAX	
Response time	100-mV input step with 5-mV overdrive, $R_L = 5.1\text{ k}\Omega$		0.7		μs

‡ C_L includes the probe and jig capacitance.



TLV1391 SINGLE DIFFERENTIAL COMPARATORS

SLCS128B – APRIL 1996 – REVISED JUNE 1999

electrical characteristics, $V_{CC} = 5\text{ V}$

PARAMETER	TEST CONDITIONS	T_A †	TLV1391I			UNIT
			MIN	TYP	MAX	
V_{IO} Input offset voltage	$V_O = 1.4\text{ V}$, $V_{IC} = V_{ICR}(\text{min})$	25°C		1.5	5	mV
		Full range			9	
V_{ICR} Common-mode input voltage range		25°C	0 to $V_{CC} - 1.5$	0 to $V_{CC} - 1.2$		V
		Full range	0 to $V_{CC} - 2$			
V_{OL} Low-level output voltage	$V_{ID} = -1\text{ V}$, $I_{OL} = 500\text{ }\mu\text{A}$	Full range		120	300	mV
I_{IO} Input offset current	$V_O = 1.4\text{ V}$	25°C		5	50	nA
		Full range			150	
I_{IB} Input bias current	$V_O = 1.4\text{ V}$	25°C		-40	-250	nA
		Full range			-400	
I_{OH} High-level output current	$V_{ID} = 1\text{ V}$, $V_{OH} = 3\text{ V}$	25°C		0.1		nA
	$V_{ID} = 1\text{ V}$, $V_{OH} = 5\text{ V}$	Full range			100	
I_{OL} Low-level output current	$V_{ID} = -1\text{ V}$, $V_{OL} = 1.5\text{ V}$	25°C	600			μA
$I_{CC(H)}$ High-level supply current	$V_O = V_{OH}$	25°C		100	150	μA
		Full range			175	
$I_{CC(L)}$ Low-level supply current	$V_O = V_{OL}$	25°C		100	150	μA
		Full range			175	

† Full range is -40°C to 85°C .

switching characteristics, $V_{CC} = 5\text{ V}$, $C_L = 15\text{ pF}$ ‡, $T_A = 25^\circ\text{C}$

PARAMETER	TEST CONDITIONS	TLV1391I			UNIT
		MIN	TYP	MAX	
Response time	100-mV input step with 5-mV overdrive, $R_L = 5.1\text{ k}\Omega$		0.65		μs
	TTL-level input step, $R_L = 5.1\text{ k}\Omega$		0.18		

‡ C_L includes the probe and jig capacitance.



TLV1391

SINGLE DIFFERENTIAL COMPARATORS

SLCS128B – APRIL 1996 – REVISED JUNE 1999

electrical characteristics, $V_{CC} = 3\text{ V}$, $T_A = 25^\circ\text{C}$

PARAMETER	TEST CONDITIONS	TLV1391Y			UNIT
		MIN	TYP	MAX	
V_{IO} Input offset voltage	$V_O = 1.4\text{ V}$, $V_{IC} = V_{ICR}(\text{min})$		1.5	5	mV
V_{ICR} Common-mode input voltage range		0 to $V_{CC} - 1.5$	0 to $V_{CC} - 1.2$		V
I_{IO} Input offset current	$V_O = 1.4\text{ V}$		5	50	nA
I_{IB} Input bias current	$V_O = 1.4\text{ V}$		-40	-250	nA
I_{OH} High-level output current	$V_{ID} = 1\text{ V}$, $V_{OH} = 3\text{ V}$		0.1		nA
I_{OL} Low-level output current	$V_{ID} = -1\text{ V}$, $V_{OL} = 1.5\text{ V}$	500			μA
$I_{CC(H)}$ High-level supply current	$V_O = V_{OH}$		80	125	μA
$I_{CC(L)}$ Low-level supply current	$V_O = V_{OL}$		80	125	μA

switching characteristics, $V_{CC} = 3\text{ V}$, $C_L = 15\text{ pF}^\dagger$, $T_A = 25^\circ\text{C}$

PARAMETER	TEST CONDITIONS	TLV1391Y			UNIT
		MIN	TYP	MAX	
Response time	100-mV input step with 5-mV overdrive, $R_L = 5.1\text{ k}\Omega$		0.7		μs

$^\dagger C_L$ includes the probe and jig capacitance.

electrical characteristics, $V_{CC} = 5\text{ V}$, $T_A = 25^\circ\text{C}$

PARAMETER	TEST CONDITIONS	TLV1391Y			UNIT
		MIN	TYP	MAX	
V_{IO} Input offset voltage	$V_O = 1.4\text{ V}$, $V_{IC} = V_{ICR}(\text{min})$		1.5	5	mV
V_{ICR} Common-mode input voltage range		0 to $V_{CC} - 1.5$	0 to $V_{CC} - 1.2$		V
I_{IO} Input offset current	$V_O = 1.4\text{ V}$		5	50	nA
I_{IB} Input bias current	$V_O = 1.4\text{ V}$		-40	-250	nA
I_{OH} High-level output current	$V_{ID} = 1\text{ V}$, $V_{OH} = 3\text{ V}$		0.1		nA
I_{OL} Low-level output current	$V_{ID} = -1\text{ V}$, $V_{OL} = 1.5\text{ V}$	600			μA
$I_{CC(H)}$ High-level supply current	$V_O = V_{OH}$		100	150	μA
$I_{CC(L)}$ Low-level supply current	$V_O = V_{OL}$		100	150	μA

switching characteristics, $V_{CC} = 5\text{ V}$, $C_L = 15\text{ pF}^\ddagger$, $T_A = 25^\circ\text{C}$

PARAMETER	TEST CONDITIONS	TLV1391Y			UNIT
		MIN	TYP	MAX	
Response time	100-mV input step with 5-mV overdrive, $R_L = 5.1\text{ k}\Omega$		0.65		μs
	TTL-level input step, $R_L = 5.1\text{ k}\Omega$		0.18		

$^\ddagger C_L$ includes the probe and jig capacitance.



TYPICAL CHARACTERISTICS

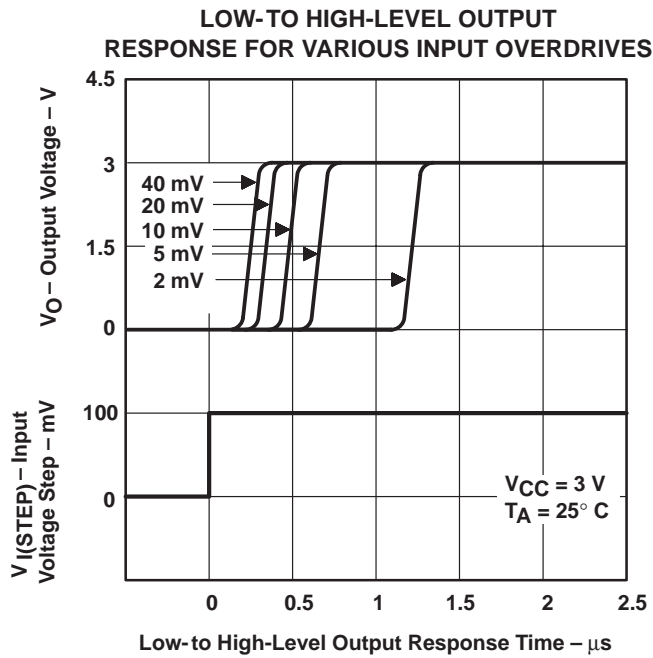

Figure 1

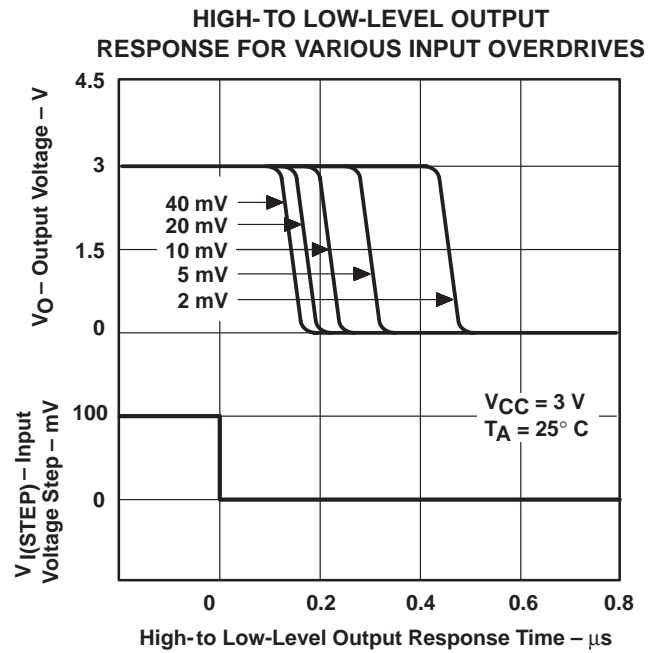

Figure 2

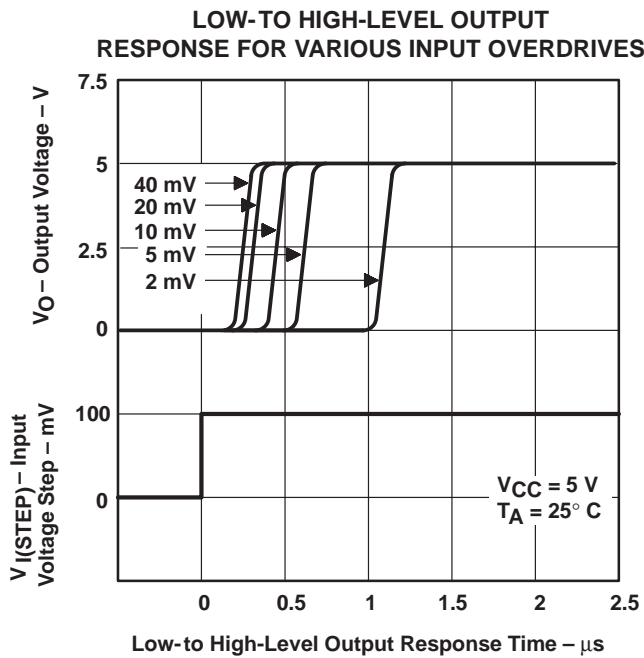

Figure 3

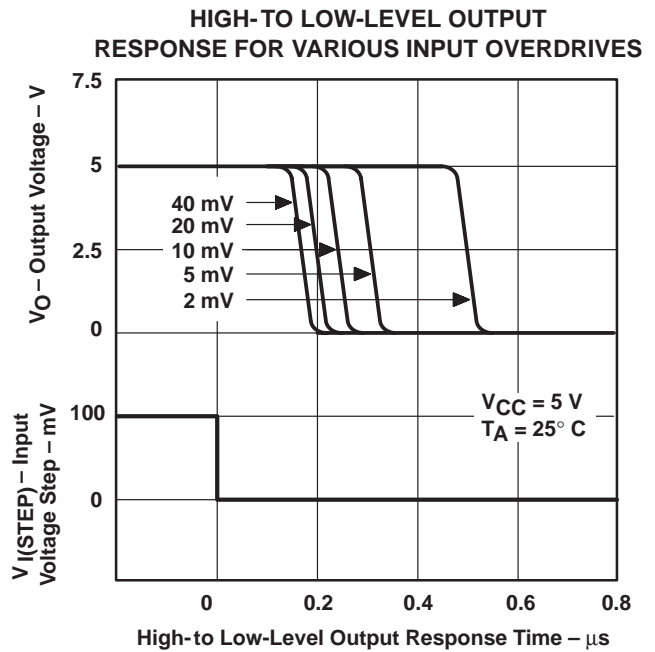

Figure 4

IMPORTANT NOTICE

Texas Instruments and its subsidiaries (TI) reserve the right to make changes to their products or to discontinue any product or service without notice, and advise customers to obtain the latest version of relevant information to verify, before placing orders, that information being relied on is current and complete. All products are sold subject to the terms and conditions of sale supplied at the time of order acknowledgement, including those pertaining to warranty, patent infringement, and limitation of liability.

TI warrants performance of its semiconductor products to the specifications applicable at the time of sale in accordance with TI's standard warranty. Testing and other quality control techniques are utilized to the extent TI deems necessary to support this warranty. Specific testing of all parameters of each device is not necessarily performed, except those mandated by government requirements.

CERTAIN APPLICATIONS USING SEMICONDUCTOR PRODUCTS MAY INVOLVE POTENTIAL RISKS OF DEATH, PERSONAL INJURY, OR SEVERE PROPERTY OR ENVIRONMENTAL DAMAGE ("CRITICAL APPLICATIONS"). TI SEMICONDUCTOR PRODUCTS ARE NOT DESIGNED, AUTHORIZED, OR WARRANTED TO BE SUITABLE FOR USE IN LIFE-SUPPORT DEVICES OR SYSTEMS OR OTHER CRITICAL APPLICATIONS. INCLUSION OF TI PRODUCTS IN SUCH APPLICATIONS IS UNDERSTOOD TO BE FULLY AT THE CUSTOMER'S RISK.

In order to minimize risks associated with the customer's applications, adequate design and operating safeguards must be provided by the customer to minimize inherent or procedural hazards.

TI assumes no liability for applications assistance or customer product design. TI does not warrant or represent that any license, either express or implied, is granted under any patent right, copyright, mask work right, or other intellectual property right of TI covering or relating to any combination, machine, or process in which such semiconductor products or services might be or are used. TI's publication of information regarding any third party's products or services does not constitute TI's approval, warranty or endorsement thereof.