

## 10-A, 4.5-V to 14-V INPUT, NON-ISOLATED POWER MODULE FOR 3-GHz DSP SYSTEMS

### FEATURES

- Up to 10-A Output Current
- 4.5-V to 14-V Input Voltage
- Wide-Output Voltage Adjust (0.69 V to 2.0 V)
- $\pm 1.5\%$  Total Output Voltage Variation
- Efficiencies up to 92%
- Output Overcurrent Protection (Nonlatching, Auto-Reset)
- Operating Temperature:  $-40^{\circ}\text{C}$  to  $85^{\circ}\text{C}$
- Safety Agency Approvals:
  - UL/IEC/CSA-C22.2 60950-1
- Prebias Startup
- On/Off Inhibit
- Differential Output Voltage Remote Sense
- Adjustable Undervoltage Lockout
- Auto-Track™ Sequencing
- SmartSync Technology

- TurboTrans™ Technology
- Designed to meet Ultra-Fast Transient Requirements for 3-GHz DSP Systems
- 15 mV Output Voltage Deviation ( $C_O = 3000 \mu\text{F}$ ,  $\Delta I = 5 \text{ A}$ )

### APPLICATIONS

- Wireless Infrastructure Base Stations



### DESCRIPTION

The PTH08T240F is a high-performance 10-A rated, non-isolated power module designed to meet ultra-fast transient requirements for 3-GHz DSP systems. This module represents the 2nd generation of the popular PTH series power modules which include a reduced footprint and additional features.

Operating from an input voltage range of 4.5 V to 14 V, the PTH08T240F requires a single resistor to set the output voltage to any value over the range, 0.69 V to 2.0 V. The output voltage range makes the PTH08T240F particularly suitable for the 3-GHz DSP's core voltage requirements between 0.9 V and 1.1 V. Additionally, the wide input voltage range increases design flexibility by supporting operation with 5-V, 8-V, or 12-V intermediate bus architectures.

The module incorporates a comprehensive list of features. Output over-current and over-temperature shutdown protects against most load faults. A differential remote sense ensures tight load regulation. An adjustable under-voltage lockout allows the turn-on voltage threshold to be customized. Auto-Track™ sequencing is a popular feature that greatly simplifies the simultaneous power-up and power-down of multiple modules in a power system.

The PTH08T240F includes new patent pending technologies, **TurboTrans™** and **SmartSync**. The TurboTrans feature optimizes the transient response of the regulator while simultaneously reducing the quantity of external output capacitors required to meet a target voltage deviation specification. TurboTrans allows PTH08T240F to meet the tight transient voltage tolerances required by 3-GHz DSPs with minimal output capacitance. SmartSync allows for switching frequency synchronization of multiple modules, thus simplifying EMI noise suppression tasks and reducing input capacitor RMS current requirements. The module uses double-sided surface mount construction to provide a low profile and compact footprint. Package options include both through-hole and surface mount configurations that are lead (Pb) - free and RoHS compatible.

PRODUCT PREVIEW



Please be aware that an important notice concerning availability, standard warranty, and use in critical applications of Texas Instruments semiconductor products and disclaimers thereto appears at the end of this data sheet.

Auto-Track, TMS320 are trademarks of Texas Instruments.



These devices have limited built-in ESD protection. The leads should be shorted together or the device placed in conductive foam during storage or handling to prevent electrostatic damage to the MOS gates.

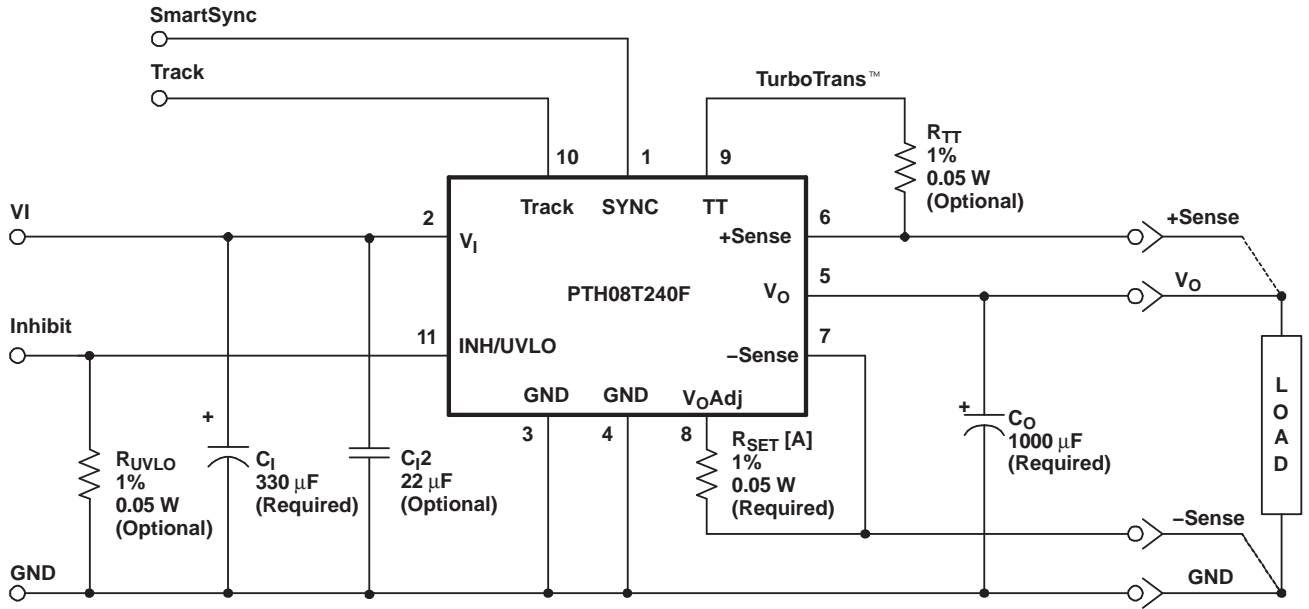

A.  $R_{SET}$  required to set the output voltage to a value higher than 0.69 V. See *Electrical Characteristics* table.

PRODUCT PREVIEW

**ORDERING INFORMATION**

For the most current package and ordering information, see the Package Option Addendum at the end of this datasheet, or see the TI website at [www.ti.com](http://www.ti.com).

**DATASHEET TABLE OF CONTENTS**

DATASHEET SECTION	PAGE NUMBER
ENVIRONMENTAL AND ABSOLUTE MAXIMUM RATINGS	3
ELECTRICAL CHARACTERISTICS TABLE	4
TERMINAL FUNCTIONS	6
TYPICAL CHARACTERISTICS ( $V_I = 12V$ )	7
TYPICAL CHARACTERISTICS ( $V_I = 5V$ )	8
ADJUSTING THE OUTPUT VOLTAGE	9
INPUT & OUTPUT CAPACITOR RECOMMENDATIONS	11
TURBOTRANS™ INFORMATION	15
UNDERVOLTAGE LOCKOUT (UVLO)	20
SOFT-START POWER-UP	21
OUTPUT INHIBIT	22
OVER-CURRENT PROTECTION	23
OVER-TEMPERATURE PROTECTION	23
REMOTE SENSE	23
SYNCHRONIZATION (SMARTSYNC)	24
AUTO-TRACK SEQUENCING	25
PREBIAS START-UP	28
TAPE & REEL AND TRAY DRAWINGS	30

**ENVIRONMENTAL AND ABSOLUTE MAXIMUM RATINGS**

(Voltages are with respect to GND)

			UNIT	
$V_{Track}$	Track pin voltage		–0.3 to $V_I + 0.3$ V	
$T_A$	Operating temperature range	Over $V_I$ range	–40 to 85	
$T_{wave}$	Wave soldering temperature	Surface temperature of module body or pins for 5 seconds maximum.	suffix AH	235
			suffix AD	260
$T_{reflow}$	Solder reflow temperature	Surface temperature of module body or pins	suffix AS	235 <sup>(1)</sup>
			suffix AZ	260 <sup>(1)</sup>
$T_{stg}$	Storage temperature		–40 to 125 <sup>(2)</sup>	
	Mechanical shock	Per Mil-STD-883D, Method 2002.3 1 msec, 1/2 sine, mounted	suffix AH & AD	500
			suffix AS & AZ	250
	Mechanical vibration	Mil-STD-883D, Method 2007.2 20-2000 Hz	15	
	Weight		5	
	Flammability	Meets UL94V-O	grams	

- (1) During reflow of surface mount package version do not elevate peak temperature of the module, pins or internal components above the stated maximum.
- (2) The shipping tray or tape and reel cannot be used to bake parts at temperatures higher than 65°C.

**PRODUCT PREVIEW**

**ELECTRICAL CHARACTERISTICS**

**PTH08T240F**

$T_A = 25^\circ\text{C}$ ,  $V_I = 5\text{ V}$ ,  $V_O = 1.0\text{ V}$ ,  $C_I = 330\text{ }\mu\text{F}$ ,  $C_O = 1000\text{ }\mu\text{F}$ , and  $I_O = I_O\text{ max}$  (unless otherwise stated)

PARAMETER	TEST CONDITIONS	PTH08T240F			UNIT
		MIN	TYP	MAX	
$I_O$ Output current	Over $V_O$ range 25°C, natural convection	0		10	A
$V_I$ Input voltage range	Over $I_O$ range	$0.69 \leq V_O \leq 1.2$	4.5	$11 \times V_O^{(1)}$	V
		$1.2 < V_O \leq 2.0$	4.5	14	
$V_{O\text{ADJ}}$ Output voltage adjust range	Over $I_O$ range	0.69		2.0	V
$V_O$	Set-point voltage tolerance		$\pm 0.5$	$\pm 1^{(2)}$	$\%V_O$
	Temperature variation	$-40^\circ\text{C} < T_A < 85^\circ\text{C}$	$\pm 0.3$		$\%V_O$
	Line regulation	Over $V_I$ range	$\pm 3$		mV
	Load regulation	Over $I_O$ range	$\pm 2$		mV
	Total output variation	Includes set-point, line, load, $-40^\circ\text{C} \leq T_A \leq 85^\circ\text{C}$			$\pm 1.5^{(2)}$
$\eta$ Efficiency	$I_O = 10\text{ A}$	$R_{\text{SET}} = 4.78\text{ k}\Omega$ , $V_O = 1.8\text{ V}$		90%	
		$R_{\text{SET}} = 7.09\text{ k}\Omega$ , $V_O = 1.5\text{ V}$		88%	
		$R_{\text{SET}} = 12.1\text{ k}\Omega$ , $V_O = 1.2\text{ V}$		87%	
		$R_{\text{SET}} = 20.8\text{ k}\Omega$ , $V_O = 1.0\text{ V}$		85%	
$V_O$ Ripple (peak-to-peak)	20-MHz bandwidth		10 <sup>(3)</sup>		mV <sub>PP</sub>
$I_{\text{LIM}}$ Overcurrent threshold	Reset, followed by auto-recovery		20		A
$t_{\text{tr}}$ $\Delta V_{\text{tr}}$ $t_{\text{trTT}}$ $\Delta V_{\text{trTT}}$ Transient response	2.5 A/ $\mu\text{s}$ load step 50 to 100% $I_{O\text{max}}$ $V_O = 2.5\text{ V}$	w/o TurboTrans $C_O = 1000\text{ }\mu\text{F}$ , Type C	Recovery time	tbd	$\mu\text{s}$
		w/ TurboTrans $C_O = \text{tbd }\mu\text{F}$ , Type C, $R_{\text{TT}} = \text{tbd }\Omega$	$V_O$ over/undershoot	tbd	mV
			Recovery time	tbd	$\mu\text{s}$
		$V_O$ over/undershoot	tbd	mV	
$I_{\text{IL}}$ Track input current (pin 10)	Pin to GND			-130 <sup>(4)</sup>	$\mu\text{A}$
$dV_{\text{track}}/dt$ Track slew rate capability	$C_O \leq C_{O\text{max}}$			1	V/ms
$UVLO_{\text{ADJ}}$ Adjustable Under-voltage lockout (pin 11)	$V_I$ increasing, $R_{\text{UVLO}} = \text{OPEN}$		4.3	4.45	V
	$V_I$ decreasing, $R_{\text{UVLO}} = \text{OPEN}$		4.0	4.2	
	Hysteresis, $R_{\text{UVLO}} \leq 52.3\text{ k}\Omega$		0.5		
Inhibit control (pin 11)	Input high voltage ( $V_{\text{IH}}$ )			Open <sup>(5)</sup>	V
	Input low voltage ( $V_{\text{IL}}$ )		-0.2	0.8	
	Input low current ( $I_{\text{IL}}$ ), Pin 11 to GND			-235	
$I_{\text{in}}$ Input standby current	Inhibit (pin 11) to GND, Track (pin 10) open		5		mA
$f_s$ Switching frequency	Over $V_I$ and $I_O$ ranges, SmartSync (pin 1) to GND	260	300	340	kHz
$f_{\text{SYNC}}$ Synchronization (SYNC) frequency		240		400	kHz
$V_{\text{SYNCH}}$ SYNC High-Level Input Voltage		2		5.5	V
$V_{\text{SYNCL}}$ SYNC Low-Level Input Voltage				0.8	V
$t_{\text{SYNC}}$ SYNC Minimum Pulse Width		200			nSec
$C_I$ External input capacitance	Nonceramic	330 <sup>(6)</sup>			$\mu\text{F}$
	Ceramic		22 <sup>(6)</sup>		

- (1) The maximum input voltage is duty cycle limited to ( $V_O \times 11$ ) or 14 volts, whichever is less. The maximum allowable input voltage is a function of switching frequency, and may increase or decrease when the SmartSync feature is utilized. Please review the SmartSync section of the Application Information for further guidance.
- (2) The set-point voltage tolerance is affected by the tolerance and stability of  $R_{\text{SET}}$ . The stated limit is unconditionally met if  $R_{\text{SET}}$  has a tolerance of 1% with 100 ppm/°C or better temperature stability.
- (3) For output voltages less than 1.7 V, the ripple may increase (up to 2x) when operating at input voltages greater than ( $V_O \times 11$ ). See the SmartSync section of the Application Information for input voltage and frequency limitations.
- (4) A low-leakage (<100 nA), open-drain device, such as MOSFET or voltage supervisor IC, is recommended to control pin 10. The open-circuit voltage is less than 8  $V_{\text{dc}}$ .
- (5) This control pin has an internal pull-up. Do not place an external pull-up on this pin. If it is left open-circuit, the module operates when input power is applied. A small, low-leakage (<100 nA) MOSFET is recommended for control. For additional information, see the related application information section.
- (6) A 330  $\mu\text{F}$  electrolytic input capacitor is required for proper operation. The electrolytic capacitor must be rated for a minimum of 500 mA rms of ripple current.

**ELECTRICAL CHARACTERISTICS (continued)**

**PTH08T240F**

$T_A = 25^\circ\text{C}$ ,  $V_I = 5\text{ V}$ ,  $V_O = 1.0\text{ V}$ ,  $C_I = 330\ \mu\text{F}$ ,  $C_O = 1000\ \mu\text{F}$ , and  $I_O = I_O\ \text{max}$  (unless otherwise stated)

PARAMETER		TEST CONDITIONS		PTH08T240F			UNIT
				MIN	TYP	MAX	
$C_O$	External output capacitance	w/o TurboTrans	Capacitance Value	1000 <sup>(7)</sup>		5000 <sup>(8)</sup>	$\mu\text{F}$
						500	
			Equivalent series resistance (non-ceramic)	7			$\text{m}\Omega$
		w/ TurboTrans	Capacitance Value	see table <sup>(7)(9)</sup>			$\mu\text{F}$
		Capacitance $\times$ ESR product ( $C_O \times \text{ESR}$ )	1000	10000 <sup>(9)</sup>		$\mu\text{F} \times \text{m}\Omega$	
MTBF	Reliability	Per Telcordia SR-332, 50% stress, $T_A = 40^\circ\text{C}$ , ground benign		6.1			$10^6\ \text{Hr}$

- (7) 1000  $\mu\text{F}$  of external output capacitance is required for basic operation. The minimum output capacitance requirement increases when *TurboTrans™* (TT) technology is utilized. See related Application Information for more guidance.
- (8) This is the calculated maximum disregarding *TurboTrans™* technology. When the *TurboTrans™* feature is utilized, the minimum output capacitance must be increased.
- (9) When using *TurboTrans™* technology, a minimum value of output capacitance is required for proper operation. Additionally, low ESR capacitors are required for proper operation. See the application notes for further guidance.

TERMINAL FUNCTIONS

TERMINAL		DESCRIPTION
NAME	NO.	
$V_I$	2	The positive input voltage power node to the module, which is referenced to common GND.
$V_O$	5	The regulated positive power output with respect to GND.
GND	3, 4	This is the common ground connection for the $V_I$ and $V_O$ power connections. It is also the 0 $V_{dc}$ reference for the control inputs.
Inhibit <sup>(1)</sup> and UVLO	11	The Inhibit pin is an open-collector/drain, negative logic input that is referenced to GND. Applying a low level ground signal to this input disables the module's output and turns off the output voltage. When the Inhibit control is active, the input current drawn by the regulator is significantly reduced. If the Inhibit pin is left open-circuit, the module produces an output whenever a valid input source is applied.  This pin is also used for input undervoltage lockout (UVLO) programming. Connecting a resistor from this pin to GND (pin 3) allows the ON threshold of the UVLO to be adjusted higher than the default value. For more information, see the Application Information section.
$V_O$ Adjust	8	A 0.05 W 1% resistor must be directly connected between this pin and pin 7 (–Sense) to set the output voltage to a value higher than 0.69 V. The temperature stability of the resistor should be 100 ppm/°C (or better). The setpoint range for the output voltage is from 0.69 V to 2.0 V. If left open circuit, the output voltage will default to its lowest value. For further information, on output voltage adjustment see the related application note.  The specification table gives the preferred resistor values for a number of standard output voltages.
+ Sense	6	The sense input allows the regulation circuit to compensate for voltage drop between the module and the load. For optimal voltage accuracy, +Sense must be connected to $V_O$ , very close to the load.
– Sense	7	The sense input allows the regulation circuit to compensate for voltage drop between the module and the load. For optimal voltage accuracy –Sense must be connected to GND (pin 4) very close to the module (within 10 cm).
Track	10	This is an analog control input that enables the output voltage to follow an external voltage. This pin becomes active typically 20 ms after the input voltage has been applied, and allows direct control of the output voltage from 0 V up to the nominal set-point voltage. Within this range the module's output voltage follows the voltage at the Track pin on a volt-for-volt basis. When the control voltage is raised above this range, the module regulates at its set-point voltage. The feature allows the output voltage to rise simultaneously with other modules powered from the same input bus. If unused, this input should be connected to $V_I$ .  NOTE: Due to the undervoltage lockout feature, the output of the module cannot follow its own input voltage during power up. For more information, see the related application note.
TurboTrans™	9	This input pin adjusts the transient response of the regulator. To activate the TurboTrans™ feature, a 1%, 50 mW resistor must be connected between this pin and pin 6 (+Sense) very close to the module. For a given value of output capacitance, a reduction in peak output voltage deviation is achieved by utilizing this feature. If unused, this pin must be left open-circuit. The resistance requirement can be selected from the TurboTrans™ resistor table in the Application Information section. External capacitance must never be connected to this pin unless the TurboTrans resistor value is a short, 0Ω.
SmartSync	1	This input pin synchronizes the switching frequency of the module to an external clock frequency. The SmartSync feature can be used to synchronize the switching frequency of multiple PTH08T240F modules, aiding EMI noise suppression efforts. If unused, this pin should be connected to GND (pin 3). For more information, please review the Application Information section.

(1) Denotes negative logic: Open = Normal operation, Ground = Function active

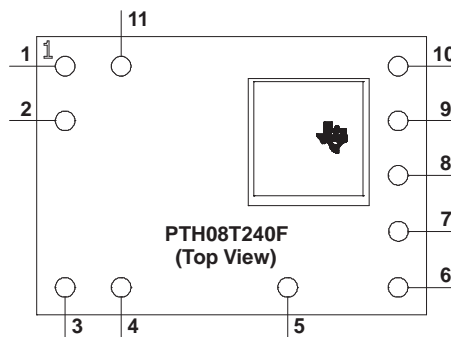

TYPICAL CHARACTERISTICS<sup>(1)(2)</sup>

CHARACTERISTIC DATA ( $V_I = 12\text{ V}$ )

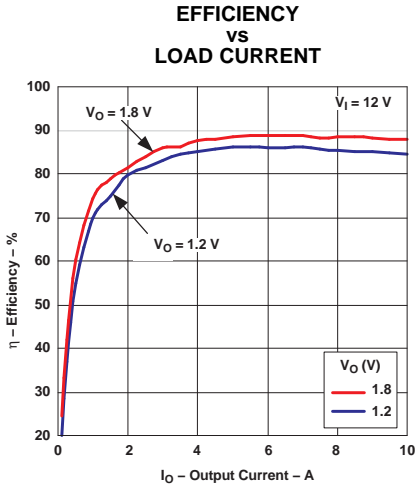

Figure 1.

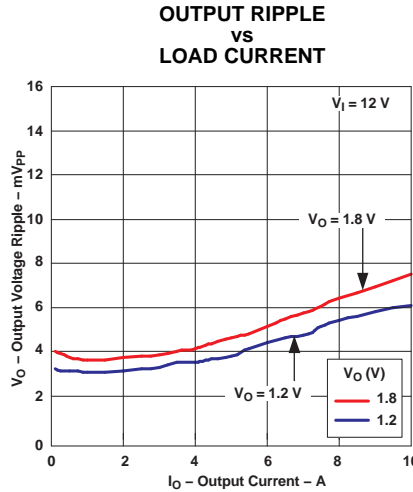

Figure 2.

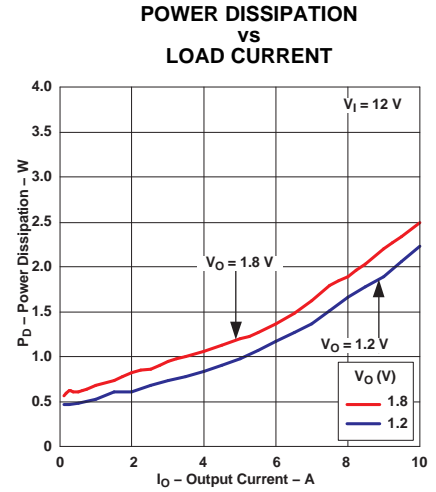

Figure 3.

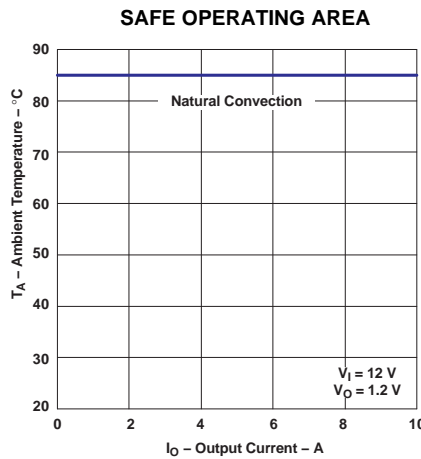

Figure 4.

- (1) The electrical characteristic data has been developed from actual products tested at 25°C. This data is considered typical for the converter. Applies to [Figure 1](#), [Figure 2](#), and [Figure 3](#).
- (2) The temperature derating curves represent the conditions at which internal components are at or below the manufacturer's maximum operating temperatures. Derating limits apply to modules soldered directly to a 100 mm x 100 mm double-sided PCB with 2 oz. copper. For surface mount packages (AS and AZ suffix), multiple vias must be utilized. Please refer to the mechanical specification for more information. Applies to [Figure 4](#).

PRODUCT PREVIEW

TYPICAL CHARACTERISTICS<sup>(1)(2)</sup>

CHARACTERISTIC DATA ( $V_I = 5\text{ V}$ )

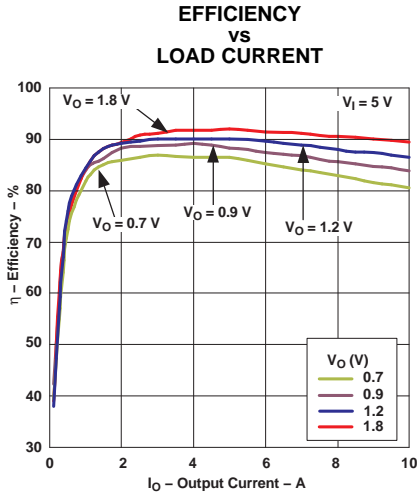

Figure 5.

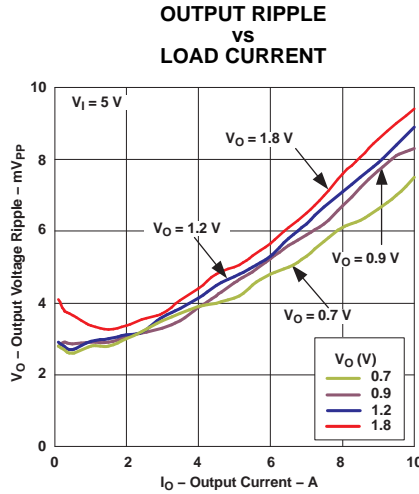

Figure 6.

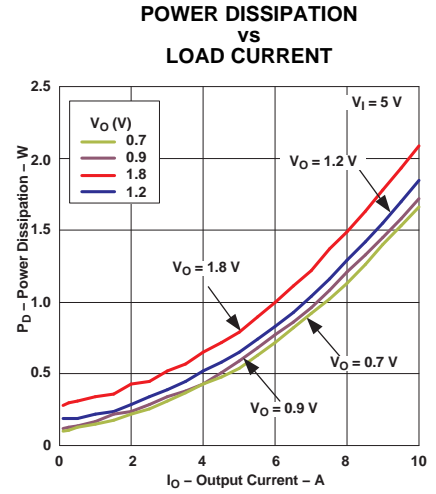

Figure 7.

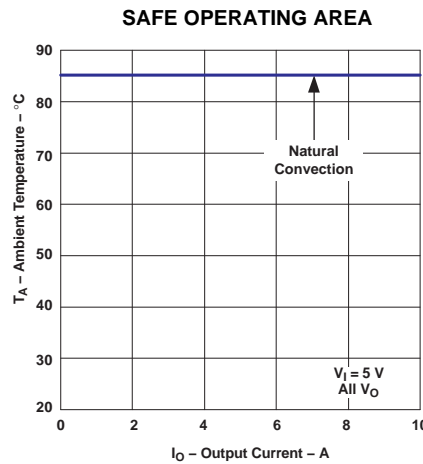

Figure 8.

- (1) The electrical characteristic data has been developed from actual products tested at 25°C. This data is considered typical for the converter. Applies to [Figure 5](#), [Figure 6](#), and [Figure 7](#).
- (2) The temperature derating curves represent the conditions at which internal components are at or below the manufacturer's maximum operating temperatures. Derating limits apply to modules soldered directly to a 100 mm x 100 mm double-sided PCB with 2 oz. copper. For surface mount packages (AS and AZ suffix), multiple vias must be utilized. Please refer to the mechanical specification for more information. Applies to [Figure 8](#).

PRODUCT PREVIEW



## APPLICATION INFORMATION

### ADJUSTING THE OUTPUT VOLTAGE

The  $V_O$  Adjust control (pin 8) sets the output voltage of the PTH08T240F. The adjustment range is 0.69 V to 2.0 V. The adjustment method requires the addition of a single external resistor,  $R_{SET}$ , that must be connected directly between the  $V_O$  Adjust and  $-Sense$  pins. Table 1 gives the standard value of the external resistor for a number of standard voltages, along with the actual output voltage that this resistance value provides.

For other output voltages, the value of the required resistor can either be calculated using the following formula, or simply selected from the range of values given in Table 2. Figure 9 shows the placement of the required resistor.

$$R_{SET} = 10 \text{ k}\Omega \times \frac{0.69}{V_O - 0.69} - 1.43 \text{ k}\Omega \quad (1)$$

**Table 1. Standard Values of  $R_{SET}$  for Standard Output Voltages**

$V_O$ (Standard) (V)	$R_{SET}$ (Standard Value) (k $\Omega$ )	$V_O$ (Actual) (V)
1.8	4.75	1.807
1.5	6.98	1.510
1.2 (1)	12.1	1.200
1 (1)	20.5	1.004
0.7 (1)	681	0.700

- (1) The maximum input voltage is ( $V_O \times 11$ ) or 14 V, whichever is less. The maximum allowable input voltage is a function of switching frequency and may increase or decrease when the Smart Sync feature is utilized. Please review the Smart Sync application section for further guidance.

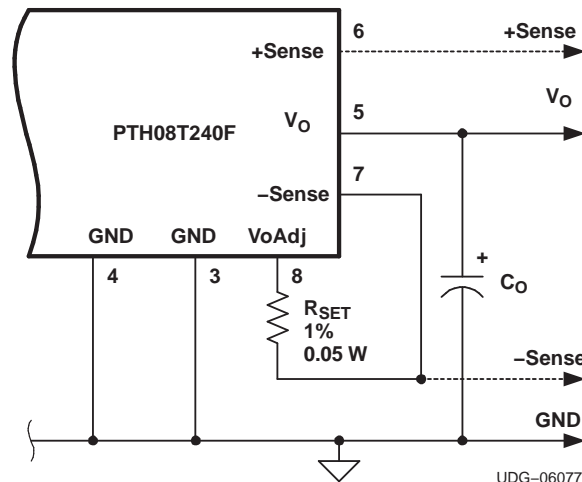

- (1)  $R_{SET}$ : Use a 0.05 W resistor with a tolerance of 1% and temperature stability of 100 ppm/ $^{\circ}$ C (or better). Connect the resistor directly between pins 8 and 7, as close to the regulator as possible, using dedicated PCB traces.
- (2) Never connect capacitors from  $V_O$  Adjust to either  $+Sense$ , GND, or  $V_O$ . Any capacitance added to the  $V_O$  Adjust pin affects the stability of the regulator.

**Figure 9.  $V_O$  Adjust Resistor Placement**

**Table 2. Output Voltage Set-Point Resistor Values  
(Standard Values)**

V <sub>O</sub> Required (V)	R <sub>SET</sub> (kΩ)
0.70 <sup>(1)</sup>	681
0.75 <sup>(1)</sup>	113
0.80 <sup>(1)</sup>	61.9
0.85 <sup>(1)</sup>	41.2
0.90 <sup>(1)</sup>	31.6
0.95 <sup>(1)</sup>	24.9
1.00 <sup>(1)</sup>	20.5
1.05 <sup>(1)</sup>	17.8
1.10 <sup>(1)</sup>	15.4
1.15 <sup>(1)</sup>	13.3
1.20 <sup>(1)</sup>	12.1
1.25 <sup>(1)</sup>	10.7
1.30	9.88
1.35	9.09
1.40	8.25
1.45	7.68
1.50	6.98
1.55	6.49
1.60	6.04
1.65	5.76
1.70	5.36
1.75	5.11
1.80	4.75
1.85	4.53
1.90	4.22
1.95	4.02
2.00	3.83

- (1) The maximum input voltage is (V<sub>O</sub> × 11) or 14 V, whichever is less. The maximum allowable input voltage is a function of switching frequency and may increase or decrease when the Smart Sync feature is utilized. Please review the Smart Sync application section for further guidance.

## TurboTrans™ Technology

TurboTrans technology is a feature introduced in the T2 generation of the PTH/PTV family of power modules. TurboTrans optimizes the transient response of the regulator with added external capacitance using a single external resistor. Benefits of this technology include reduced output capacitance, minimized output voltage deviation following a load transient, and enhanced stability when using ultra-low ESR output capacitors. The amount of output capacitance required to meet a target output voltage deviation will be reduced with TurboTrans activated. Likewise, for a given amount of output capacitance, with TurboTrans engaged, the amplitude of the voltage deviation following a load transient will be reduced. Applications requiring tight transient voltage tolerances and minimized capacitor footprint area will benefit greatly from this technology.

## TurboTrans™ Selection

Utilizing TurboTrans requires connecting a resistor,  $R_{TT}$ , between the +Sense pin (pin 6) and the TurboTrans pin (pin 9). The value of the resistor directly corresponds to the amount of output capacitance required. All T2 products require a minimum value of output capacitance whether or not TurboTrans is utilized. For the PTH08T240F, the minimum required capacitance is 1000  $\mu\text{F}$ . When using TurboTrans, capacitors with a capacitance  $\times$  ESR product below 10,000  $\mu\text{F}\times\text{m}\Omega$  are required. (Multiply the capacitance (in  $\mu\text{F}$ ) by the ESR (in  $\text{m}\Omega$ ) to determine the capacitance  $\times$  ESR product.) See the Capacitor Selection section of the datasheet for a variety of capacitors that meet this criteria.

Figure 10 shows the amount of output capacitance required to meet a desired transient voltage deviation with and without TurboTrans for Type C (e.g. OS-CON) capacitors; Type B (e.g. polymer-tantalum) capacitor charts will be added. To calculate the proper value of  $R_{TT}$ , first determine your required transient voltage deviation limits and magnitude of your transient load step. Next, determine what type of output capacitors will be used. (If more than one type of output capacitor is used, select the capacitor type that makes up the majority of your total output capacitance.) Knowing this information, use the chart (Figure 10; for Type C capacitors) that corresponds to the capacitor type selected. To use the chart, begin by dividing the maximum voltage deviation limit (in mV) by the magnitude of your load step (in Amps). This gives a mV/A value. Find this value on the Y-axis of the appropriate chart. Read across the graph to the 'With TurboTrans' plot. From this point, read down to the X-axis which lists the minimum required capacitance,  $C_O$ , to meet that transient voltage deviation. The required  $R_{TT}$  resistor value can then be calculated using the equation or selected from the TurboTrans table. The TurboTrans tables include both the required output capacitance and the corresponding  $R_{TT}$  values to meet several values of transient voltage deviation for 25% (2.5 A), 50% (5 A), and 75% (7.5 A) output load steps.

The chart can also be used to determine the achievable transient voltage deviation for a given amount of output capacitance. By selecting the amount of output capacitance along the X-axis, reading up to the desired 'With TurboTrans' curve, and then over to the Y-axis, gives the transient voltage deviation limit for that value of output capacitance. The required  $R_{TT}$  resistor value can be calculated using the equation or selected from the TurboTrans table.

As an example, let's look at a 5-V application requiring a 15 mV deviation during an 5 A, 50% load transient. A majority of 680  $\mu\text{F}$ , 10  $\text{m}\Omega$  output capacitors will be used. Use the 5-V, Type C capacitor chart, Figure 10. Dividing 15 mV by 5 A gives 3 mV/A transient voltage deviation per amp of transient load step. Select 3 mV/A on the Y-axis and read across to the 'With TurboTrans' plot. Following this point down to the X-axis gives a minimum required output capacitance of approximately 3000  $\mu\text{F}$ . The required  $R_{TT}$  resistor value for 3000  $\mu\text{F}$  can then be calculated or selected from Table 3. The required  $R_{TT}$  resistor is approximately 13.0 k $\Omega$ .

PTH08T240F Type C Capacitors

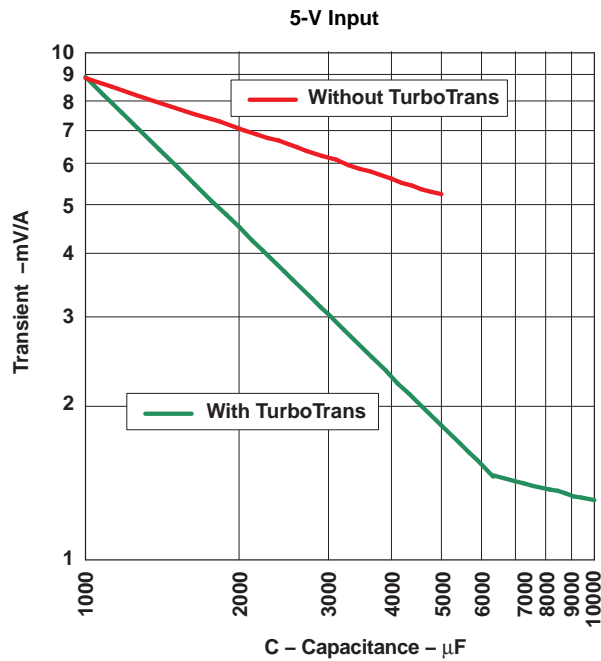

Figure 10. Capacitor Type C,  $5000 < C(\mu\text{F}) \times \text{ESR}(\text{m}\Omega) \leq 10,000$  (e.g. OS-CON)

Table 3. Type C TurboTrans  $C_O$  Values and Required  $R_{TT}$  Selection Table

Transient Voltage Deviation (mV)			5-V Input	
25% load step (2.5 A)	50% load step (5 A)	75% load step (7.5 A)	$C_O$ Minimum Required Output Capacitance (μF)	$R_{TT}$ Required TurboTrans Resistor (kΩ)
23	45	68	1000	open
20	40	60	1150	274
18	35	53	1300	133
15	30	45	1500	76.8
13	25	38	1810	44.2
10	20	30	2300	24.9
8	15	23	3050	12.7
5	10	15	4620	3.74

**$R_{TT}$  Resistor Selection**

The TurboTrans resistor value,  $R_{TT}$  can be determined from the TurboTrans programming, see [Equation 2](#).

$$R_{TT} = \frac{40 \times [1 - (C_O/6300)]}{\left[ \left( \frac{(5 \times C_O) + 1300}{6300} \right) - 1 \right]} \text{ (k}\Omega\text{)} \tag{2}$$

Where  $C_O$  is the total output capacitance in μF.  $C_O$  values greater than or equal to 6300 μF require  $R_{TT}$  to be a short, 0Ω. ( $R_{TT}$  results in a negative value when  $C_O > 6300$  μF).

To ensure stability, the value of  $R_{TT}$  must be calculated using the minimum required output capacitance determined from the capacitor transient response charts above.

# MECHANICAL DATA

## EBS (R-PDSS-T11)

## DOUBLE SIDED MODULE

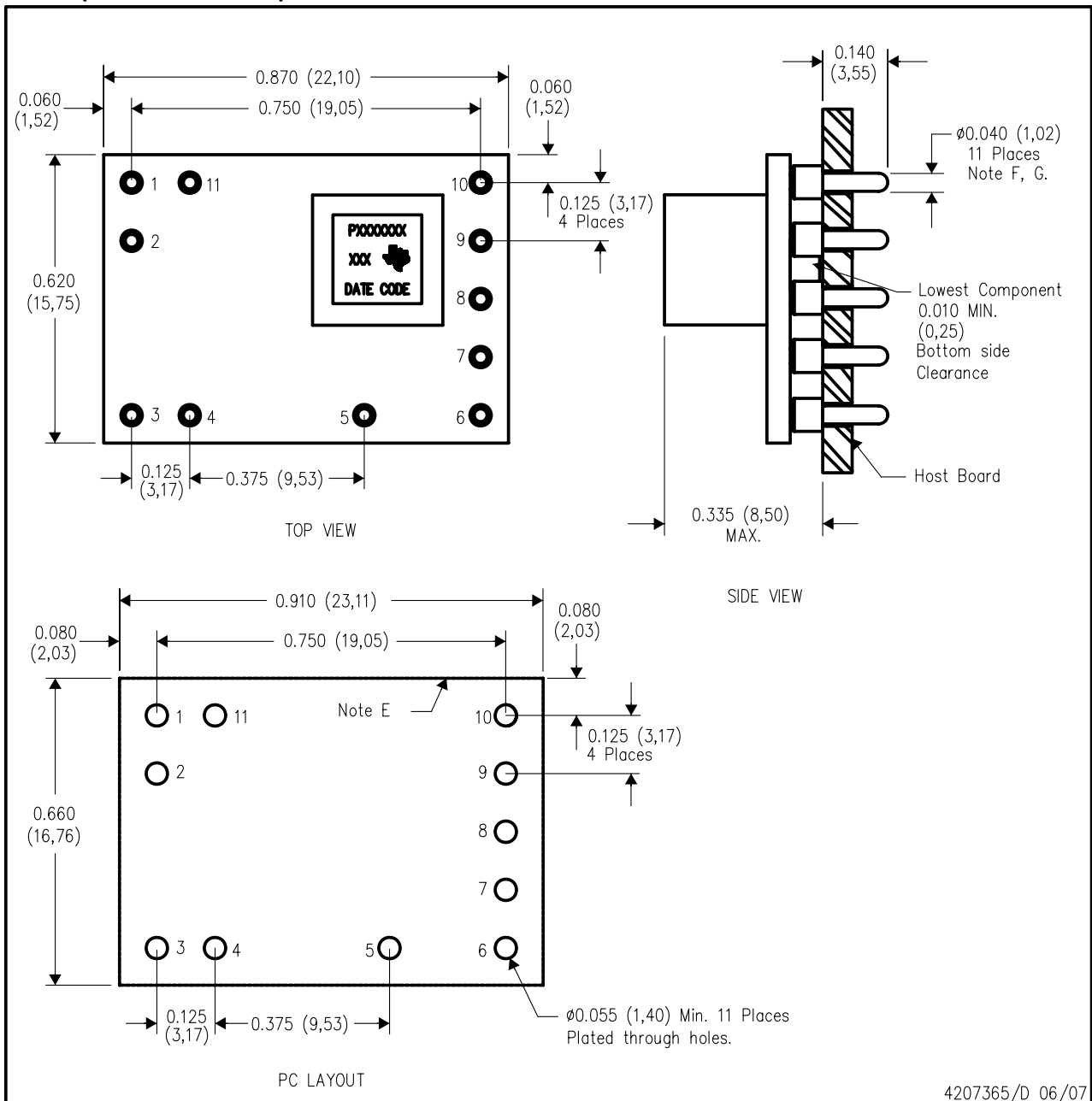

- NOTES:
- A. All linear dimensions are in inches (mm).
  - B. This drawing is subject to change without notice.
  - C. 2 place decimals are  $\pm 0.030$  ( $\pm 0.76$ mm).
  - D. 3 place decimals are  $\pm 0.010$  ( $\pm 0.25$ mm).
  - E. Recommended keep out area for user components.

- F. Pins are 0.040" (1,02) diameter with 0.070" (1,78) diameter standoff shoulder.
- G. All pins: Material - Copper Alloy  
Finish - Tin (100%) over Nickel plate

# MECHANICAL DATA

## EBT (R-PDSS-B11)

## DOUBLE SIDED MODULE

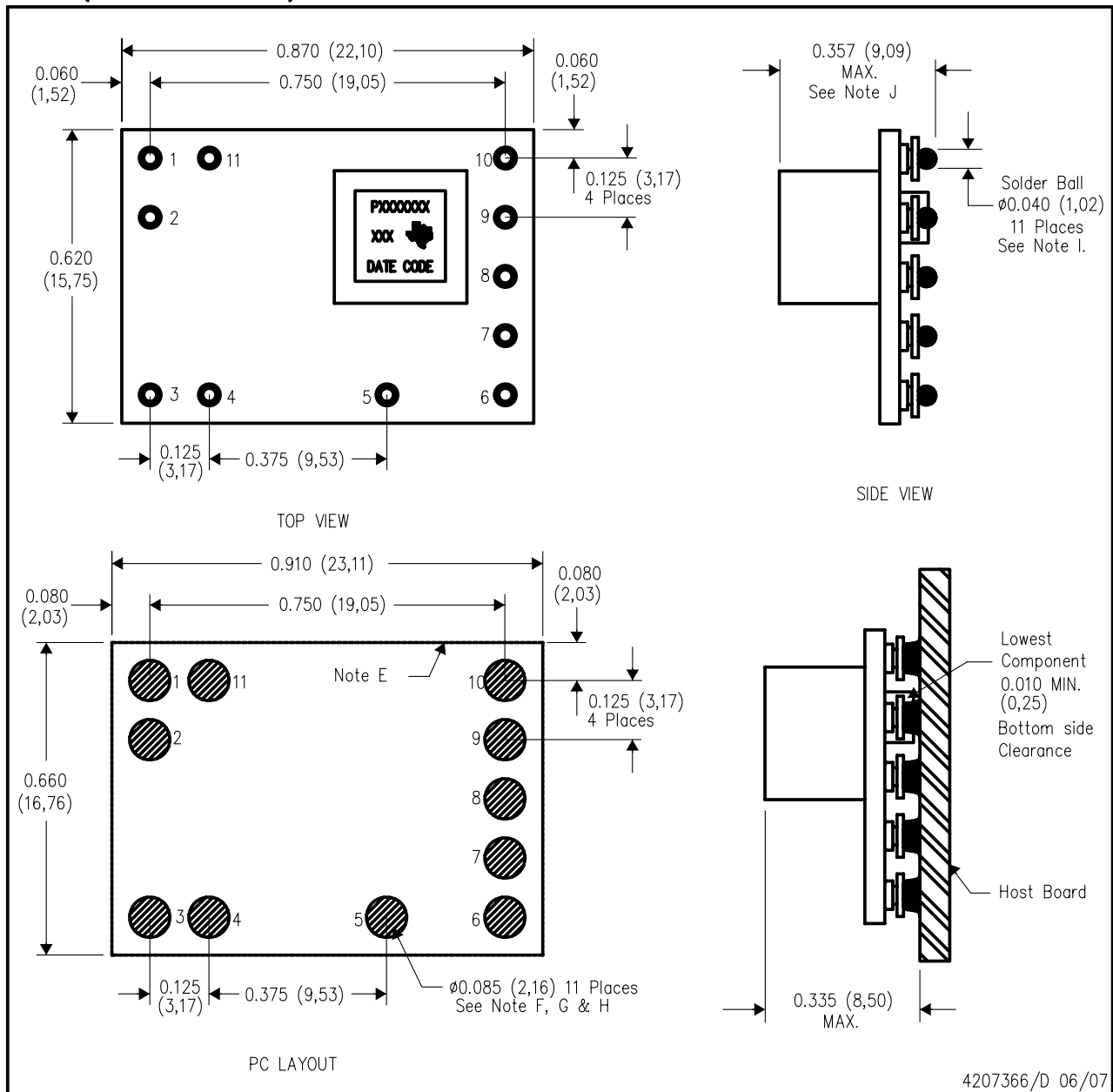

- NOTES:
- All linear dimensions are in inches (mm).
  - This drawing is subject to change without notice.
  - 2 place decimals are  $\pm 0.030$  ( $\pm 0,76$ mm).
  - 3 place decimals are  $\pm 0.010$  ( $\pm 0,25$ mm).
  - Recommended keep out area for user components.
  - Power pin connection should utilize two or more vias to the interior power plane of 0.025 (0,63) I.D. per input, ground and output pin (or the electrical equivalent).

- Paste screen opening: 0.080 (2,03) to 0.085 (2,16).  
Paste screen thickness: 0.006 (0,15).
- Pad type: Solder mask defined.
- All pins: Material – Copper Alloy  
Finish – Tin (100%) over Nickel plate  
Solder Ball – See product data sheet.
- Dimension prior to reflow solder.

## IMPORTANT NOTICE

Texas Instruments Incorporated and its subsidiaries (TI) reserve the right to make corrections, modifications, enhancements, improvements, and other changes to its products and services at any time and to discontinue any product or service without notice. Customers should obtain the latest relevant information before placing orders and should verify that such information is current and complete. All products are sold subject to TI's terms and conditions of sale supplied at the time of order acknowledgment.

TI warrants performance of its hardware products to the specifications applicable at the time of sale in accordance with TI's standard warranty. Testing and other quality control techniques are used to the extent TI deems necessary to support this warranty. Except where mandated by government requirements, testing of all parameters of each product is not necessarily performed.

TI assumes no liability for applications assistance or customer product design. Customers are responsible for their products and applications using TI components. To minimize the risks associated with customer products and applications, customers should provide adequate design and operating safeguards.

TI does not warrant or represent that any license, either express or implied, is granted under any TI patent right, copyright, mask work right, or other TI intellectual property right relating to any combination, machine, or process in which TI products or services are used. Information published by TI regarding third-party products or services does not constitute a license from TI to use such products or services or a warranty or endorsement thereof. Use of such information may require a license from a third party under the patents or other intellectual property of the third party, or a license from TI under the patents or other intellectual property of TI.

Reproduction of TI information in TI data books or data sheets is permissible only if reproduction is without alteration and is accompanied by all associated warranties, conditions, limitations, and notices. Reproduction of this information with alteration is an unfair and deceptive business practice. TI is not responsible or liable for such altered documentation. Information of third parties may be subject to additional restrictions.

Resale of TI products or services with statements different from or beyond the parameters stated by TI for that product or service voids all express and any implied warranties for the associated TI product or service and is an unfair and deceptive business practice. TI is not responsible or liable for any such statements.

TI products are not authorized for use in safety-critical applications (such as life support) where a failure of the TI product would reasonably be expected to cause severe personal injury or death, unless officers of the parties have executed an agreement specifically governing such use. Buyers represent that they have all necessary expertise in the safety and regulatory ramifications of their applications, and acknowledge and agree that they are solely responsible for all legal, regulatory and safety-related requirements concerning their products and any use of TI products in such safety-critical applications, notwithstanding any applications-related information or support that may be provided by TI. Further, Buyers must fully indemnify TI and its representatives against any damages arising out of the use of TI products in such safety-critical applications.

TI products are neither designed nor intended for use in military/aerospace applications or environments unless the TI products are specifically designated by TI as military-grade or "enhanced plastic." Only products designated by TI as military-grade meet military specifications. Buyers acknowledge and agree that any such use of TI products which TI has not designated as military-grade is solely at the Buyer's risk, and that they are solely responsible for compliance with all legal and regulatory requirements in connection with such use.

TI products are neither designed nor intended for use in automotive applications or environments unless the specific TI products are designated by TI as compliant with ISO/TS 16949 requirements. Buyers acknowledge and agree that, if they use any non-designated products in automotive applications, TI will not be responsible for any failure to meet such requirements.

Following are URLs where you can obtain information on other Texas Instruments products and application solutions:

<b>Products</b>		<b>Applications</b>	
Amplifiers	<a href="http://amplifier.ti.com">amplifier.ti.com</a>	Audio	<a href="http://www.ti.com/audio">www.ti.com/audio</a>
Data Converters	<a href="http://dataconverter.ti.com">dataconverter.ti.com</a>	Automotive	<a href="http://www.ti.com/automotive">www.ti.com/automotive</a>
DSP	<a href="http://dsp.ti.com">dsp.ti.com</a>	Broadband	<a href="http://www.ti.com/broadband">www.ti.com/broadband</a>
Interface	<a href="http://interface.ti.com">interface.ti.com</a>	Digital Control	<a href="http://www.ti.com/digitalcontrol">www.ti.com/digitalcontrol</a>
Logic	<a href="http://logic.ti.com">logic.ti.com</a>	Military	<a href="http://www.ti.com/military">www.ti.com/military</a>
Power Mgmt	<a href="http://power.ti.com">power.ti.com</a>	Optical Networking	<a href="http://www.ti.com/opticalnetwork">www.ti.com/opticalnetwork</a>
Microcontrollers	<a href="http://microcontroller.ti.com">microcontroller.ti.com</a>	Security	<a href="http://www.ti.com/security">www.ti.com/security</a>
RFID	<a href="http://www.ti-rfid.com">www.ti-rfid.com</a>	Telephony	<a href="http://www.ti.com/telephony">www.ti.com/telephony</a>
Low Power Wireless	<a href="http://www.ti.com/lpw">www.ti.com/lpw</a>	Video & Imaging	<a href="http://www.ti.com/video">www.ti.com/video</a>
		Wireless	<a href="http://www.ti.com/wireless">www.ti.com/wireless</a>

Mailing Address: Texas Instruments, Post Office Box 655303, Dallas, Texas 75265  
Copyright © 2007, Texas Instruments Incorporated