

FEATURES

- Wide Operating Voltage Range (3 to 13 V)
- Low Distortion (typ. 0.004%)
- Wide Dynamic Range (typ. 6 V_{P.P.})
- Low Output Impedance (typ. 20 Ω)
- Protection at Output Terminal.
- Direct Coupling Possible.

APPLICATIONS

- Audio Systems
- Radio Cassettes

DESCRIPTION

The TK15211M is an Analog Switch IC that was developed for audio frequency applications. The function of the IC is to select one output from two input channels. The channel selection is controlled by a low level. The TK15211M operates from a single power supply. The input bias circuitry is provided externally, making the device suitable for various signal switching applications, especially Hi-Fi devices. The TK15211M offers a wide operating voltage range with simple associated circuitry.

The TK15211M is available in the small SOT23L-6 plastic surface mount packages.

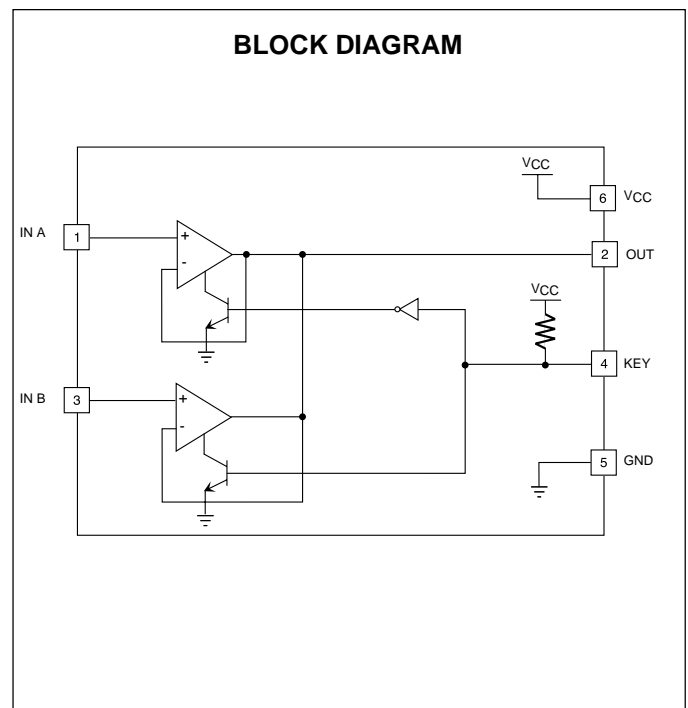
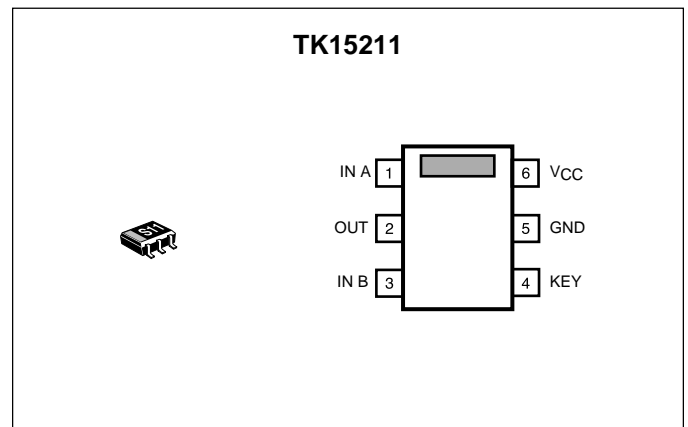

ORDERING INFORMATION

TK15211M □□

└─ Tape/Reel Code

TAPE/REEL CODE
TL: Tape Left

TK15211

ABSOLUTE MAXIMUM RATINGS

Supply Voltage 14 V
 Operating Voltage Range 3 to 13 V
 Power Dissipation (Note 5) 200 mW
 Storage Temperature Range -55 to +150 °C
 Operating Temperature Range -20 to +75 °C
CONTROL SECTION
 Input Voltage -0.3 V to $V_{CC} + 0.3$ V

ANALOG SWITCH SECTION

Signal Input Voltage -0.3 V to $V_{CC} + 0.3$ V
 Signal Output Current 3 mA
 Maximum Input Frequency 100 kHz
 Lead Soldering Temperature 235 °C

TK15210M ELECTRICAL CHARACTERISTICS

Test conditions: $V_{CC} = 8.0$ V, $T_A = 25$ °C, unless otherwise specified.

SYMBOL	PARAMETER	TEST CONDITIONS	MIN	TYP	MAX	UNITS
I_{CC}	Supply Current			2.2	4.6	mA
KEY CONTROL SECTION						
V_{IL}	Input Voltage Low Level	Note 1	-0.3		+0.6	V
V_{IH}	Input Voltage High Level		2.0		$V_{CC} + 0.3$	V
$I_{OUT(KEY)}$	Outflow Current	Pin 4 connected to GND			30	μ A
ANALOG SWITCH SECTION						
THD	Total Harmonic Distortion	$V_{IN} = 1$ Vrms, $f = 1$ kHz		0.004	0.008	%
N_L	Residual Noise	Note 2			10	μ Vrms
CT	Cross Talk	$V_{IN} = 1$ Vrms, $f = 10$ kHz, Note 3		-80	-75	dB
DYN	Maximum Input Signal Level	$f = 1$ kHz, THD = 0.1%	2.0			Vrms
GVA	Voltage Gain	$f = \sim 20$ kHz		0		dB
V_{cent}	Input-Output Terminal Voltage	$V_{OUT} =$ supply voltage from outside	$V_{OUT} - 0.2$	V_{OUT}	$V_{OUT} + 0.2$	V
ΔV_{cent}	Output Terminal Voltage Difference				14	mV
I_{IN}	Input Bias Current	Note 4		0.5		μ A
Z_{OUT}	Output Impedance	DC Impedance		20		Ω

- Note 1: The KEY input equivalent circuit is shown to the right in Figure A. When the control pin is open, the input is pulled up to a high level (approximately 1.4 V). This applies the channel A input signal to the output. A low level changes the output to the channel B input signal.
- Note 2: This value measured with a capacitor connected between the input terminal and ground. See Figure 7.
- Note 3: This value measured with a 5 k Ω resistor and series capacitor connected between the input terminal and ground. See Figure 8.
- Note 4: The input equivalent circuit is shown to the right in Figure B. The standard application of the TK15211M is direct coupling with external input bias.
- Note 5: Power dissipation is 200 mW when mounted as recommended. Derate at 1.6 mW/°C for operation above 25°C.

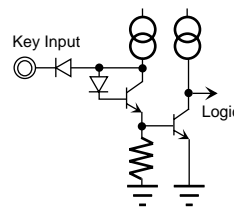

Figure A

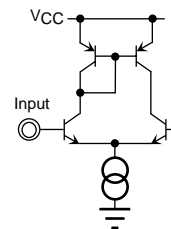
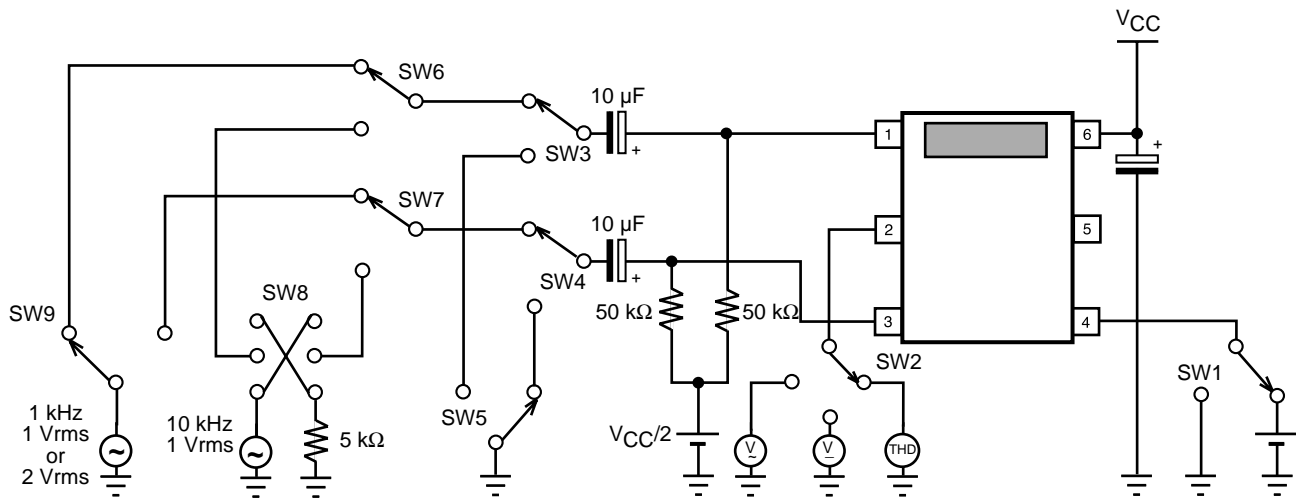

Figure B

TEST CIRCUITS AND METHODS



- 1: The above condition tests the dynamic range measurement for channel A.
- 2: SW5 is for residual noise measurement.
- 3: SW8 is for cross talk measurement.

SUPPLY CURRENT (FIGURE 1)

This current is a consumption current with a nonloading condition.

- 1) Bias supply to Pin 1 and Pin 3. (This condition is the same with the other measurements too, omits from next).
- 2) Measure the inflow current to Pin 6 from VCC. This current is the supply current.

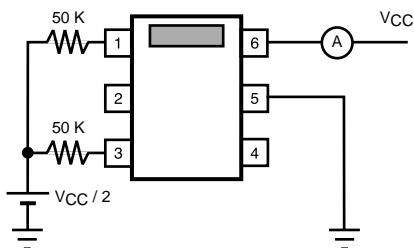

Figure 1

CONTROL LOW/HIGH LEVEL (FIGURE 2)

This level is to measure the threshold level.

- 1) Input, the V_{CC} to Pin 6. (This condition is the same with the other measurements, omitted from the next for simplicity.)
- 2) Input to Pin 1 with sine wave (1 kHz, 1 Vrms).

- 3) Connect an oscilloscope to Pin 2.

- 4) Elevate the Pin 4 voltage from 0 V gradually, until the sine wave appears at the oscilloscope. This voltage is the threshold level when the wave appears.

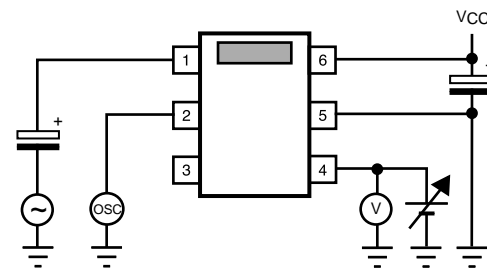

Figure 2

KEY INPUT CURRENT (FIGURE 3)

This current means the outflow current with the control terminal.

- 1) Measure the current to GND from Pin 4. This current is the outflow current.

TEST CIRCUITS AND METHODS (CONT.)

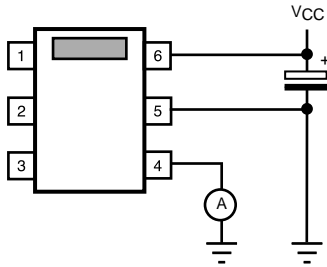

Figure 3

TOTAL HARMONIC DISTORTION (FIGURE 4)

Use the lower distortion oscillator for this measurement because distortion of the TK15211 is very low.

- 1) Pin 4 is the open condition, or high level.
- 2) Connect a distortion analyzer to Pin 2.
- 3) Input the sine wave (1 kHz, 1 Vrms) to Pin 1.
- 4) Measure the distortion of Pin 2. This value is the distortion of Ach.
- 5) Next connect Pin 4 to the GND, or low level.
- 6) Input the same sine wave to Pin 3.
- 7) Measure in the same way. This value is the distortion of Bch.

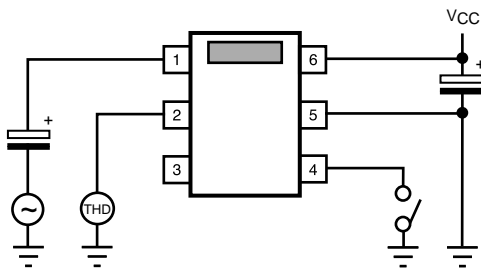

Figure 4

VOLTAGE GAIN (FIGURE 5)

This is the output level against input level.

- 1) Pin 4 is in the open condition, or high level.
- 2) Connect AC volt meters to Pin 1 and Pin 3.
- (Using the same type meter is best)
- 3) Input sine wave (1 kHz) to Pin 1 (f = optional up to max. 20 kHz, 1 Vrms).
- 4) Measure the level of Pin 1 and name this V1.
- 5) Measure the level of Pin 2 and name this V2.

- 6) Calculate Gain = $20 \text{ Log } ((|V2 - V1|)/V1)$
 $V1 < V2 = + \text{ Gain}, V1 > V2 = - \text{ Gain}$
 This value is the voltage gain of Ach.
- 7) Next, connect Pin 4 to the GND, or low level.
- 8) Input the same sine wave to Pin 3.
- 9) Measure and calculate in the same way.
 This value is the voltage gain of Bch.

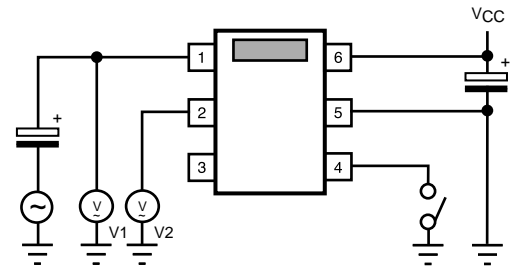

Figure 5

MAXIMUM INPUT LEVEL (FIGURE 6)

This measurement measures at the output side.

- 1) Pin 4 is the open condition, or high level.
- 2) Connect a distortion analyzer and an AC volt meter to Pin 2.
- 3) Input a sine wave (1 kHz) to Pin 1 and elevate the voltage from 0 V gradually until the distortion gets to 0.1% at Pin 2.
- 4) When the distortion amounts to 0.1%, stop elevating and measure the AC level of Pin 2.
 This value is the maximum input level of Ach.
- 5) Next, connect Pin 4 to the GND, or low level.
- 6) Input the same sine wave to Pin 3.
- 7) Measure in the same way.
 This value is the maximum input level of Bch.

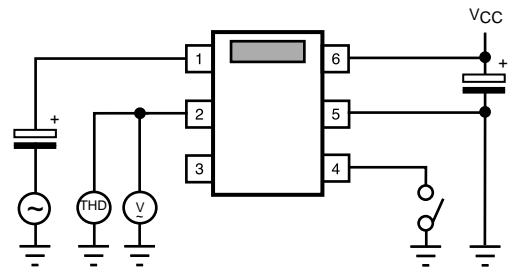

Figure 6

TEST CIRCUITS AND METHODS (CONT.)

RESIDUAL NOISE (FIGURE 7)

This value is not a S/N ratio. This is a noise which occurs from the device itself.

- 1) Pin 4 is in the open condition, or high level.
- 2) Connect an AC volt meter to Pin 2.
- 3) Connect a capacitor to GND from Pin 1.
- 4) Measure the AC voltage of Pin 2. This value is the noise of Ach. If the influence of noise from outside exists, use optional filters.
- 5) Next, connect Pin 4 to the GND, or low level.
- 6) Remove the capacitor of Pin 1 and connect the capacitor to Pin 3.
- 7) Measure in the same way.
This value is the noise level of Bch.

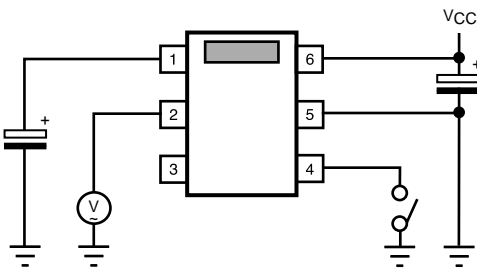

Figure 7

CROSS TALK (FIGURE 8)

This is the cross talk between Ach and Bch.

- 1) Pin 4 is the open condition, or high level.
- 2) Connect AC voltmeters to Pin 2 and Pin 3.
- 3) Connect a capacitor and a resistance in series to GND from Pin 1.
- 4) Input sine wave (10 kHz, 1 Vrms) to Pin 3.
- 5) Measure the level of Pin 3 and name this V3.
- 6) Measure the level of Pin 2 and name this V4.
- 7) Calculate:

$$\text{Cross Talk} = 20 \text{ Log } (V4 / V3)$$
 This value is the cross talk to Ach from Bch.
- 8) Next, connect Pin 4 to the GND, or low level.
- 9) Change line of Pin 1 and Pin 3.
- 10) Input the same sine wave to Pin 1.
- 11) Measure and calculate in the same way.
This value is the isolation to Bch from Ach.

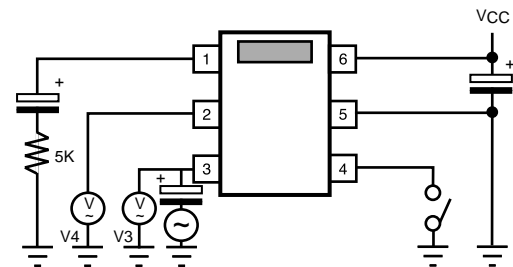

Figure 8

I/O TERMINAL VOLTAGE (FIGURE 9)

This is the DC voltage of input and output. Because the input and the output are nearly equal, only the output is measured.

- 1) Pin 4 is in the open condition, or high level.
- 2) Connect a DC voltmeter to Pin 2 and measure.
This value is the terminal voltage of Ach.
- 3) Next, connect Pin 4 to the GND, or low level.
- 4) Measure in the same way.
This value is the terminal voltage of Bch.

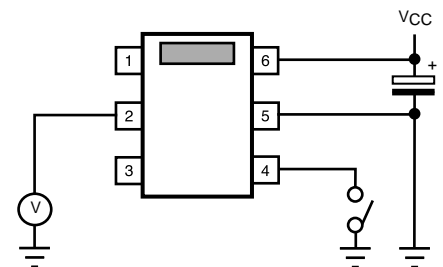

Figure 9

OUTPUT TERMINAL DIFFERENCE

This is the DC output voltage difference between Ach and Bch. This is calculated by using values measured at the I/O Terminal Voltage.

$$\Delta V_{\text{cent}} = | (\text{Ach DC output value}) - (\text{Bch DC output value}) |$$

This value is the voltage difference.

TYPICAL PERFORMANCE CHARACTERISTICS

$V_{CC} = 8\text{ V}$, Input Bias Voltage = 4 V, $T_A = 25\text{ }^\circ\text{C}$, unless otherwise specified.

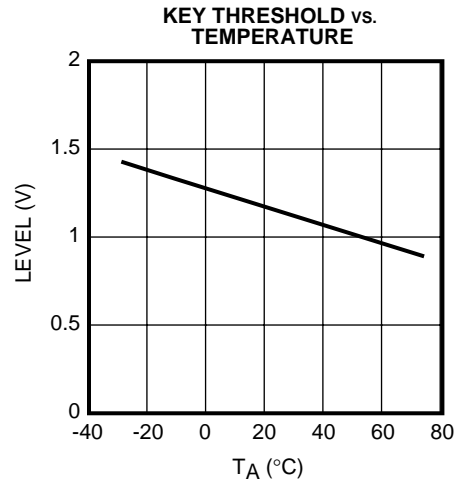
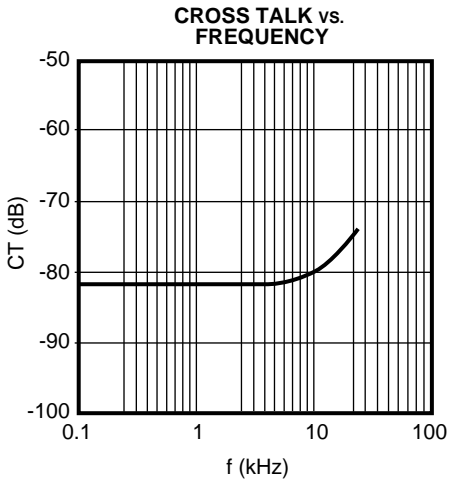
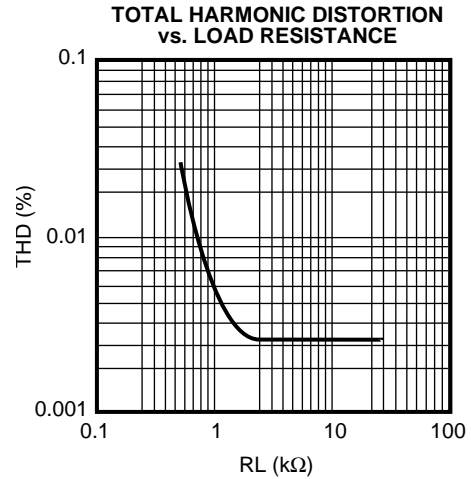
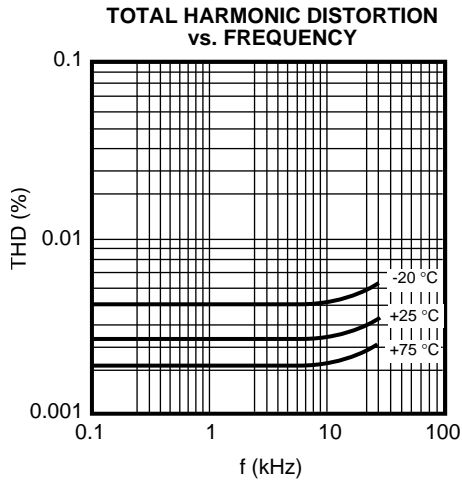
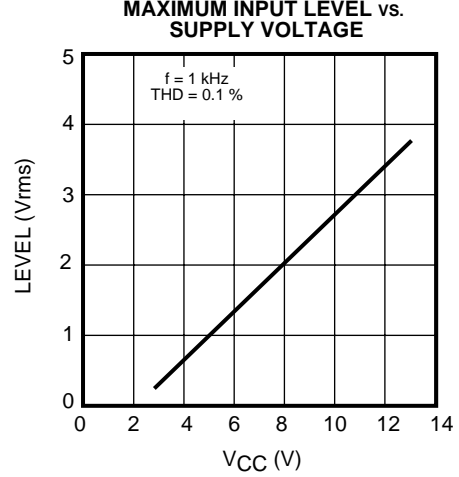
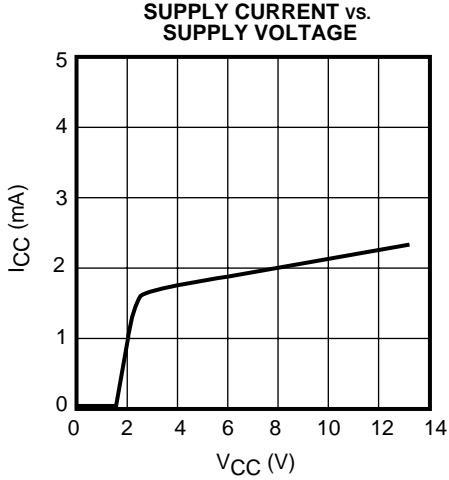

TYPICAL PERFORMANCE CHARACTERISTICS (CONT.)

$V_{CC} = 8\text{ V}$, Input Bias Voltage = 4 V, $T_A = 25\text{ }^\circ\text{C}$, unless otherwise specified.

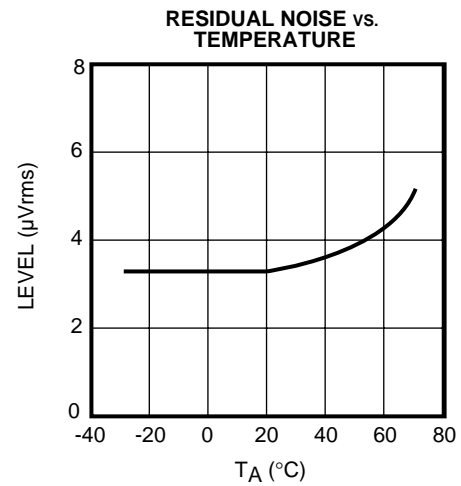
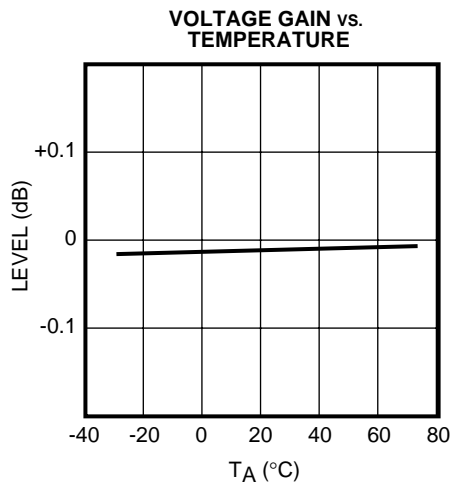

TK15211

TERMINAL VOLTAGE AND CIRCUIT

Condition: $V_{CC} = 8\text{ V}$, Input Bias Voltage = 4 V.

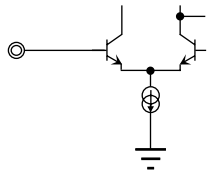
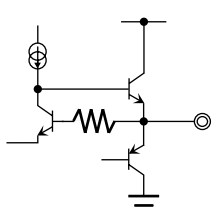
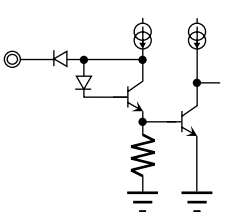
PIN NO.	ASSIGNMENT	DC VOLTAGE	CIRCUIT/FUNCTION
1 3	IN A IN B	4 V	 <p>Signal Input Pin</p>
2	OUT	4 V	 <p>Signal Output Pin</p>
4	KEY	1.4 V	 <p>Key Input Pin</p>
5	GND	0 V	Ground Pin
6	V_{CC}	8 V	Supply Voltage Pin

APPLICATION INFORMATION

KEY INPUT CIRCUIT

Figure 10 illustrates the KEY input equivalent circuit. When the control pin is open, the input is pulled up to a high level (approximately 1.4 V). This applies the channel A input signal to the output. A low level changes the output to the channel B input signal. When the control terminal is pulled low, a current up to 30 μA may flow out of the terminal. For this reason, an external resistor value must be selected which results in a voltage of less than 0.8 V to maintain a low condition.

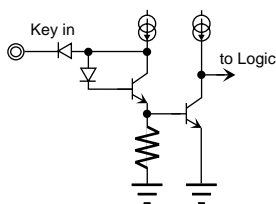

Figure 10

SWITCHING TIME

This time is the signal change response time compared to the control key input signal. Figure 11 illustrates the timing chart. $T = 2 \mu\text{s}$ typically.

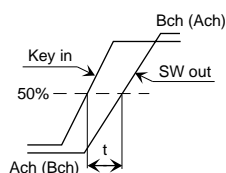

Figure 11

APPLICATION

Figure 12 illustrates an example of a typical application. The standard application of the TK15211M is to use direct coupling at the inputs and capacitor coupling at the output. For characteristics of distortion and dynamic range versus R_L , refer to the graphs in the Typical Performance Characteristics. The TK15211M can also be used with capacitor coupling on the inputs, but an external bias supply is required. If capacitor coupling is desired, it is recommended to use the TK15210M with built-in bias. The DC input bias of the TK15210M is $V_{CC}/2$.

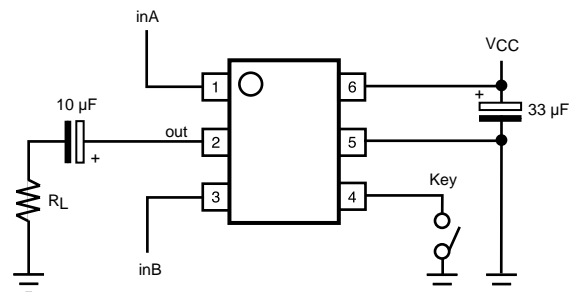

Figure 12

CROSS TALK

Figure 13 is an example of a layout pattern. Because the TK15211M is direct coupled, the influence of the application is minimal. However, in the capacitor coupled application of the TK15211M, the following must be considered. Because of the high impedance at the inputs, the capacitors can act as antennas to each other. If the parts are bigger, and the space between the capacitors is too narrow, then cross talk will increase. Therefore, when designing the printed circuit pattern, separate the input capacitors as far as possible and use as small a part as possible (e.g., surface mount types, etc.).

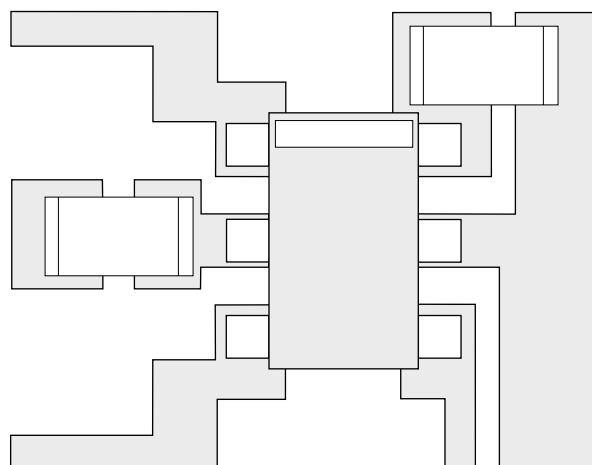

Figure 13

APPLICATION INFORMATION (CONT.)

OUTPUT TERMINAL VOLTAGE DIFFERENCE

This parameter is the output voltage difference between Ach and Bch, and appears when the channel changes from Ach to Bch, or changed to the reverse. Generally, this is called Switching Noise or Pop Noise. If this value is big and if this noise is amplified by the final amplifier and is outputted by the speakers, then it appears as a Shock Sound. The output terminal voltage difference of the TK15211M is a value that adds the internal bias difference and the off-set voltage difference. The value of the TK15211 is very small; its maximum value is 18 mV. Toko can offer the "Muting IC" if users wish to mute Switching Noise.

DIRECT CONTACT

The signal input terminals:

Internal circuits are operated by constant current circuit; even if V_{CC} or GND is contacted, damage does not occur.

The signal output terminal:

As for inflow, internal circuits are operated by constant current circuit; even if V_{CC} is contacted, damage does not occur.

Outflow is protected by the circuit. Even if the terminal is contacted to GND, damage does not happen. Package damage may occur due to heat. Pay attention to long time contact.

Do not supply over the maximum rating.

Referenced to GND, do not provide any terminal voltages over $V_{CC} +0.3 V$ or $-0.3 V$.

DC SIGNAL OUTPUT

The output of the TK15211M has a saturation voltage (both V_{CC} and GND sides of approximately 1.0 V); accordingly the use of a DC signal is not recommended (e.g., pulse signal etc.)

NOTES

PACKAGE OUTLINE

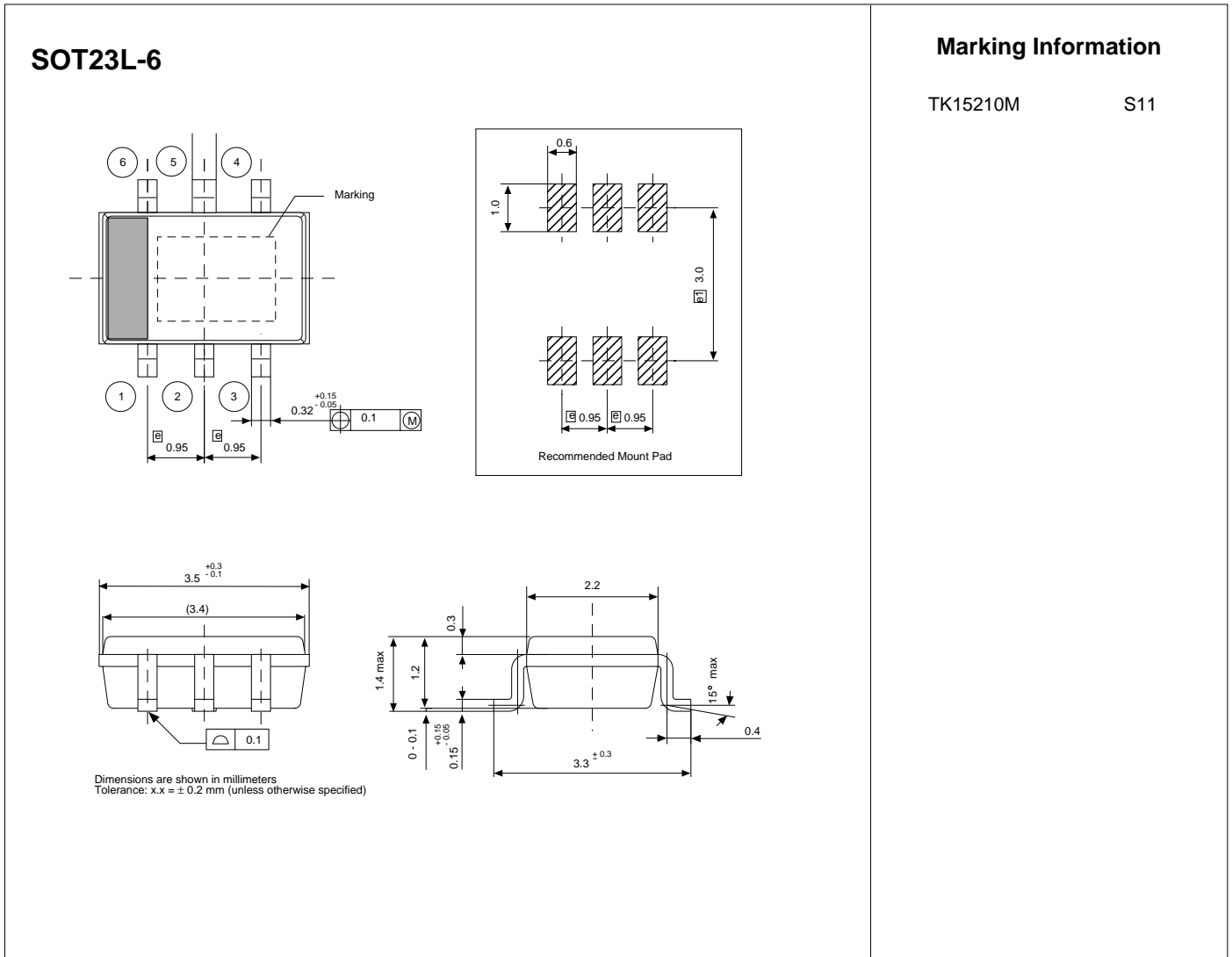

Toko America, Inc. Headquarters
 1250 Feehanville Drive, Mount Prospect, Illinois 60056
 Tel: (847) 297-0070 Fax: (847) 699-7864

TOKO AMERICA REGIONAL OFFICES

Midwest Regional Office
 Toko America, Inc.
 1250 Feehanville Drive
 Mount Prospect, IL 60056
 Tel: (847) 297-0070
 Fax: (847) 699-7864

Western Regional Office
 Toko America, Inc.
 2480 North First Street, Suite 260
 San Jose, CA 95131
 Tel: (408) 432-8281
 Fax: (408) 943-9790

Eastern Regional Office
 Toko America, Inc.
 107 Mill Plain Road
 Danbury, CT 06811
 Tel: (203) 748-6871
 Fax: (203) 797-1223

Semiconductor Technical Support
 Toko Design Center
 4755 Forge Road
 Colorado Springs, CO 80907
 Tel: (719) 528-2200
 Fax: (719) 528-2375

Visit our Internet site at <http://www.tokoam.com>

The information furnished by TOKO, Inc. is believed to be accurate and reliable. However, TOKO reserves the right to make changes or improvements in the design, specification or manufacture of its products without further notice. TOKO does not assume any liability arising from the application or use of any product or circuit described herein, nor for any infringements of patents or other rights of third parties which may result from the use of its products. No license is granted by implication or otherwise under any patent or patent rights of TOKO, Inc.