

- ◆ N-Channel Power MOS FET
- ◆ DMOS Structure
- ◆ Low On-State Resistance : 0.014Ω (max)
- ◆ Ultra High-Speed Switching
- ◆ SOP - 8 Package

- Applications
 - Notebook PCs
 - Cellular and portable phones
 - On - board power supplies
 - Li - ion battery systems

■ General Description

The XP131A1617SR is a N-Channel Power MOS FET with low on-state resistance and ultra high-speed switching characteristics. Because high-speed switching is possible, the IC can be efficiently set thereby saving energy. The small SOP-8 package makes high density mounting possible.

■ Features

- Low on-state resistance** : $R_{ds(on)} = 0.014\Omega$ ($V_{gs} = 4.5V$)
 $R_{ds(on)} = 0.019\Omega$ ($V_{gs} = 2.5V$)
- Ultra high-speed switching**
- Operational Voltage** : 2.5V
- High density mounting** : SOP - 8

■ Pin Configuration

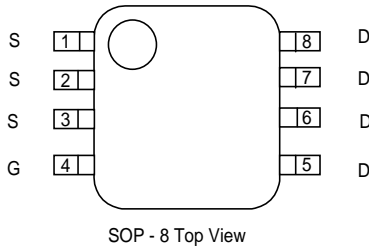

■ Pin Assignment

PIN NUMBER	PIN NAME	FUNCTION
1 - 3	S	Source
4	G	Gate
5 - 8	D	Drain

■ Equivalent Circuit

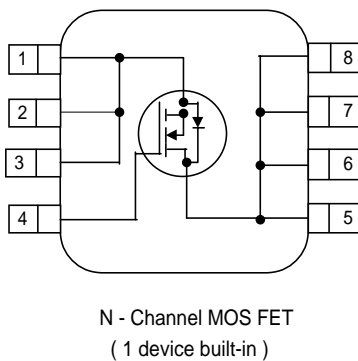

■ Absolute Maximum Ratings

$T_a = 25^\circ\text{C}$			
PARAMETER	SYMBOL	RATINGS	UNITS
Drain - Source Voltage	V_{dss}	20	V
Gate - Source Voltage	V_{gss}	± 12	V
Drain Current (DC)	I_d	10	A
Drain Current (Pulse)	I_{dp}	40	A
Reverse Drain Current	I_{dr}	10	A
Continuous Channel Power Dissipation (note)	P_d	2.5	W
Channel Temperature	T_{ch}	150	$^\circ\text{C}$
Storage Temperature	T_{stg}	-55 to 150	$^\circ\text{C}$

(note) : When implemented on a glass epoxy PCB

Electrical Characteristics

DC characteristics

Ta=25°C

PARAMETER	SYMBOL	CONDITIONS	MIN	TYP	MAX	UNITS
Drain Cut-off Current	Idss	Vds = 20 , Vgs = 0V			10	μA
Gate-Source Leakage Current	Igss	Vgs = ± 8 , Vds = 0V			± 1	μA
Gate-Source Cut-off Voltage	Vgs (off)	Id = 1mA , Vds = 10V	0.7		1.4	V
Drain-Source On-state Resistance (note)	Rds (on)	Id = 5A , Vgs = 4.5V		0.01	0.014	Ω
		Id = 5A , Vgs = 2.5V		0.013	0.019	Ω
Forward Transfer Admittance (note)	Yfs	Id = 5A , Vds = 10V		32		S
Body Drain Diode Forward Voltage	Vf	If = 10A , Vgs = 0V		0.8	1.1	V

(note) : Effective during pulse test.

Dynamic characteristics

Ta=25°C

PARAMETER	SYMBOL	CONDITIONS	MIN	TYP	MAX	UNITS
Input Capacitance	Ciss	Vds = 10V , Vgs = 0V f = 1 MHz		1650		pF
Output Capacitance	Coss			1000		pF
Feedback Capacitance	Crss			450		pF

Switching characteristics

Ta=25°C

PARAMETER	SYMBOL	CONDITIONS	MIN	TYP	MAX	UNITS
Turn-on Delay Time	td (on)	Vgs = 5V , Id = 5A Vdd = 10V		15		ns
Rise Time	tr			25		ns
Turn-off Delay Time	td (off)				65	ns
Fall Time	tf				15	ns

Thermal characteristics

PARAMETER	SYMBOL	CONDITIONS	MIN	TYP	MAX	UNITS
Thermal Resistance (channel - surroundings)	Rth (ch - a)	Implement on a glass epoxy resin PCB		50		°C / W

Electrical Characteristics

Drain Current vs. Drain/Source Voltage

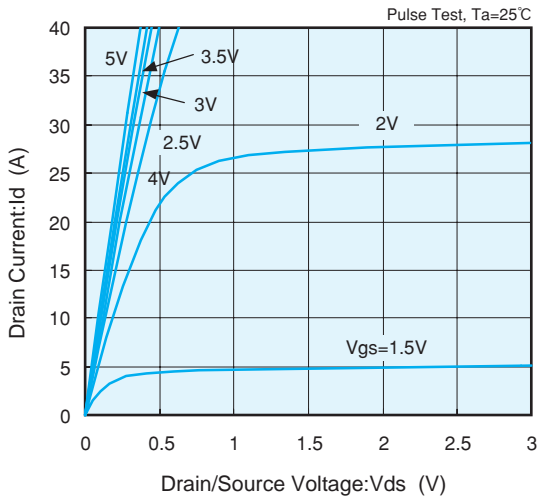

Drain/Source Voltage Vds (V)

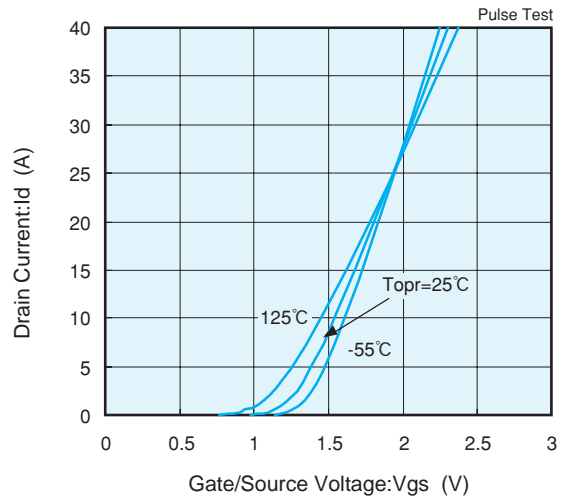

Drain/Source On-State Resistance vs. Gate/Source Voltage

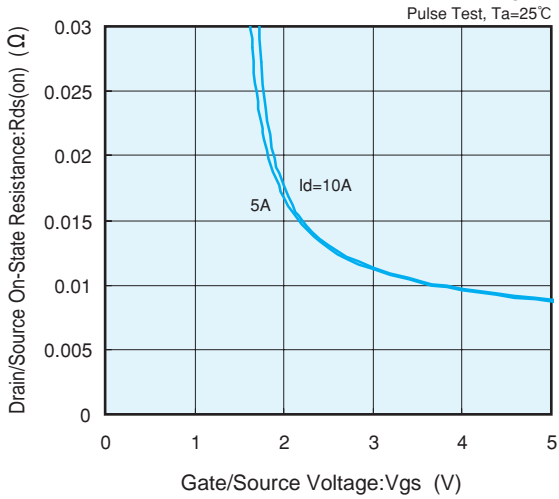

Drain/Source On-State Resistance vs. Drain Current

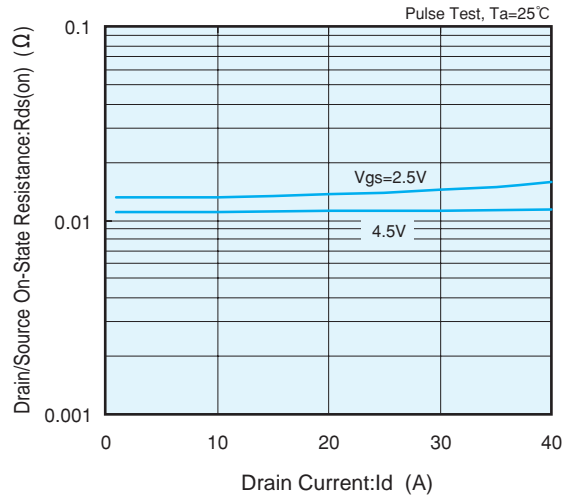

Drain/Source On-State Resistance vs. Ambient Temperature

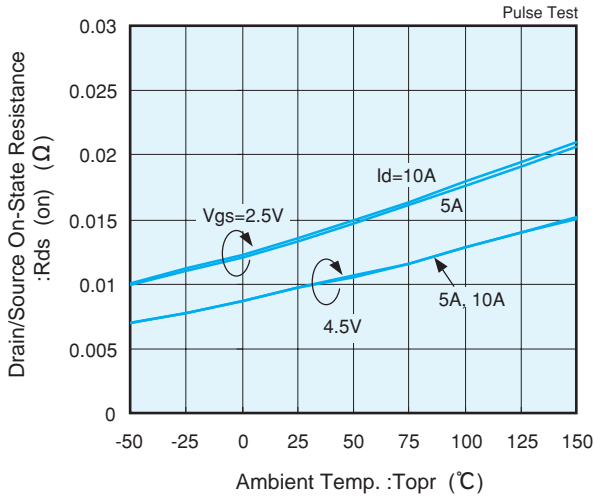

Gate/Source Cut-Off Voltage Variance

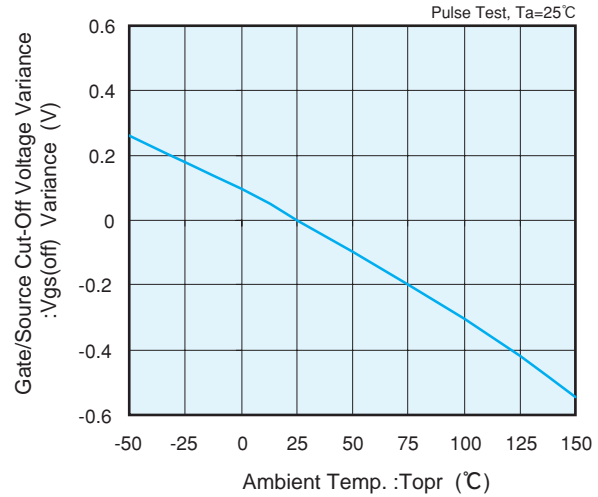

Electrical Characteristics

Drain/Source Voltage vs. Capacitance

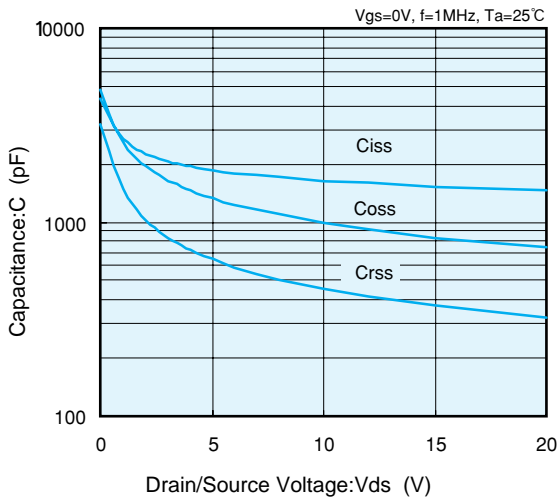

Switching Time vs. Drain Current

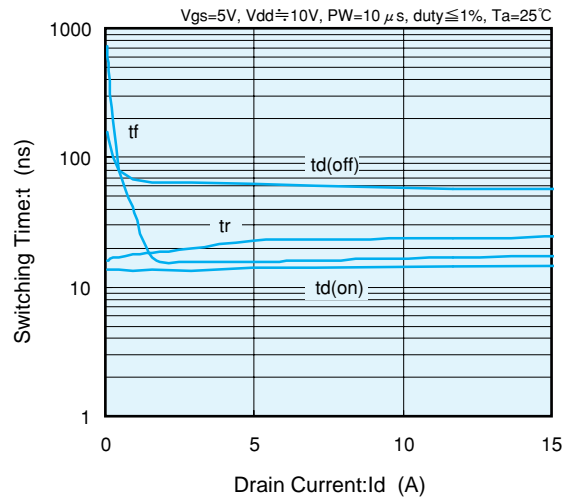

Gate/Source Voltage vs. Gate Charge

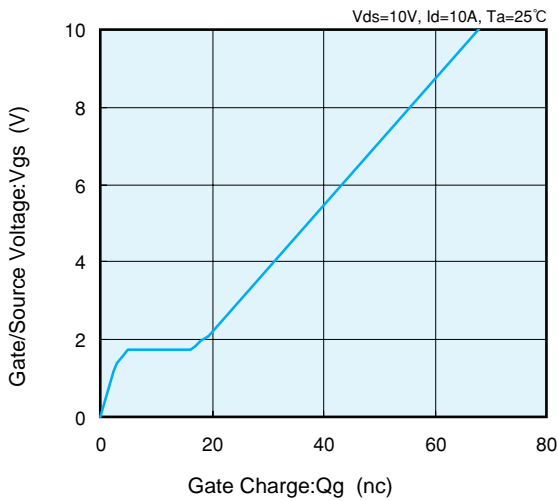

Reverse Drain Current vs. Source/Drain Voltage

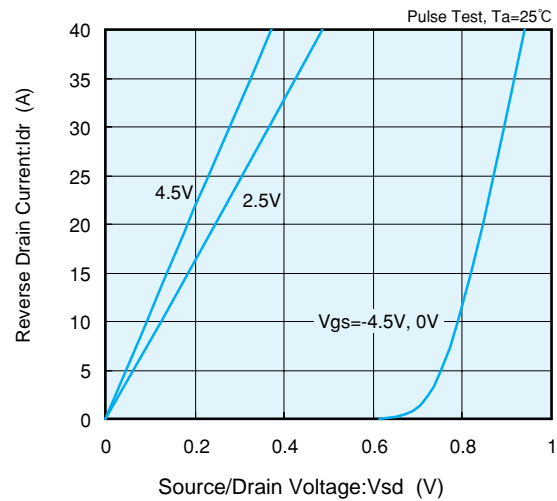

Standardized Transition Thermal Resistance vs. Pulse

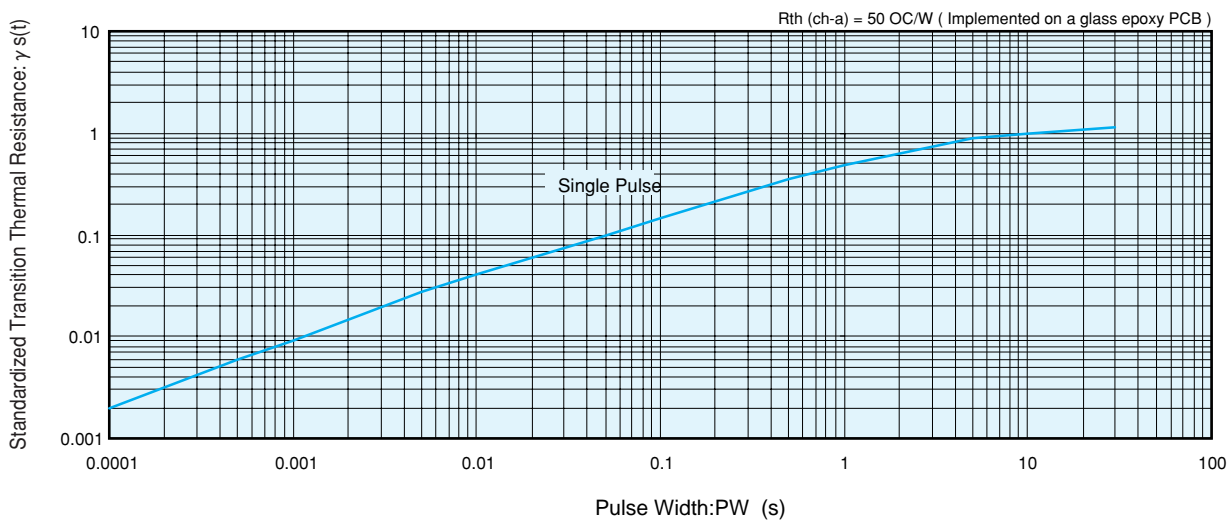

7