

- ◆ N-Channel Power MOS FET
- ◆ DMOS Structure
- ◆ Low On-State Resistance: **0.075Ω MAX**
- ◆ Ultra High-Speed Switching
- ◆ SOP-8 Package
- ◆ Two FET Devices built-in

General Description

The XP133A0175SR is a N-Channel Power MOS FET with low on-state resistance and ultra high-speed switching characteristics. Two FET devices are built into the one package. Because high-speed switching is possible, the IC can be efficiently set thereby saving energy. The small SOP-8 package makes high density mounting possible.

Applications

- Notebook PCs
- Cellular and portable phones
- On-board power supplies
- Li-ion battery systems

Features

Low on-state resistance: $R_{ds(on)}=0.048\Omega(V_{gs}=10V)$
 $R_{ds(on)}=0.075\Omega(V_{gs}=4.5V)$

Ultra high-speed switching

Operational Voltage: 4.5V

High density mounting: SOP-8

Pin Configuration

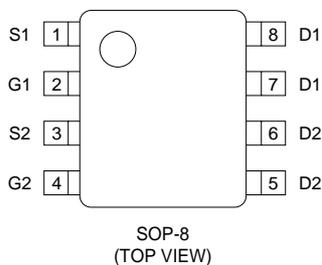

Pin Assignment

PIN NUMBER	PIN NAME	FUNCTION
1	S1	Source
2	G1	Gate
3	S2	Source
4	G2	Gate
5-6	D2	Drain
7-8	D1	Drain

Equivalent Circuit

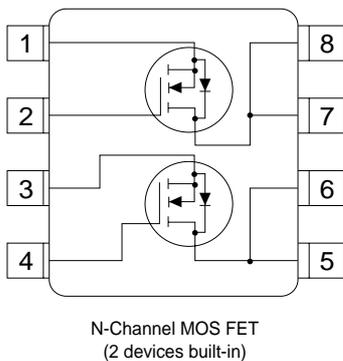

Absolute Maximum Ratings

$T_a=25^\circ C$

PARAMETER	SYMBOL	RATINGS	UNITS
Drain-Source Voltage	V_{dss}	30	V
Gate-Source Voltage	V_{gss}	± 20	V
Drain Current (DC)	I_d	5	A
Drain Current (Pulse)	I_{dp}	15	A
Reverse Drain Current	I_{dr}	5	A
Continuous Channel Power Dissipation (note)	P_d	2	W
Channel Temperature	T_{ch}	150	$^\circ C$
Storage Temperature	T_{stg}	-55~150	$^\circ C$

Note: When implemented on a glass epoxy PCB

Electrical Characteristics

DC characteristics

Ta=25°C

PARAMETER	SYMBOL	CONDITIONS	MIN	TYP	MAX	UNITS
Drain Cut-off Current	Idss	Vds=30V, Vgs=0V			10	μA
Gate-Source Leakage Current	Igss	Vgs=±20V, Vds=0V			±1	μA
Gate-Source Cut-off Voltage	Vgs(off)	Id=1mA, Vds=10V	1.0		2.5	V
Drain-Source On-state Resistance (note)	Rds(on)	Id=3A, Vgs=10V		0.04	0.048	Ω
		Id=3A, Vgs=4.5V		0.06	0.075	Ω
Forward Transfer Admittance (note)	Yfs	Id=3A, Vds=10V		7		S
Body Drain Diode Forward Voltage	Vf	If=5A, Vgs=0V		0.85	1.1	V

Note: Effective during pulse test.

Dynamic characteristics

Ta=25°C

PARAMETER	SYMBOL	CONDITIONS	MIN	TYP	MAX	UNITS
Input Capacitance	Ciss	Vds=10V, Vgs=0V f=1MHz		520		pF
Output Capacitance	Coss			340		pF
Feedback Capacitance	Crss			130		pF

7

Switching characteristics

Ta=25°C

PARAMETER	SYMBOL	CONDITIONS	MIN	TYP	MAX	UNITS	
Turn-on Delay Time	td (on)	Vgs=5V, Id=3A Vdd=10V		15		ns	
Rise Time	tr			20		ns	
Turn-off Delay Time	td (off)				25		ns
Fall Time	tf				15		ns

Thermal characteristics

PARAMETER	SYMBOL	CONDITIONS	MIN	TYP	MAX	UNITS
Thermal Resistance (channel-surroundings)	Rth (ch-a)	Implement on a glass epoxy resin PCB		62.5		°C/W

Electrical Characteristics

Drain Current vs. Drain /Source Voltage

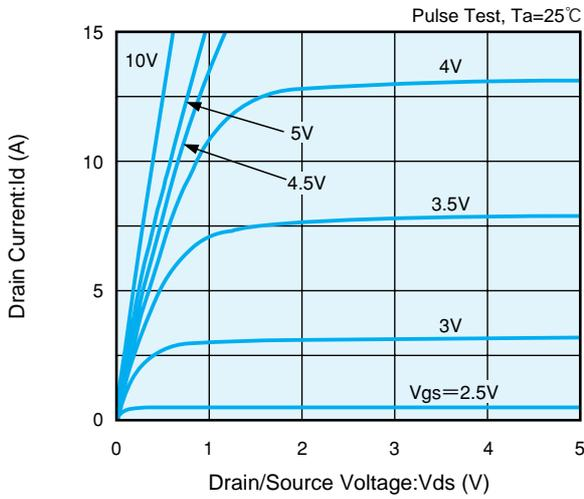

Drain Current vs. Gate/Source Voltage

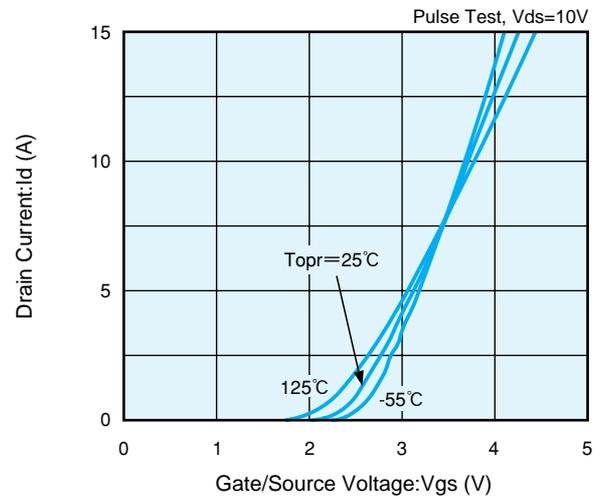

Drain/Source On-State Resistance vs. Gate/Source Voltage

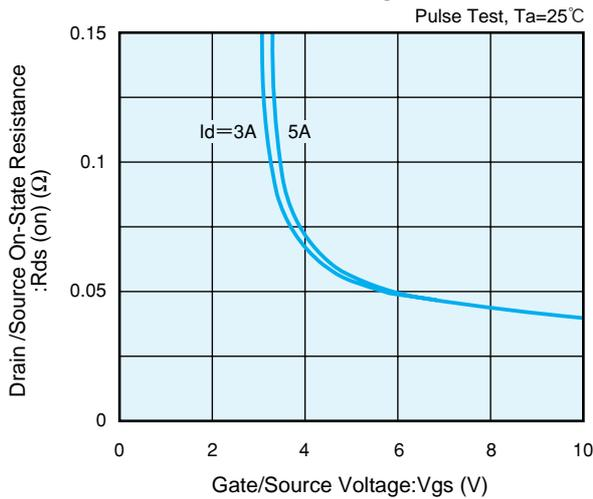

Drain/Source On-State Resistance vs. Drain Current

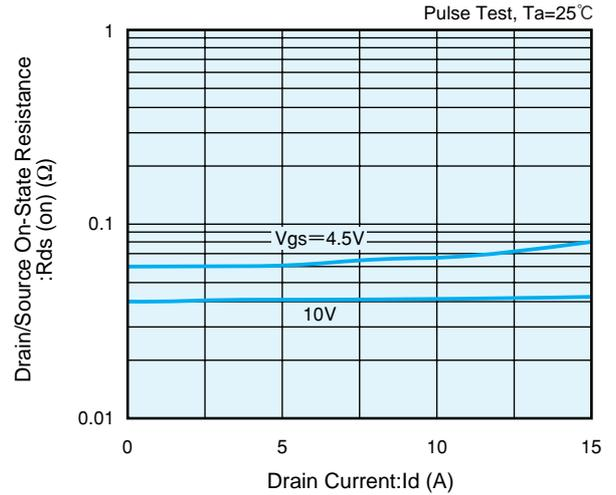

Drain/Source On-State Resistance vs. Ambient Temp.

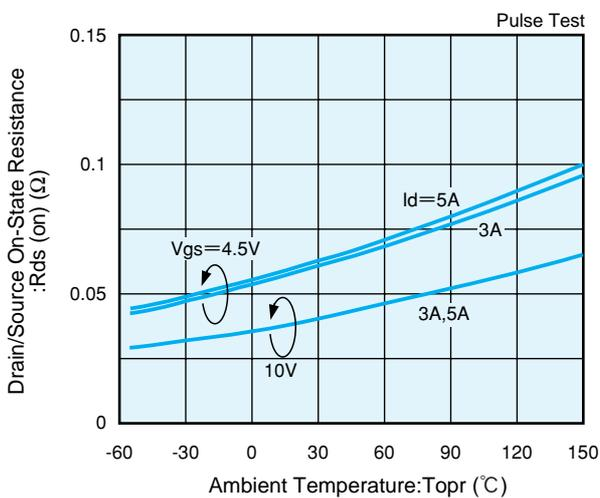

Gate/Source Cut Off Voltage Variance vs. Ambient Temp.

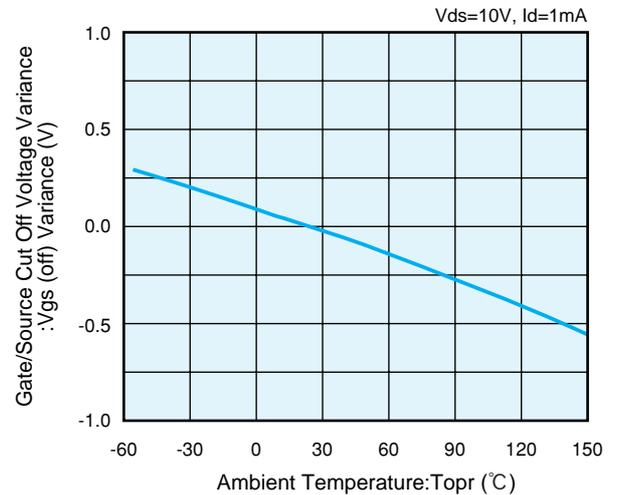

Electrical Characteristics

Drain/Source Voltage vs. Capacitance

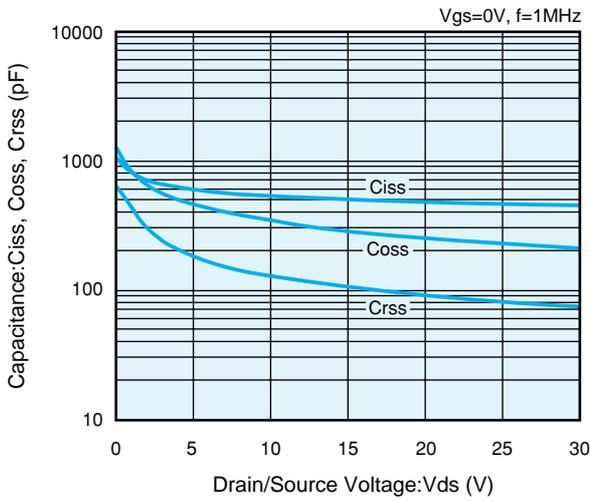

Switching Time vs. Drain Current

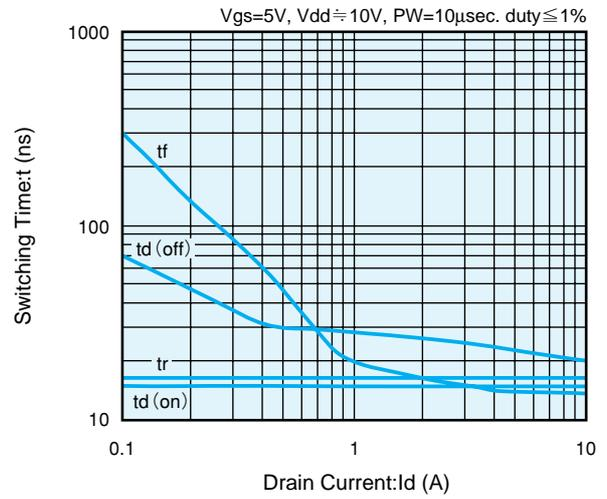

Gate/Source Voltage vs. Gate Charge

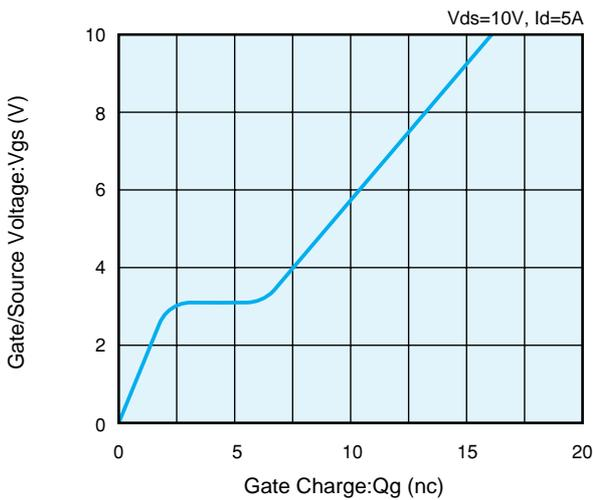

Reverse Drain Current vs. Source/Drain Voltage

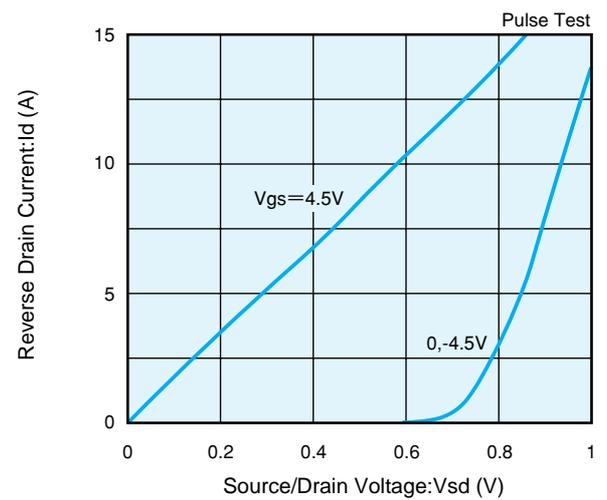

Standardized Transition Thermal Resistance vs. Pulse Width

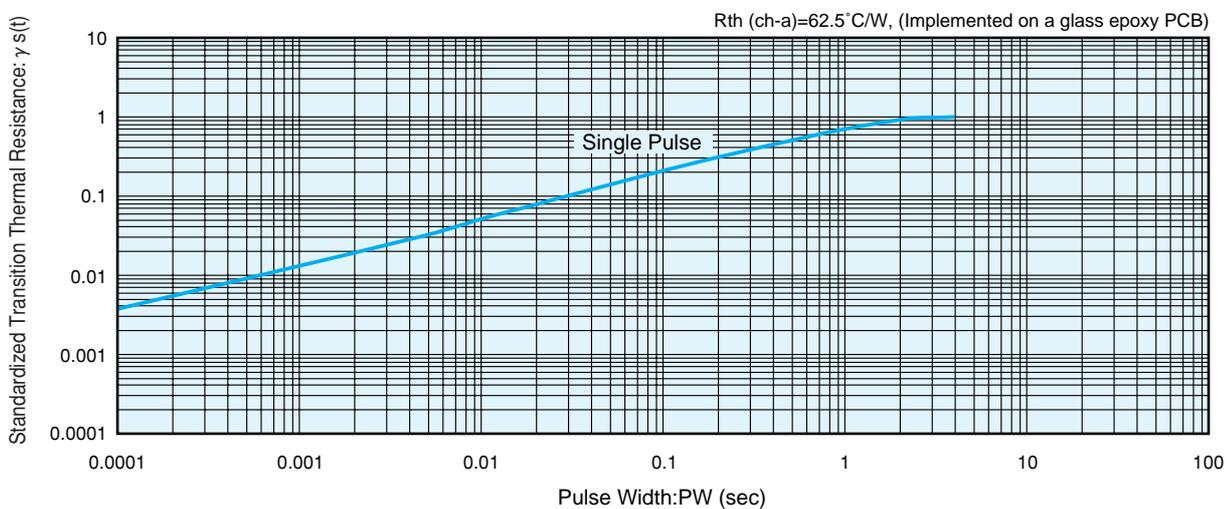

7