

TOSHIBA FIELD EFFECT TRANSISTOR SILICON P CHANNEL MOS TYPE (L²-π-MOSV)

2SJ401

HIGH SPEED, HIGH CURRENT SWITCHING APPLICATIONS

DC-DC CONVERTER, RELAY DRIVE AND MOTOR DRIVE APPLICATIONS

- 4 V Gate Drive
- Low Drain-Source ON Resistance : $R_{DS(ON)} = 33 \text{ m}\Omega$ (Typ.)
- High Forward Transfer Admittance : $|Y_{fs}| = 20 \text{ S}$ (Typ.)
- Low Leakage Current : $I_{DSS} = 100 \mu\text{A}$ (Max.) ($V_{DS} = -60 \text{ V}$)
- Enhancement-Mode : $V_{th} = -0.8 \sim -2.0 \text{ V}$
($V_{DS} = -10 \text{ V}$, $I_D = -1 \text{ mA}$)

MAXIMUM RATINGS ($T_a = 25^\circ\text{C}$)

CHARACTERISTIC		SYMBOL	RATING	UNIT
Drain-Source Voltage		V_{DSS}	-60	V
Drain-Gate Voltage ($R_{GS} = 20 \text{ k}\Omega$)		V_{DGR}	-60	V
Gate-Source Voltage		V_{GSS}	± 20	V
Drain Current	DC	I_D	-20	A
	Pulse	I_{DP}	-80	A
Drain Power Dissipation ($T_c = 25^\circ\text{C}$)		P_D	100	W
Single Pulse Avalanche Energy**		E_{AS}	800	mJ
Avalanche Current		I_{AR}	-20	A
Repetitive Avalanche Energy*		E_{AR}	10	mJ
Channel Temperature		T_{ch}	150	$^\circ\text{C}$
Storage Temperature Range		T_{stg}	-55~150	$^\circ\text{C}$

HERMAL CHARACTERISTICS

CHARACTERISTIC	SYMBOL	MAX.	UNIT
Thermal Resistance, Channel to Case	$R_{th(ch-c)}$	1.25	$^\circ\text{C} / \text{W}$
Thermal Resistance, Channel to Ambient	$R_{th(ch-a)}$	83.3	$^\circ\text{C} / \text{W}$

Note ;

* Repetitive rating ; Pulse Width Limited by Max. junction temperature.

** $V_{DD} = -50 \text{ V}$, Starting $T_{ch} = 25^\circ\text{C}$, $L = 1.44 \text{ mH}$
 $R_G = 25 \Omega$, $I_{AR} = -20 \text{ A}$

**This transistor is an electrostatic sensitive device.
Please handle with caution.**

INDUSTRIAL APPLICATIONS
TO-220FL Unit in mm

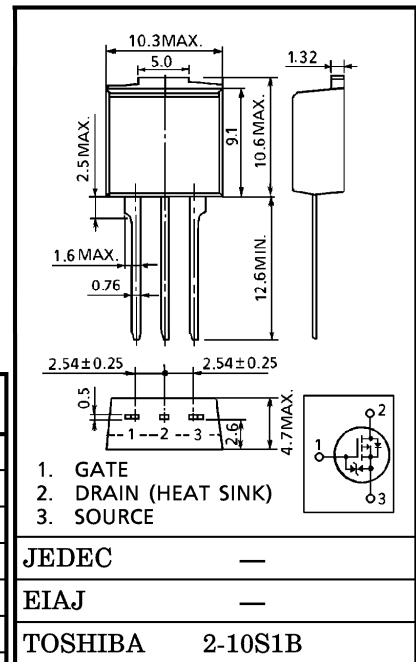

TO-220SM Unit in mm

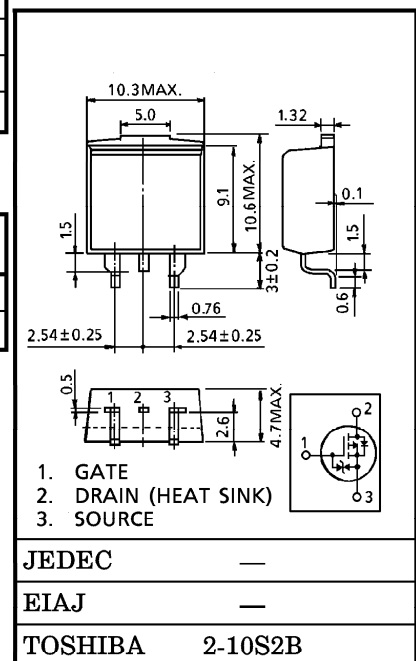

Weight : 1.5 g

961001EAA2

● TOSHIBA is continually working to improve the quality and the reliability of its products. Nevertheless, semiconductor devices in general can malfunction or fail due to their inherent electrical sensitivity and vulnerability to physical stress. It is the responsibility of the buyer, when utilizing TOSHIBA products, to observe standards of safety, and to avoid situations in which a malfunction or failure of a TOSHIBA product could cause loss of human life, bodily injury or damage to property. In developing your designs, please ensure that TOSHIBA products are used within specified operating ranges as set forth in the most recent products specifications. Also, please keep in mind the precautions and conditions set forth in the TOSHIBA Semiconductor Reliability Handbook.

● The information contained herein is presented only as a guide for the applications of our products. No responsibility is assumed by TOSHIBA CORPORATION for any infringements of intellectual property or other rights of the third parties which may result from its use. No license is granted by implication or otherwise under any intellectual property or other rights of TOSHIBA CORPORATION or others.

● The information contained herein is subject to change without notice.

ELECTRICAL CHARACTERISTICS (Ta = 25°C)

CHARACTERISTIC	SYMBOL	TEST CONDITION	MIN.	TYP.	MAX.	UNIT	
Gate Leakage Current	IGSS	VGS = ±16 V, VDS = 0 V	—	—	±10	μA	
Drain Cut-off Current	IDSS	VDS = -60 V, VGS = 0 V	—	—	-100	μA	
Drain-Source Breakdown Voltage	V(BR) DSS	ID = -10 mA, VGS = 0 V	-60	—	—	V	
Gate Threshold Voltage	Vth	VDS = -10 V, ID = -1 mA	-0.8	—	-2.0	V	
Drain-Source ON Resistance	RDS(ON)	VGS = -4 V, ID = -10 A	—	50	90	mΩ	
		VGS = -10 V, ID = -10 A	—	33	45		
Forward Transfer Admittance	Yfs	VDS = -10 V, ID = -10 A	10	20	—	S	
Input Capacitance	Ciss	VDS = 10 V, VGS = 0 V, f = 1 MHz	—	2800	—	pF	
Reverse Transfer Capacitance	Crss		—	450	—		
Output Capacitance	Coss		—	1300	—		
Switching Time	Rise Time	tr		—	15	—	ns
	Turn-on Time	ton		—	35	—	
	Fall Time	tf		—	25	—	
	Turn-off Time	t _{off}		VIN : tr, tf < 5 ns Duty ≤ 1%, tw = 10 μs VDD ≐ -30 V	—	120	
Total Gate Charge (Gate-Source Plus Gate-Drain)	Qg	VDD ≐ -48 V, VGS = -10 V	—	90	—	nC	
Gate-Source Charge	Qgs	ID = -20 A	—	65	—		
Gate-Drain ("Miller") Charge	Qgd		—	25	—		

SOURCE-DRAIN DIODE RATINGS AND CHARACTERISTICS (Ta = 25°C)

CHARACTERISTIC	SYMBOL	TEST CONDITION	MIN.	TYP.	MAX.	UNIT
Continuous Drain Reverse Current	IDR	—	—	—	-20	A
Pulse Drain Reverse Current	IDRP	—	—	—	-80	A
Diode Forward Voltage	VDSF	IDR = -20 A, VGS = 0 V	—	—	1.7	V
Reverse Recovery Time	t _{rr}	IDR = -20 A, VGS = 0 V	—	75	—	ns
Reverse Recovery Charge	Q _{rr}	dIDR / dt = -50 A / μs	—	83	—	nC

MARKING

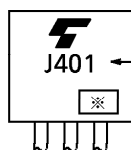

← TYPE

※ Lot Number

□ □ — Month (Starting from Alphabet A)

— Year (Last Number of the Christian Era)

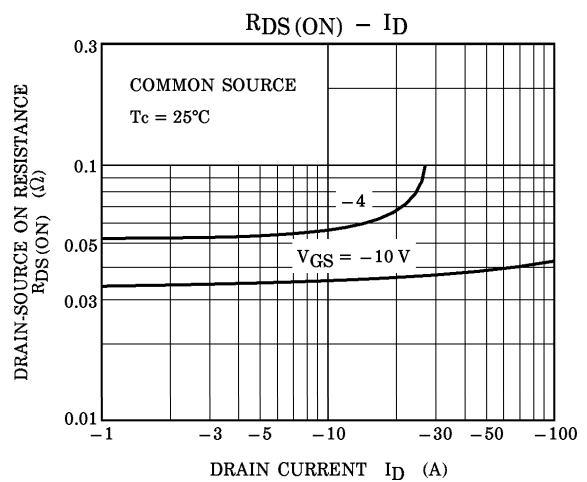
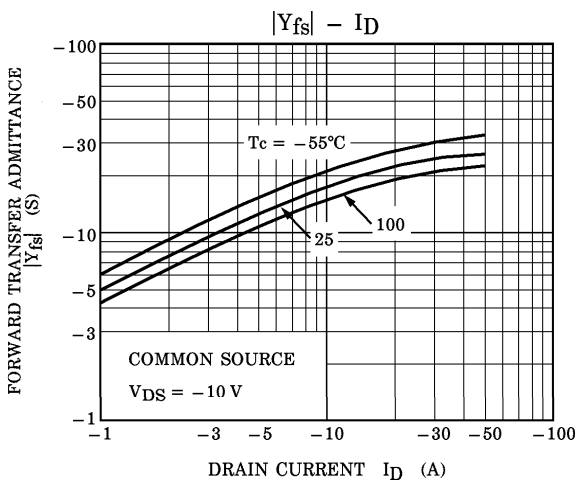
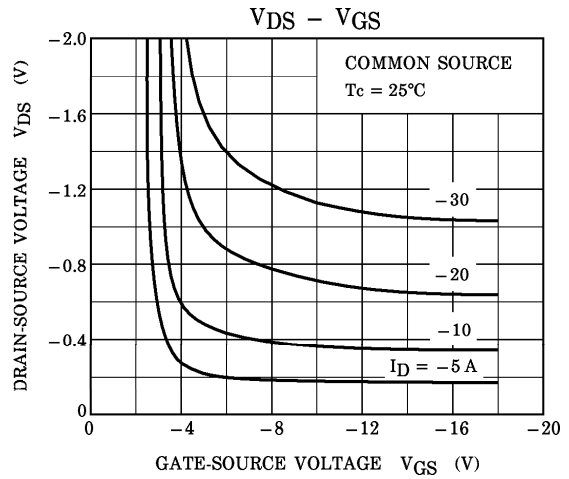
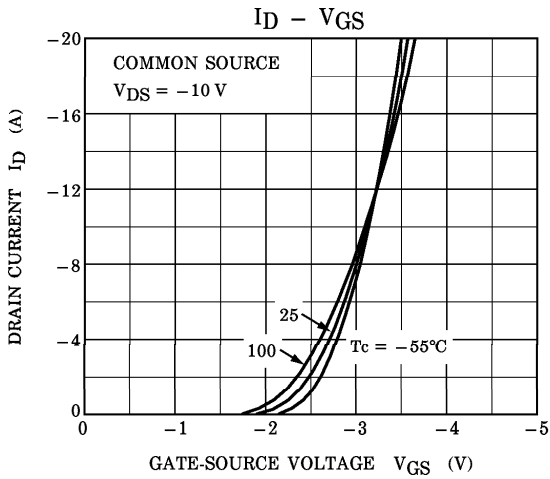
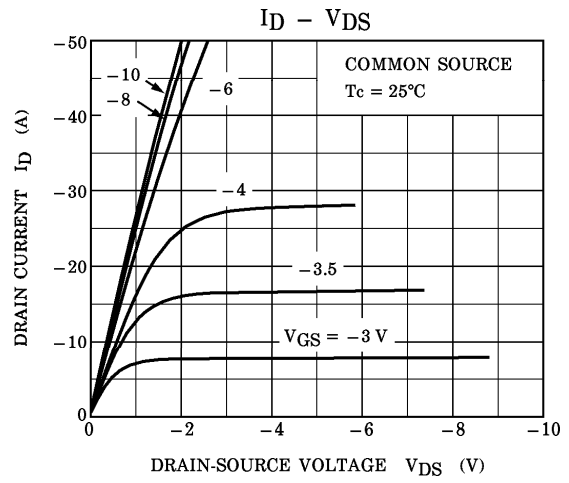
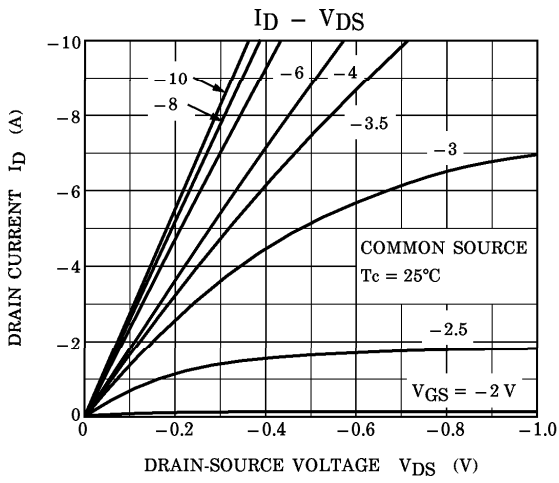

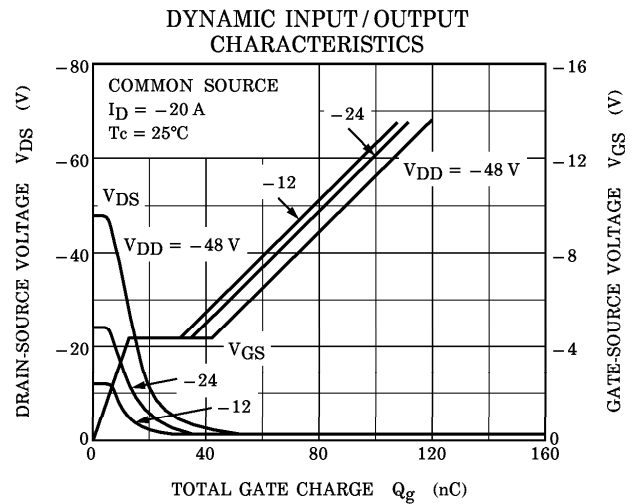
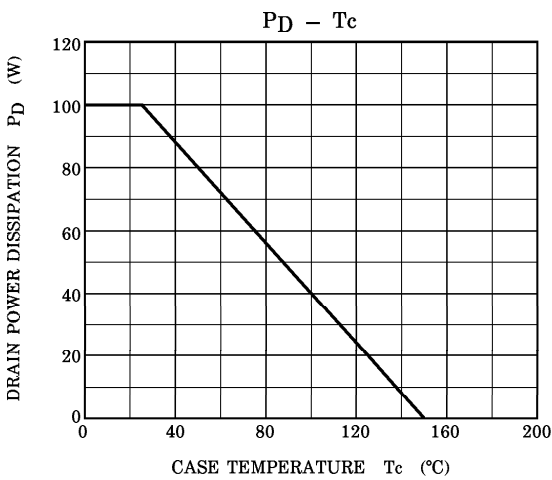
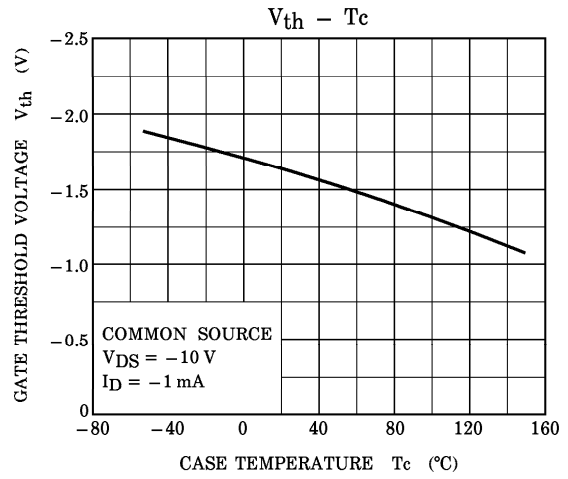
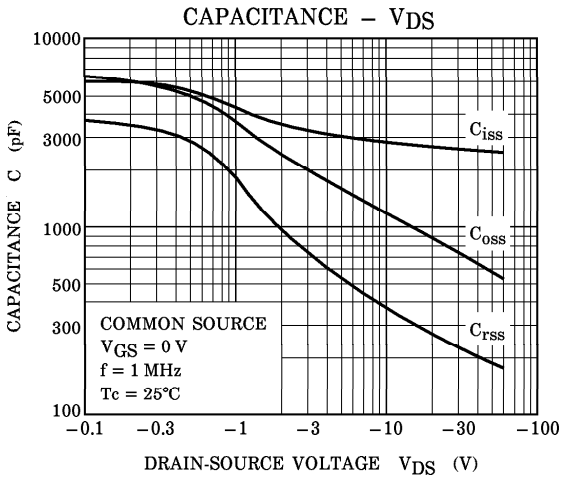
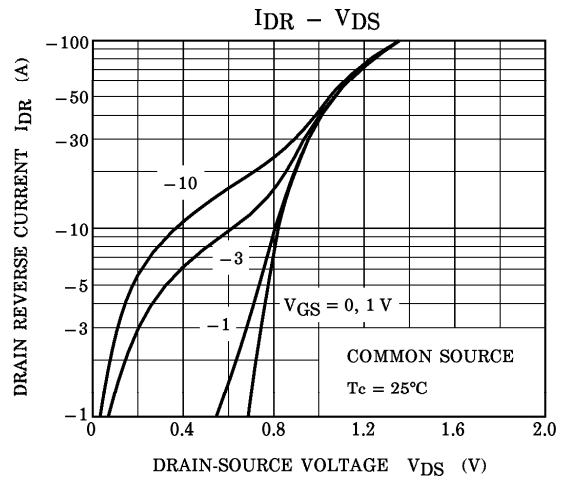
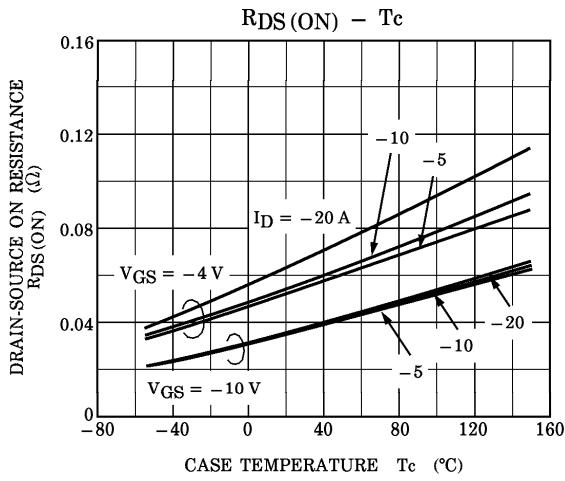

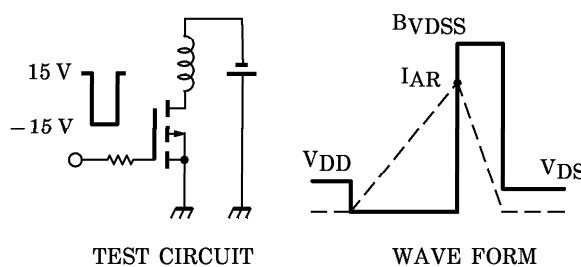
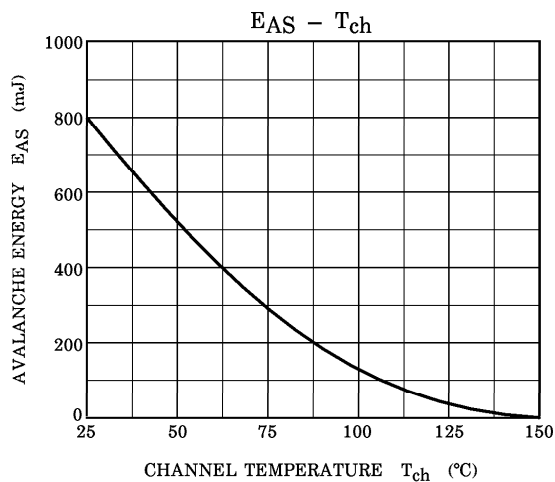
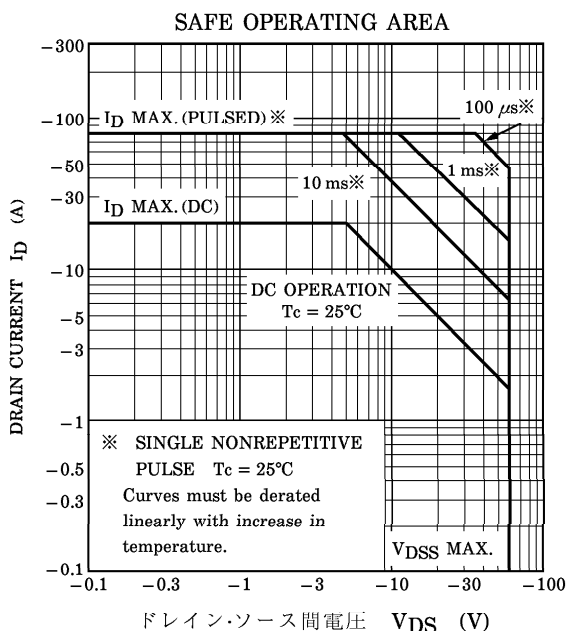
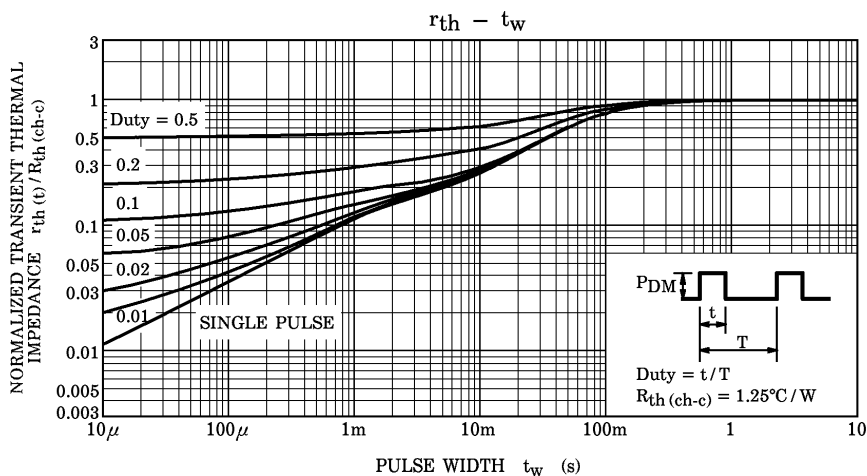

Peak $I_{AR} = -20 A$, $R_G = 25 \Omega$, $V_{DD} = -50 V$, $L = 1.44 mH$

$$E_{AS} = \frac{1}{2} \cdot L \cdot I^2 \cdot \left(\frac{BVDSS}{BVDSS - V_{DD}} \right)$$