

TGF4230-EEU

1.2mm Discrete HFET

# 4230

- **1200  $\mu\text{m}$  X 0.5  $\mu\text{m}$  HFET**
- **Nominal Pout of 28.5-dBm at 8.5-GHz**
- **Nominal Gain of 10.0-dB at 8.5-GHz**
- **Nominal PAE of 55% at 8.5-GHz**
- **Suitable for High-Reliability Applications**
- **0,572 x 0,699 x 0,102 mm (0.023 x 0.028 x 0.004 in.)**

**PHOTO ENLARGEMENT**

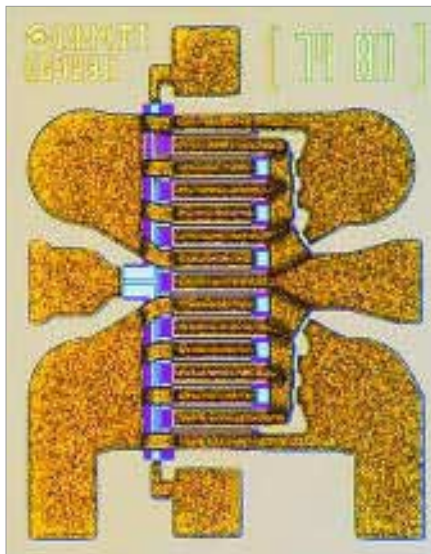

**DESCRIPTION**

The Triquint TGF4230 -EEU is a single gate 1.2 mm Discrete GaAs Heterostructure Field Effect Transistor (HFET) designed for high-efficiency power applications up to 1.2 GHz in Class A and Class AB operation.

Bond-pad and backside metalization is gold plated for compatibility with eutectic alloy attach methods as well as thermocompression and thermosonic wire-bonding processes. The TGF4230-EEU is readily assembled using automatic equipment.

**EXAMPLE OF DC I-V CURVES**

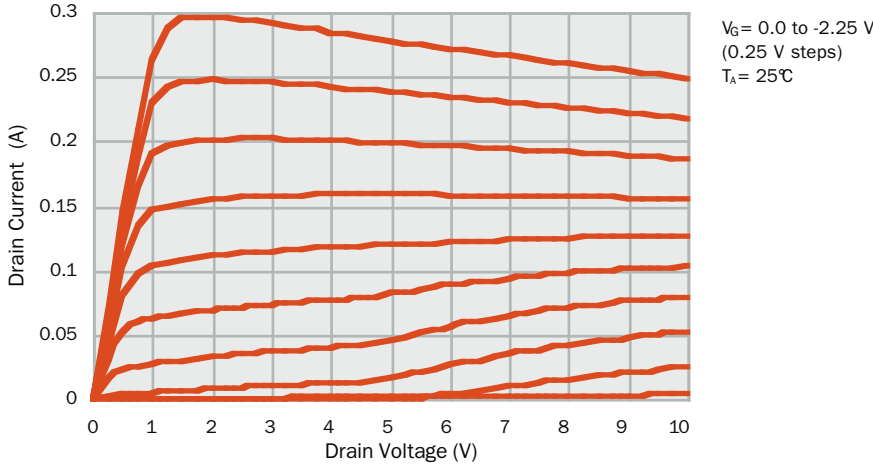

**OUTPUT POWER VS. INPUT POWER**

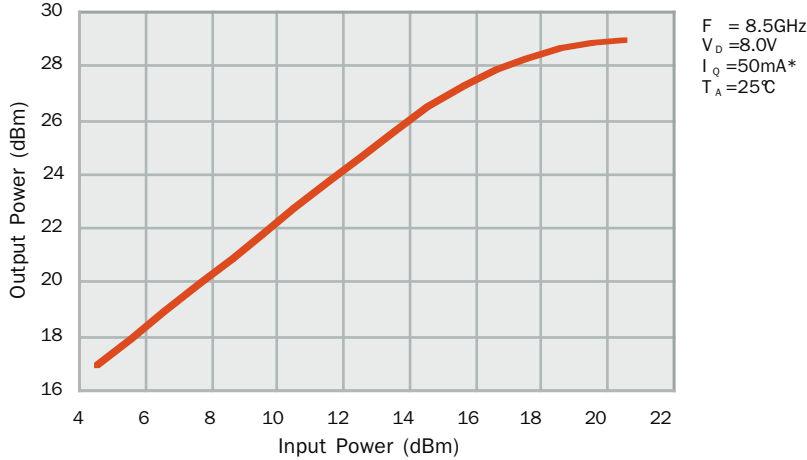

Note:  $I_Q$  is defined as the drain current before application of RF signal at the input.

**POWER ADDED EFFICIENCY VS. INPUT POWER**

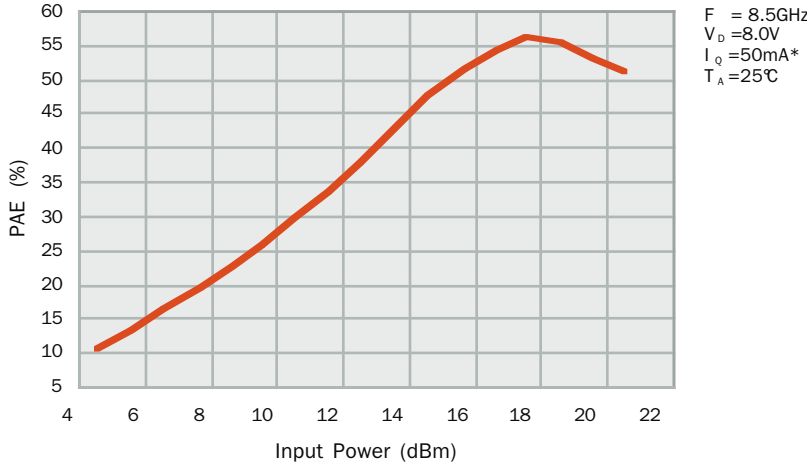

**GAIN VS. INPUT POWER**

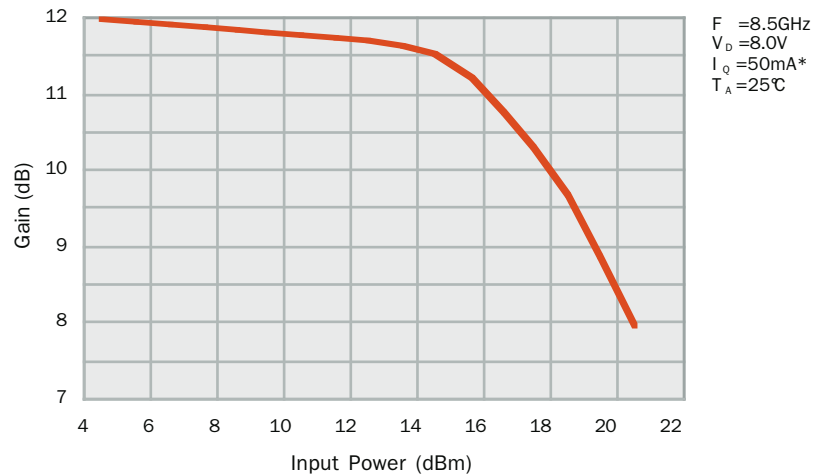

**DRAIN CURRENT VS. INPUT POWER**

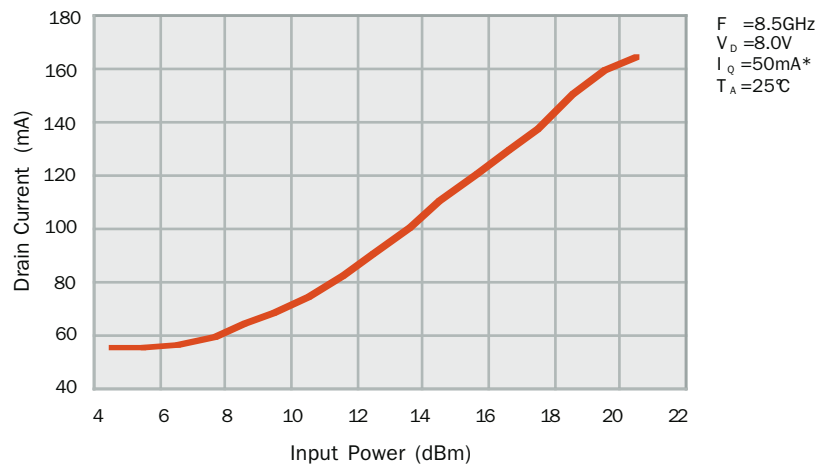

**ABSOLUTE MAXIMUM RATINGS**

Drain-to-source Voltage, $V_{DS}$ .....	12 V
Gate-to-source Voltage, $V_{GS}$ .....	-5 V to 0 V
Mounting temperature (30 sec), $T_M$ .....	320 °C
Storage temperature range, $T_{STG}$ .....	-65 to 200 °C
Power dissipation, $P_D$ .....	(see thermal data on next page)
Operating channel temperature, $T_{CH}$ .....	(see thermal data on next page)

**Ratings over base-plate temperature range  $T_{BP}$  (unless otherwise noted)**

Stresses beyond those listed under “Absolute Maximum Ratings” may cause permanent damage to the device. These are stress ratings only, and functional operation of the device at these or any other conditions beyond those indicated “RF and DC Characteristics” is not implied. Exposure to absolute maximum rated conditions for extended periods of time may affect device reliability.

**PREDICTED CHANNEL TEMPERATURE VS. BASE TEMPERATURE**  
at 0.51 W and 1.02 W  
dissipated power

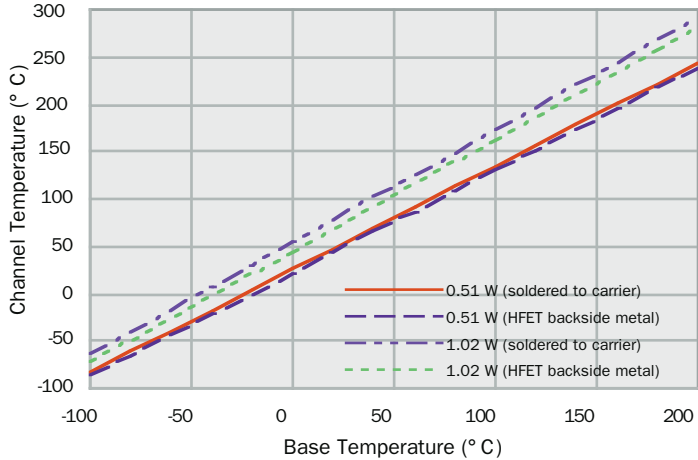

Case 1: Base temperature at backside of carrier (with 38 m AuSn solder attach to 0.5 mm CuMo Carrier).  
Case 2: Base temperature at backside of 1.2 mm HFET .

**HFET CHANNEL TEMPERATURE VS. MEDIAN LIFE**

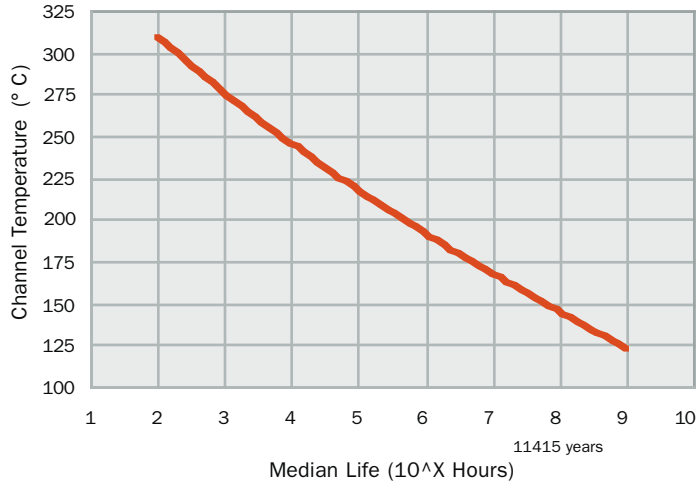

**RF AND DC CHARACTERISTICS**

	PARAMETER	MIN	NOMINAL	MAX	UNIT
P <sub>out</sub>	Output Power	27.5	28.5	-	dBm
G <sub>P</sub>	Power Gain	8	10	-	dB
PAE	Power Added Efficiency	50	55	-	%
I <sub>DSS</sub>	Drain Saturation Current	204	294	384	mA
G <sub>M</sub>	Transconductance	144	198	252	mS
V <sub>P</sub>	Pinch Off Voltage	-2.7	-1.85	-1	V
BV <sub>GS</sub>	Breakdown Voltage Gate-Source	-30	-22	-17	V
BV <sub>GD</sub>	Breakdown Voltage Gate-Drain	-30	-22	-17	V

**Pout, Gain, and PAE:** Measured at 8.5 GHz, drain voltage of 8.0 V. Gate voltage is adjusted to achieve quiescent current of approximately 20% I<sub>DSS</sub> with no RF signal applied. The source is grounded. Input power between 18 and 19-dBm.

**I<sub>DSS</sub>:** **Saturated drain-source current.** Search for the maximum I<sub>DS</sub> at V<sub>GS</sub> = 0.0 V, and V<sub>DS</sub> swept between 0.5 V to 3.5 V. Note that the drain voltage at which I<sub>DSS</sub> is located and recorded as V<sub>DSP</sub>.

**G<sub>M</sub>:** **Transconductance.** (I<sub>DSS</sub> - I<sub>DS1</sub>) / |V<sub>G1</sub>|. I<sub>DS1</sub> measured at V<sub>G1</sub> = -0.25 V using the knee search technique; V<sub>DS</sub> swept between 0.5 V and V<sub>DSP</sub> to search for maximum I<sub>DS1</sub>.

**V<sub>P</sub>:** **Pinch off voltage.** V<sub>GS</sub> for I<sub>DS</sub> = 0.5 mA/mm of gate width. V<sub>DS</sub> fixed at 2.0 V, V<sub>GS</sub> swept to bring I<sub>DS</sub> to 0.5 mA/mm. Sweep will stop if V<sub>P</sub> current not found beyond 0.5 V of the minimum V<sub>P</sub> specification.

**BV<sub>GS</sub>:** **Breakdown voltage, gate to source.** I<sub>BD</sub> = 1.0 mA/mm of gate width. Source fixed at ground, drain not connected (floating). When 1.0mA/mm drawn at gate, V<sub>GS</sub> measured as BV<sub>GS</sub>.

**BV<sub>GD</sub>:** **Breakdown voltage, gate to drain.** I<sub>BD</sub> = 1.0 mA/mm of gate width. Drain fixed at ground, source not connected (floating). When 1.0 mA/mm drawn at the gate, V<sub>GD</sub> measured as BV<sub>GD</sub>.

**LINEAR MODEL**

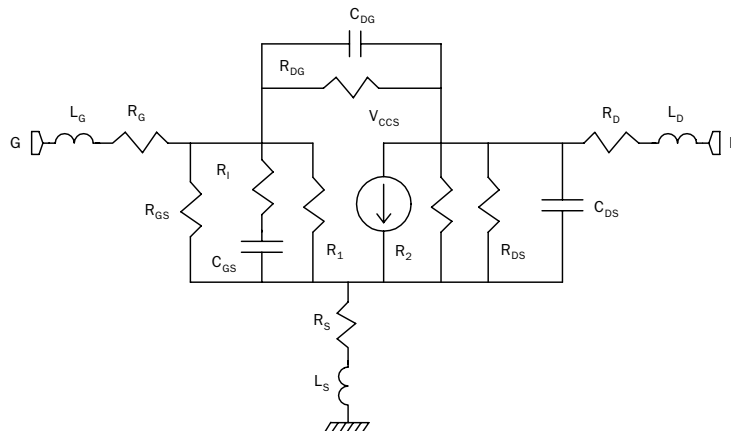

V<sub>DS</sub> = 8.0 V and 30% I<sub>DSS</sub> at T = 25°C

**FET Elements**

L<sub>G</sub> = 0.0421 nH  
 R<sub>G</sub> = 0.43  
 R<sub>GS</sub> = 81700  
 R<sub>1</sub> = 1.21  
 C<sub>GS</sub> = 1.21 pF  
 C<sub>DG</sub> = 0.1004 pF

R<sub>DG</sub> = 204000

R<sub>S</sub> = 0.4  
 L<sub>S</sub> = 0.015 nH  
 R<sub>DS</sub> = 98.01  
 C<sub>DS</sub> = 0.25325 pF  
 R<sub>D</sub> = 0.66  
 L<sub>D</sub> = 0.022 nH

**VCCS Parameters**

M = 132.9 mS  
 A = 0  
 R1 = 1E19  
 R2 = 1E19  
 F = 0  
 T = 5.49 pS

## MODELED S-PARAMETERS

Frequency (GHz)	S <sub>11</sub>		S <sub>21</sub>		S <sub>12</sub>		S <sub>22</sub>	
	MAG	ANG(°)	MAG	ANG(°)	MAG	ANG(°)	MAG	ANG(°)
0.5	0.985	-29.88	8.095	161.49	0.021	72.66	0.343	-22.22
1.0	0.959	-56.20	7.297	145.18	0.038	58.80	0.328	-41.75
1.5	0.931	-77.47	6.368	131.86	0.050	47.65	0.312	-57.46
2.0	0.908	-94.02	5.512	121.22	0.057	39.12	0.301	-69.57
2.5	0.891	-106.82	4.791	112.62	0.062	32.60	0.295	-78.80
3.0	0.880	-116.82	4.202	105.49	0.065	27.55	0.294	-85.89
3.5	0.871	-124.76	3.723	99.42	0.067	23.56	0.297	-91.41
4.0	0.865	-131.19	3.330	94.11	0.068	20.34	0.302	-95.80
4.5	0.861	-136.48	3.004	89.37	0.069	17.70	0.309	-99.38
5.0	0.858	-140.92	2.732	85.06	0.069	15.51	0.319	-102.37
5.5	0.856	-144.69	2.501	81.09	0.069	13.67	0.329	-104.94
6.0	0.855	-147.94	2.304	77.39	0.068	12.12	0.340	-107.18
6.5	0.854	-150.78	2.133	73.90	0.068	10.82	0.352	-109.19
7.0	0.854	-153.29	1.984	70.59	0.067	9.72	0.364	-111.03
7.5	0.854	-155.53	1.852	67.43	0.066	8.80	0.377	-112.73
8.0	0.855	-157.54	1.736	64.40	0.065	8.05	0.390	-114.32
8.5	0.855	-159.37	1.632	61.49	0.065	7.45	0.404	-115.84
9.0	0.856	-161.04	1.539	58.67	0.064	7.00	0.417	-117.29
9.5	0.857	-162.58	1.455	55.95	0.063	6.68	0.430	-118.68
10.0	0.858	-164.01	1.378	53.30	0.061	6.49	0.444	-120.03
10.5	0.859	-165.34	1.308	50.73	0.060	6.43	0.457	-121.35
11.0	0.860	-166.58	1.244	48.23	0.059	6.51	0.470	-122.63
11.5	0.862	-167.76	1.186	45.79	0.058	6.71	0.483	-123.89
12.0	0.863	-168.87	1.131	43.41	0.057	7.05	0.496	-125.11
12.5	0.864	-169.93	1.081	41.09	0.056	7.52	0.509	-126.32
13.0	0.866	-170.94	1.034	38.83	0.055	8.12	0.521	-127.51
13.5	0.867	-171.91	0.991	36.62	0.053	8.86	0.534	-128.68
14.0	0.869	-172.84	0.950	34.46	0.052	9.74	0.546	-129.82

V<sub>DS</sub> = 8.0 V and 30% I<sub>DSS</sub> at T = 25°C

**MECHANICAL DRAWING**

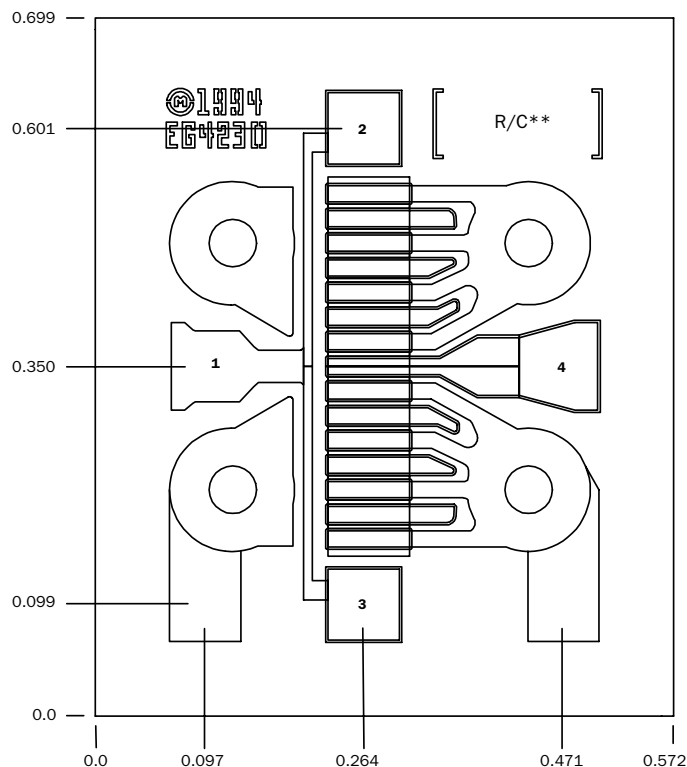

Units: Millimeters  
 Thickness: 0.102  
 Chip size  $\pm$  0.0508

Bond pad 1 (gate): 0.072 x 0.075  
 Bond pad 2 (gate): 0.075 x 0.075\*  
 Bond pad 3 (gate): 0.075 x 0.075\*  
 Bond pad 4 (drain): 0.083 x 0.077

Minimum connections to Bond Pads 1 and 4. Sources are connected to backside metalization.

\* Alternate gate pads used for paralleling TGF4230s or for multiple gate wires.

\*\* Wafer unique Row/Column data is recorded in brackets.

**NOTES**

Gate bias supplies should be designed to sink or source gate current. The magnitude and direction of the gate current is a function of bias point, load impedance, and drive level.