

Gain Block Amplifier

TGA8161-SCC

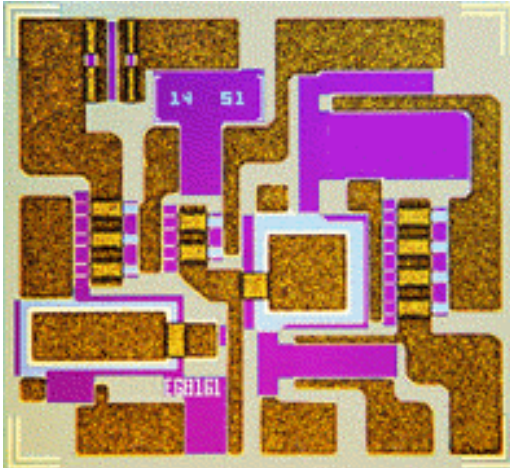

Key Features and Performance

- 500 MHz to 3 GHz Frequency Range
- 19 dB Gain with 3.5 dB Noise Figure
- 1.5:1 input/Output SWR
- Operates from Single 12 V Supply
- Greater than 10 dB Flat Gain Control Range
- Unconditionally Stable
- 1.060 x 0.9398 x 0.1524 mm (0.040 x 0.037 x 0.006 in.)

Description

The TriQuint TGA8161-SCC is a monolithic 3-stage general purpose 500 MHz to 3 GHz amplifier designed as a complementary product to the TGA8061-SCC, 0.1 to 3.5 GHz amplifier.

The TGA8161-SCC is a self-biased amplifier with gain control capability, reduced power consumption, and 3 dB bandwidth performance over the 100 MHz to 4 GHz band. Typical output power at 1 dB gain compression is 12 dBm. The TGA8161-SCC is ideal for receiver applications and may be used in gain control or switching applications.

The TGA8161-SCC is supplied in chip form, with backside metallization, for ease of assembly.

**TYPICAL
SMALL-SIGNAL
POWER GAIN**

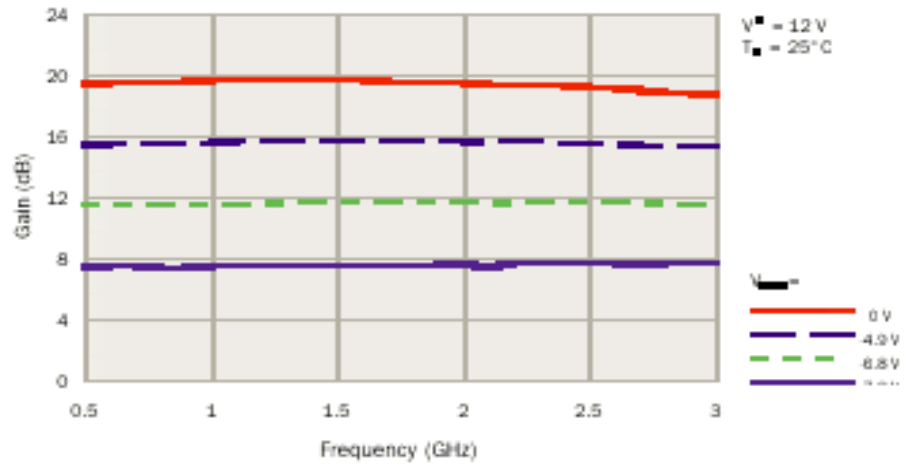

**TYPICAL
NOISE FIGURE**

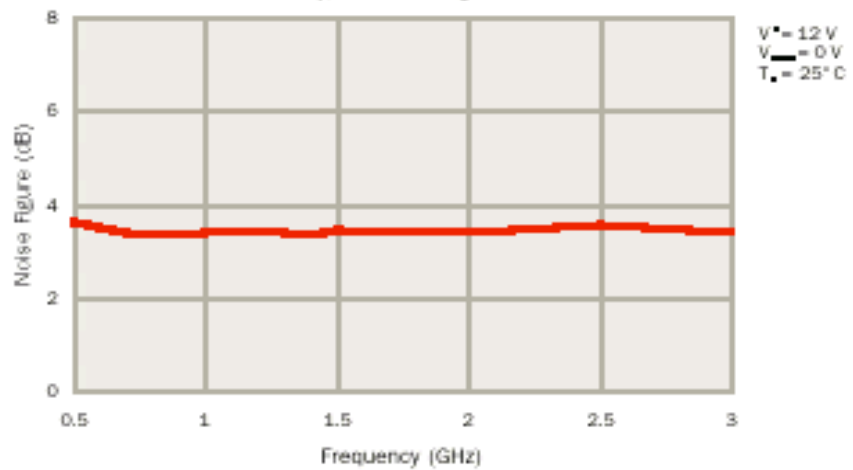

**TYPICAL
OUTPUT POWER
 P_{1dB}**

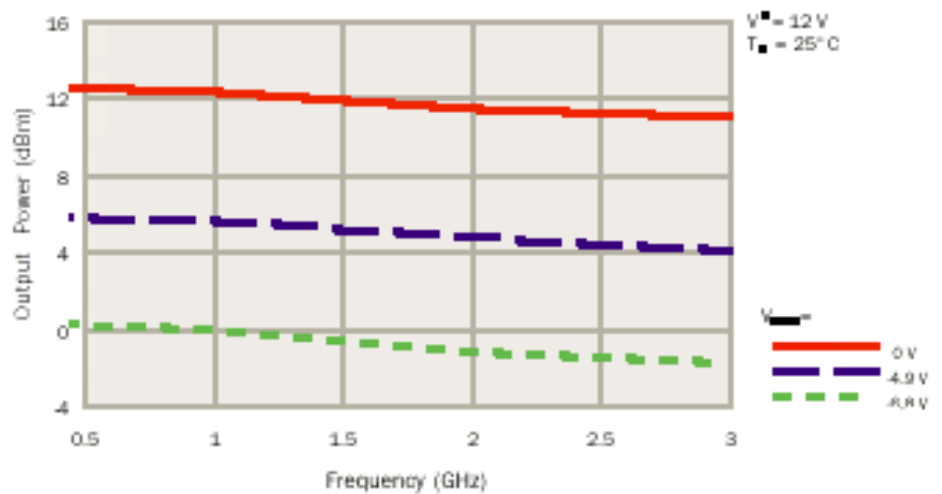

**TYPICAL
RETURN LOSS**

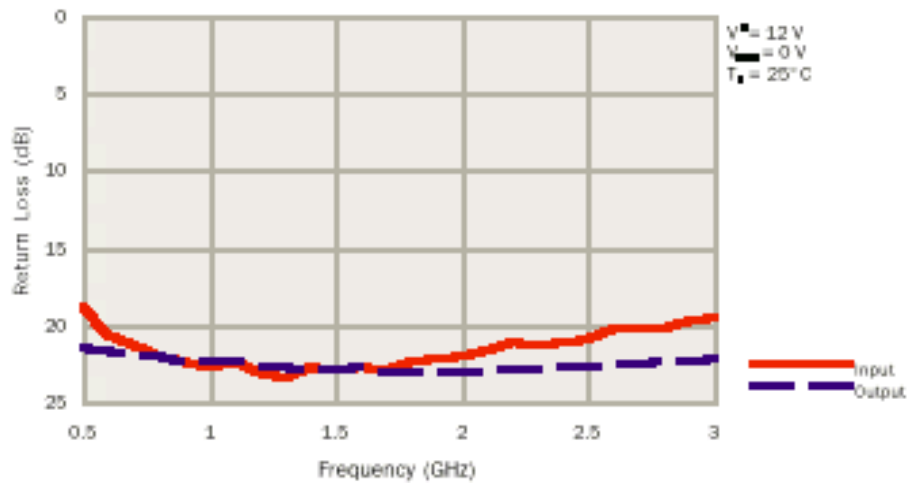

**ABSOLUTE
MAXIMUM RATINGS**

Positive supply voltage, V^+	16 V
Positive supply current, I^+	168 mA
Gain-control voltage range, V_{CTRL}	0 to -12 V
Power dissipation at (or below) 25°C base-plate temperature, P_D^*	2.7 W
Operating channel temperature, T_{CH}^{**}	150°C
Mounting temperature (30 sec), T_M	320°C
Storage temperature range, T_{STG}	-65 to 150°C

Ratings over operating channel temperature range, T_{CH} (unless otherwise noted)

Stresses beyond those listed under "Absolute Maximum Ratings" may cause permanent damage to the device. These are stress ratings only and functional operation of the device at these or any other conditions beyond those indicated under "RF Characteristics" is not implied. Exposure to absolute maximum rated conditions for extended periods may affect device reliability.

* For operation above 25°C base-plate temperature, derate linearly at the rate of 5.7 mW/°C.

** Operating channel temperature (T_{CH}) will directly affect the device MTTF. For maximum life, it is recommended that channel temperature be maintained at the lowest possible level.

TYPICAL S-PARAMETERS

Frequency (GHz)	S ₁₁		S ₂₁		S ₁₂		S ₂₂		GAIN (dB)
	MAG	ANG (°)	MAG	ANG (°)	MAG	ANG (°)	MAG	ANG (°)	
0.1	0.48	-92	5.50	44	0.0120	-75	0.14	-6	14.8
0.2	0.19	-97	7.68	24	0.0044	-90	0.12	-29	17.7
0.3	0.17	-116	8.56	12	0.0024	-93	0.10	-34	18.6
0.4	0.13	-126	8.96	3	0.0014	-87	0.09	-35	19.0
0.5	0.11	-142	9.18	-4	0.0007	-94	0.09	-33	19.3
0.6	0.09	-152	9.32	-10	0.0002	-58	0.08	-35	19.4
0.7	0.09	-158	9.40	-15	0.0002	89	0.08	-37	19.5
0.8	0.08	-173	9.46	-21	0.0007	84	0.08	-40	19.5
0.9	0.08	-178	9.50	-26	0.0010	75	0.08	-43	19.6
1.0	0.07	170	9.53	-30	0.0012	84	0.08	-46	19.6
1.1	0.08	160	9.54	-35	0.0016	81	0.08	-50	19.6
1.2	0.07	151	9.55	-39	0.0018	81	0.07	-53	19.6
1.3	0.07	146	9.56	-44	0.0022	82	0.07	-55	19.6
1.4	0.07	135	9.54	-48	0.0024	85	0.07	-60	19.6
1.5	0.07	128	9.53	-53	0.0027	83	0.07	-63	19.6
1.6	0.07	121	9.51	-57	0.0028	82	0.07	-67	19.6
1.7	0.07	111	9.50	-61	0.0031	83	0.07	-71	19.6
1.8	0.08	105	9.47	-66	0.0033	81	0.07	-76	19.5
1.9	0.08	99	9.43	-70	0.0036	81	0.07	-80	19.5
2.0	0.08	90	9.40	-74	0.0037	80	0.07	-85	19.5
2.1	0.08	84	9.31	-79	0.0040	79	0.07	-89	19.4
2.2	0.09	78	9.28	-83	0.0042	78	0.07	-94	19.4
2.3	0.09	71	9.22	-87	0.0045	78	0.07	-98	19.3
2.4	0.09	65	9.15	-92	0.0047	78	0.07	-104	19.2
2.5	0.09	60	9.07	-96	0.0048	78	0.07	-109	19.1
2.6	0.10	53	8.97	-100	0.0050	77	0.08	-114	19.1
2.7	0.10	47	8.86	-105	0.0052	76	0.08	-118	18.9
2.8	0.10	43	8.77	-109	0.0055	76	0.08	-123	18.9
2.9	0.10	35	8.64	-113	0.0057	74	0.08	-127	18.7
3.0	0.11	29	8.52	-117	0.0058	73	0.08	-131	18.6
3.1	0.11	23	8.41	-122	0.0059	74	0.08	-135	18.5
3.2	0.11	17	8.27	-126	0.0061	74	0.08	-139	18.3
3.3	0.11	11	8.14	-130	0.0062	72	0.08	-143	18.2
3.4	0.12	6	7.99	-135	0.0063	73	0.09	-148	18.1
3.5	0.12	0	7.82	-139	0.0064	72	0.09	-152	17.9
3.6	0.12	-6	7.66	-143	0.0065	72	0.09	-155	17.7
3.7	0.12	-12	7.51	-147	0.0066	69	0.09	-158	17.5
3.8	0.13	-18	7.35	-151	0.0066	72	0.09	-162	17.3
3.9	0.13	-23	7.18	-155	0.0069	70	0.09	-165	17.1
4.0	0.13	-28	7.02	-159	0.0070	72	0.10	-169	16.9

V⁺ = 12 V, V_{CTRL} = 0 V, T_A = 25° C

Reference planes for S-parameter data include bond wires as specified in the "Recommended Assembly Diagram". The S-parameters are also available on floppy disk and the world wide web.

RF CHARACTERISTICS

PARAMETER	TEST CONDITIONS	TYP	UNIT
G_p Small-signal power gain	$f = 0.5$ to 3 GHz	19	dB
ΔG_p Gain flatness	$f = 0.5$ to 3 GHz	± 0.5	dB
Gain temperature coefficient	$T_{BP} = -55^\circ\text{C}$ to 90°C	-0.01	dB/°C
P_{1dB} Output power at 1-dB gain compression	$f = 0.5$ to 3 GHz	12	dBm
NF Noise figure	$f = 0.5$ to 3 GHz	3.5	dB
IP_3 Output third-order intercept point	0.5 GHz	21	dBm
	1.5 GHz	21	
	3 GHz	20.5	

$V^+ = 12\text{ V}, V_{CTRL} = 0\text{ V}, T_A = 25^\circ\text{C}$

DC CHARACTERISTICS

PARAMETER	TEST CONDITIONS	TYP	UNIT
I^+ I_{DSS}	$V_{DS} = .5\text{ V}$ to $3.5\text{ V}, V_{GS} = 0\text{ V}$	81.2	mA

$V^+ = 12\text{ V}, V_{CTRL} = 0\text{ V}, T_A = 25^\circ\text{C}$

V_{ds} for I_{dss} is the drain voltage between .5V and 3.5 V at which drain current is highest.

EQUIVALENT SCHEMATIC

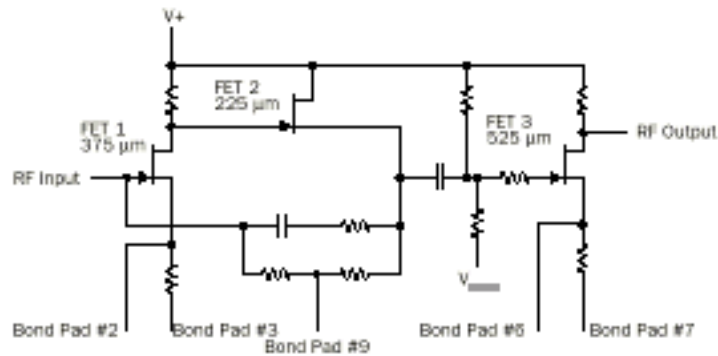

TYPICAL BIAS NETWORK

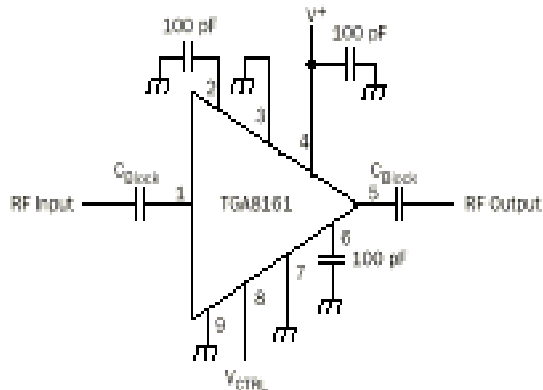

RECOMMENDED TEST CONFIGURATION



RECOMMENDED ASSEMBLY DIAGRAM

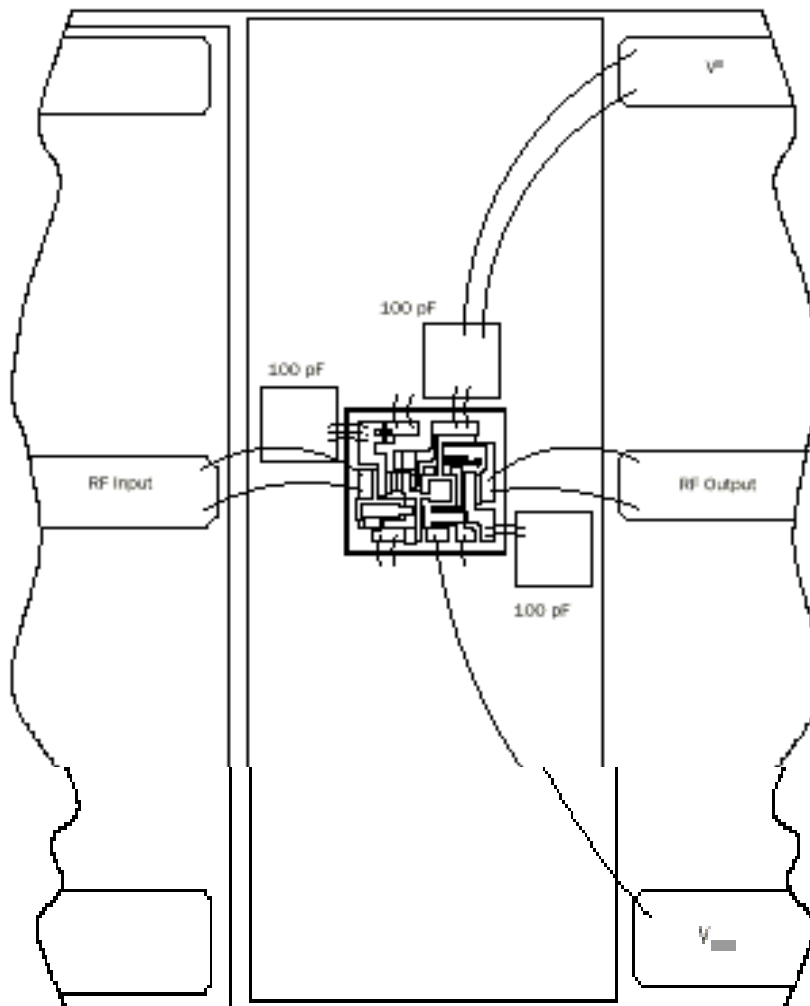

DC blocks are not provided at RF ports.

Close placement of external components is essential for stability and RF performance.

RF connections: Bond using two 1-mil diameter, 40-mil-length or less gold bond wires at both RF Input and RF Output.

MECHANICAL DRAWING

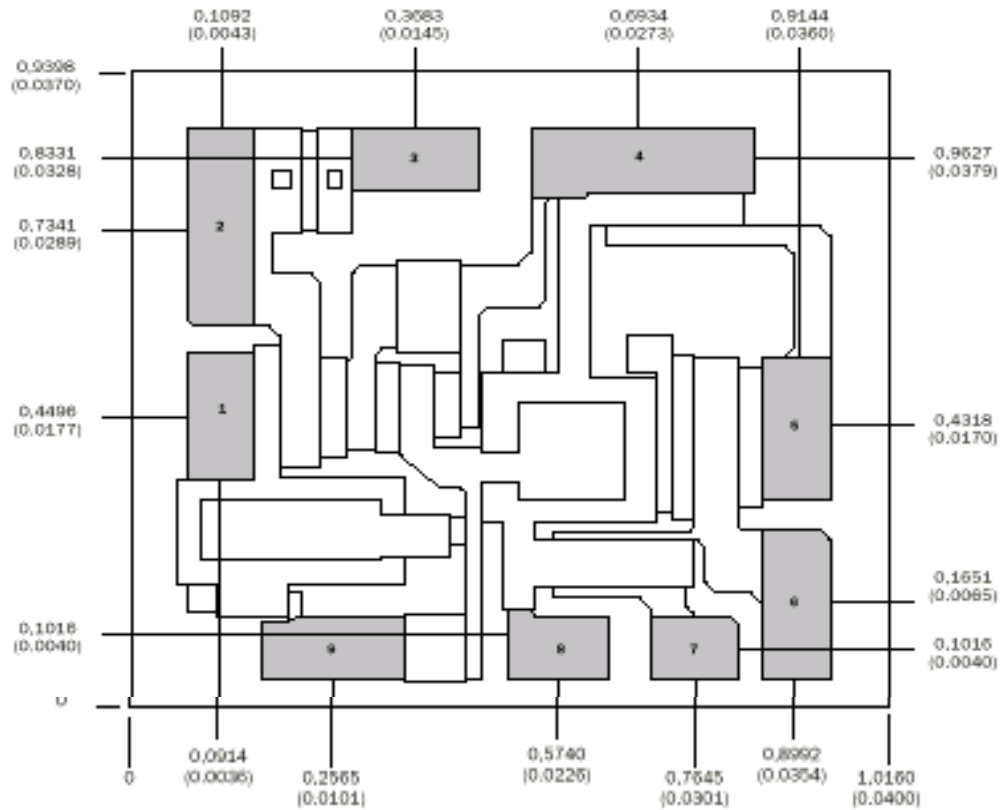

Units: Millimeters (inches)

Thickness: 0,1524 (0,006) (reference only)

Chip-edge-to-bond pad dimensions are shown to center of bond pad.

Chip size $\pm 0,0508$ (0,002)

Bond pad #1 (RF Input):	0,0864 x 0,1956 (0,0034 x 0,0077)
Bond pad #2 :	0,1270 x 0,3023 (0,0050 x 0,0119)
Bond pad #3 :	0,1981 x 0,0991 (0,0078 x 0,0039)
Bond pad #4 (V ⁺):	0,3226 x 0,1016 (0,0127 x 0,0040)
Bond pad #5 (RF Output):	0,1016 x 0,2210 (0,0040 x 0,0087)
Bond pad #6 :	0,1016 x 0,2311 (0,0040 x 0,0091)
Bond pad #7 :	0,1295 x 0,1016 (0,0051 x 0,0040)
Bond pad #8 (V _{cm}):	0,1473 x 0,1016 (0,0058 x 0,0040)
Bond pad #9 :	0,2057 x 0,1016 (0,0081 x 0,0040)

GaAs MMIC devices are susceptible to damage from Electrostatic Discharge. Proper precautions should be observed during handling, assembly and test.