



TGA9083-EEU

Power Amplifier

9083

- **6.5 to 11.5-GHz Frequency Range**
- **5-Watt Output Power at 7V , 6-W at 8V, 8-W at 9 Volt Drain Bias**
- **19-dB Typical Small Signal Gain**
- **40% Power Added Efficiency at 7V, 35% PAE at 9 Volt Drain Bias**
- **12-dB Typical Input Return Loss, 9-dB Typical Output Return Loss**
- **On-Chip Active Gate Bias Circuit Option Simplifies Biasing**
- **4, 521 x 3,048 x 0,100 mm (0.178 x 0.120 x 0.004 in.)**

PHOTO ENLARGEMENT

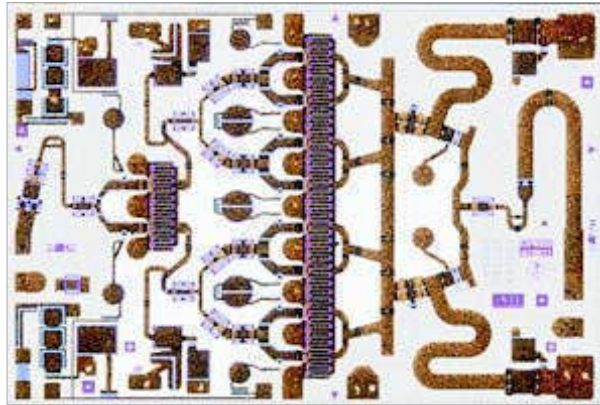

DESCRIPTION

The TriQuint TGA9083 -EEU is a monolithic power amplifier which operates from 6.5 to 11.5 GHz. This device is currently classified as an Engineering Evaluation Unit. This two stage power amplifier partially consists of a 2.5-mm pHEMT driving a 11.36-mm pHEMT at the output. The TGA9083-EEU is capable of providing 8 Watts of output power with 35% PAE when biased at 9 Volts. Typical 7 Volts operation provides 5 Watts of output power with a power-added efficiency of 40 percent. Typical small signal gain is 19-dB. In balanced configuration, 12 Watts of output power is achievable with 40% PAE.

The TGA9083-EEU is fabricated using TI's 0.25um T-gate power pHEMT process. This device offers either standard gate biasing or an on-chip active gate bias circuit which simplifies gate biasing. The active gate bias (AGB) circuit requires a -5 V supply. This amplifier's output power and high efficiency over 6.5 to 11.5 GHz make it a viable power amp solution in applications such as point-to-point radio, phased-array radar, and telecommunications.

Bond pad and backside metallization is gold plated for compatibility with eutectic alloy attachment methods as well as with thermocompression and thermosonic wire-bonding processes.

The TGA9083-EEU is supplied in chip form and is readily assembled using automated equipment. Ground is provided to the circuitry through vias to the backside metallization.

**TYPICAL
OUTPUT POWER**

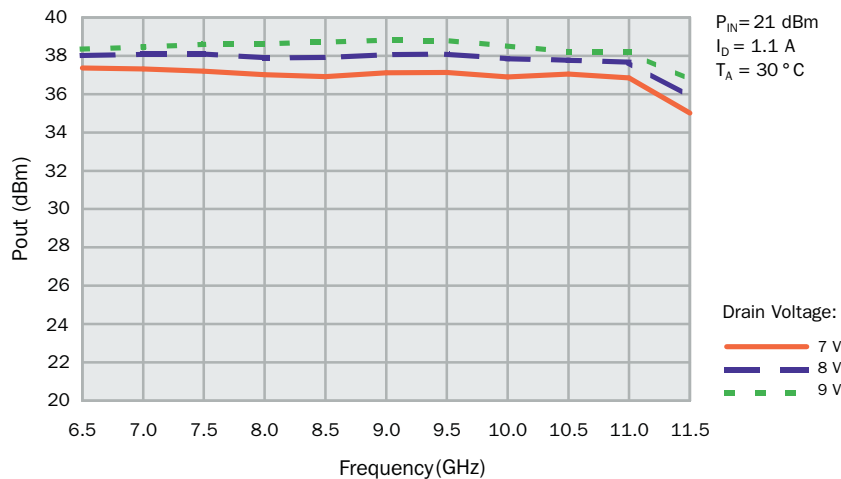

**TYPICAL
POWER-ADDED
EFFICIENCY**

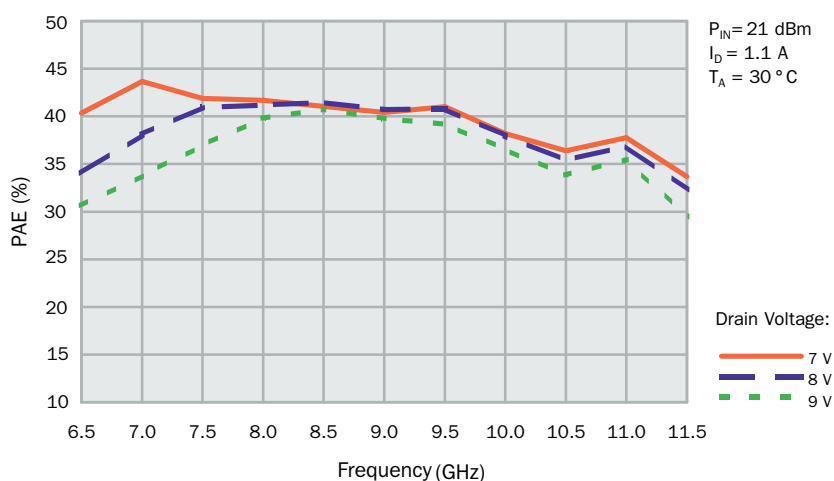

**TYPICAL
SMALL SIGNAL GAIN**

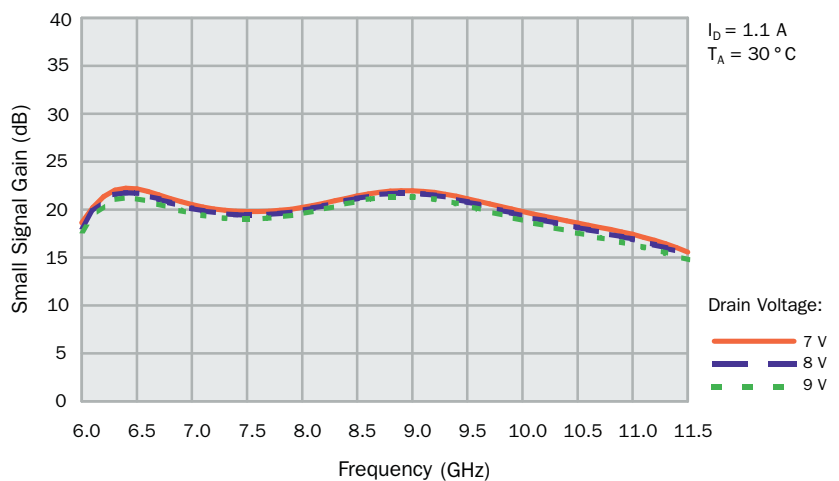

**TYPICAL
INPUT RETURN LOSS**

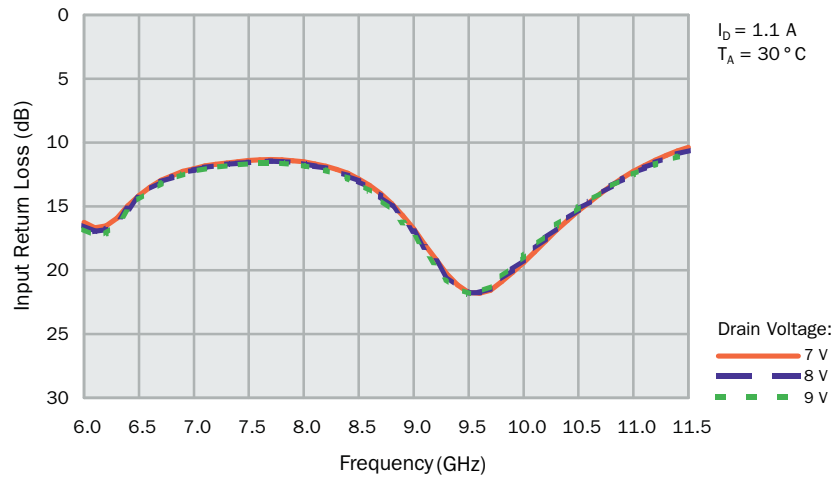

**TYPICAL
OUTPUT RETURN LOSS**

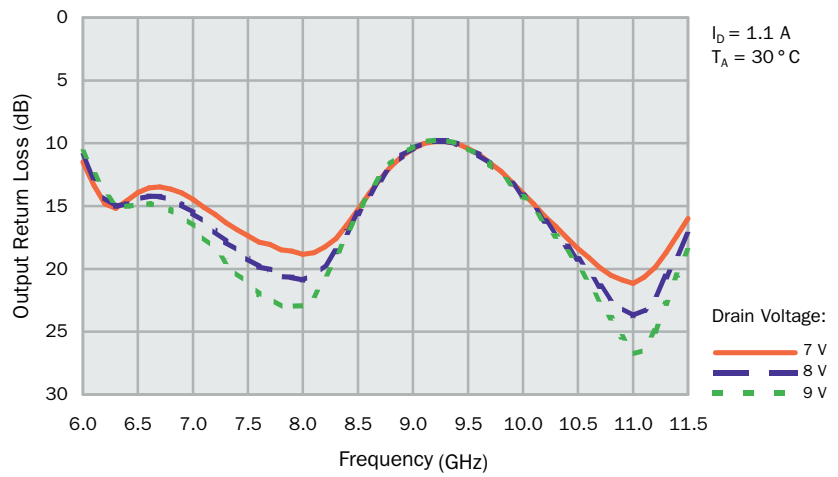

**TYPICAL
DRAIN CURRENT**

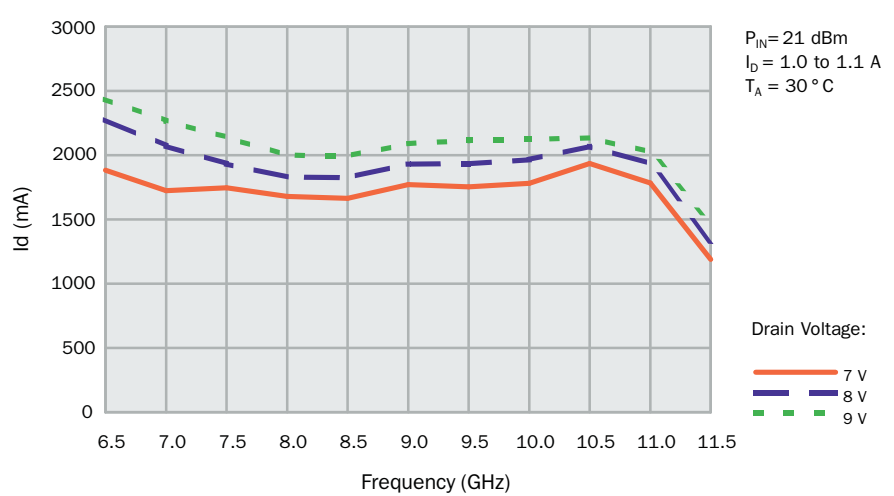

**ABSOLUTE
MAXIMUM RATINGS**

Drain supply voltage, V_D	10 V
Negative supply voltage range, V_G	-5 V to 0 V
Drain supply current, I_D	3.5 A
Power dissipation, P_D , at (or below) 25 C base-plate temperature*	39 W
Input continuous wave power, P_{IN}	25.5 dBm
Operating channel temperature, T_{CH} **	150 C
Mounting temperature (30 sec), T_M	320 C
Storage temperature range, T_{STG}	-65 to 150 C

Ratings over operating channel temperature range, T_{CH} (unless otherwise noted)

Stresses beyond those listed under “Absolute Maximum Ratings” may cause permanent damage to the device. These are stress ratings only, and functional operation of the device at these or any other conditions beyond those indicated under “RF Characteristics” is not implied. Exposure to absolute maximum rated conditions for extended periods may affect device reliability.

* For operation above 25 C base-plate temperature, derate linearly at the rate of 73 mW/ C.

** Operating channel temperature directly affects the device MTTF. For maximum life, it is recommended that channel temperature be maintained at the lowest possible level.

TYPICAL S-PARAMETERS

Frequency (GHz)	S11		S21		S12		S22	
	dB	ANG(°)	dB	ANG(°)	dB	ANG(°)	dB	ANG(°)
6.5	-14.31	-78.1	21.77	168.2	-64.33	88.1	-14.44	114.4
6.6	-13.64	-94.1	21.69	146.0	-60.56	81.2	-14.21	89.3
6.7	-13.08	-107.7	21.42	125.7	-58.66	70.2	-14.24	69.1
6.8	-12.72	-118.8	21.09	107.0	-57.67	59.6	-14.50	50.1
6.9	-12.36	-128.4	20.74	89.7	-57.01	48.2	-14.91	34.3
7.0	-12.15	-136.9	20.40	73.4	-56.72	37.4	-15.53	17.3
7.1	-11.94	-144.3	20.12	57.9	-56.97	28.1	-16.28	1.9
7.2	-11.81	-151.0	19.88	43.1	-57.08	20.2	-16.99	-14.2
7.3	-11.71	-157.2	19.69	28.9	-57.77	11.7	-17.83	-30.1
7.4	-11.62	-163.0	19.55	14.9	-57.76	4.5	-18.52	-46.3
7.5	-11.54	-168.6	19.48	1.3	-57.76	-5.0	-19.16	-61.9
7.6	-11.48	-174.6	19.44	-12.1	-57.71	-14.8	-19.83	-75.8
7.7	-11.46	179.6	19.45	-25.4	-58.13	-28.3	-20.05	-88.6
7.8	-11.49	173.5	19.51	-38.6	-58.49	-39.3	-20.59	-98.0
7.9	-11.56	167.5	19.61	-51.8	-58.82	-50.7	-20.68	-105.8
8.0	-11.64	161.1	19.75	-65.0	-58.75	-62.5	-20.89	-108.7
8.1	-11.84	154.7	19.93	-78.4	-59.10	-79.3	-20.52	-109.5
8.2	-12.00	148.0	20.16	-92.1	-59.09	-95.6	-19.67	-108.5
8.3	-12.27	140.8	20.41	-106.1	-59.22	-113.4	-18.60	-107.9
8.4	-12.59	133.2	20.67	-120.4	-58.89	-133.1	-17.09	-109.5
8.5	-13.03	124.8	20.93	-135.0	-58.80	-149.5	-15.59	-112.4
8.6	-13.55	115.8	21.18	-150.0	-58.78	-170.2	-14.14	-117.2
8.7	-14.20	106.2	21.39	-165.3	-58.42	173.1	-12.89	-124.4
8.8	-15.00	95.7	21.56	179.2	-58.06	152.0	-11.82	-132.0
8.9	-15.96	84.3	21.67	163.6	-57.95	133.7	-10.98	-141.0
9.0	-16.95	72.4	21.72	147.9	-57.57	114.0	-10.41	-150.3
9.1	-18.19	59.3	21.71	132.2	-57.49	93.9	-9.98	-160.1
9.2	-19.31	45.4	21.63	116.7	-57.13	77.9	-9.83	-170.4
9.3	-20.44	29.9	21.49	101.3	-57.62	59.4	-9.84	179.4
9.4	-21.28	14.1	21.30	86.3	-57.57	40.5	-10.03	168.5
9.5	-21.77	-3.6	21.07	71.4	-57.59	20.7	-10.44	158.1
9.6	-21.75	-19.6	20.81	56.8	-57.61	3.4	-10.91	147.1
9.7	-21.45	-35.6	20.52	42.5	-57.36	-15.4	-11.62	136.0
9.8	-20.72	-48.2	20.24	28.3	-57.08	-32.3	-12.32	124.6
9.9	-19.95	-58.9	19.95	14.3	-56.69	-51.1	-13.23	112.1
10.0	-19.15	-68.3	19.67	0.4	-56.18	-64.5	-14.16	100.1
10.1	-18.33	-76.7	19.38	-13.4	-55.71	-80.0	-15.11	86.9
10.2	-17.51	-84.1	19.11	-27.2	-54.67	-92.3	-16.20	73.2
10.3	-16.67	-91.4	18.86	-41.1	-54.34	-106.2	-17.11	59.2
10.4	-15.95	-98.1	18.61	-55.0	-53.49	-119.4	-18.22	43.6
10.5	-15.23	-104.5	18.37	-69.0	-53.00	-133.6	-19.22	28.4
10.6	-14.62	-110.8	18.13	-83.0	-52.35	-144.6	-20.24	11.4
10.7	-13.99	-117.4	17.89	-97.2	-51.80	-155.4	-21.37	-7.1
10.8	-13.41	-123.9	17.65	-111.8	-51.56	-166.5	-22.33	-26.6
10.9	-12.87	-130.8	17.42	-126.3	-51.12	-178.6	-23.12	-50.8
11.0	-12.39	-137.8	17.17	-141.0	-50.77	170.8	-23.74	-75.6
11.1	-11.97	-145.6	16.93	-156.2	-50.69	159.1	-23.25	-104.2
11.2	-11.57	-153.5	16.64	-171.4	-50.33	147.9	-22.17	-131.1
11.3	-11.21	-162.1	16.34	173.1	-50.57	136.5	-20.63	-153.4
11.4	-10.91	-171.2	16.00	157.3	-50.76	124.9	-18.89	-174.0
11.5	-10.63	179.2	15.63	141.4	-50.93	112.2	-17.29	168.8

 $T_A = 25^\circ\text{C}$, $V_D = +8\text{V}$, $I_D = 1.1\text{A}$

Reference planes for S-parameter data include bond wires as specified in the "Recommended Assembly Diagram."

RF CHARACTERISTICS

PARAMETER	TEST CONDITIONS	TYP	UNIT
GP Small Signal Power Gain	6.5 to 11.5 GHz	9	dB
IRL Input Return Loss	6.5 to 11.5 GHz	12	dB
ORL Output Return Loss	6.5 to 11.5 GHz	9	dB
PAE Power Added Efficiency	6.5 to 11.5 GHz	40	%
P_{2dB} Output Power at 2-dB Gain Compression	6.5 to 11.5 GHz	37	dBm
IP_3 Output Third-order Intercept Point	6.5 to 11.5 GHz	44	dBm

$V_D = +7\text{ V}$, $I_D = 1.5\text{ A}$, $T_A = 25\text{ }^\circ\text{C}$ unless stated

THERMAL INFORMATION

PARAMETER	TEST CONDITIONS	NOM	UNIT
R_{jc} Thermal resistance, channel to backside	25°C Base, $V_D = 9\text{ V}$, $I_D = 1.2\text{ A}$, $P_D = 6\text{ W}$	10	°C/W

EQUIVALENT SCHEMATIC

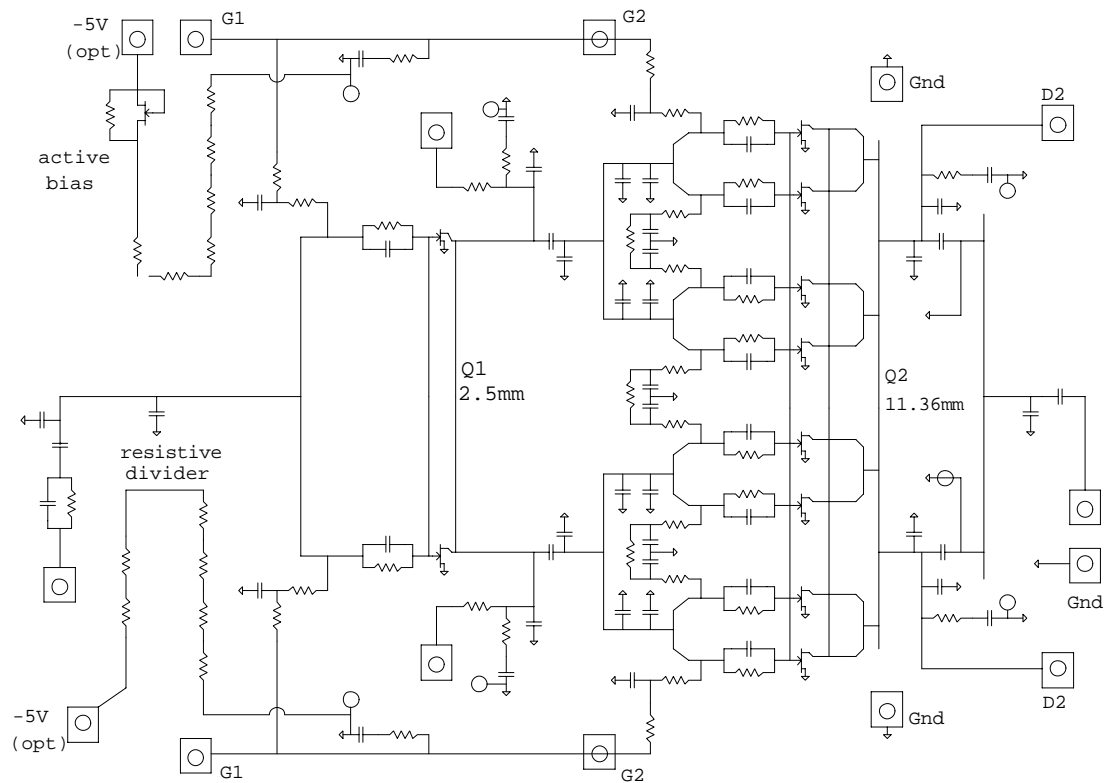

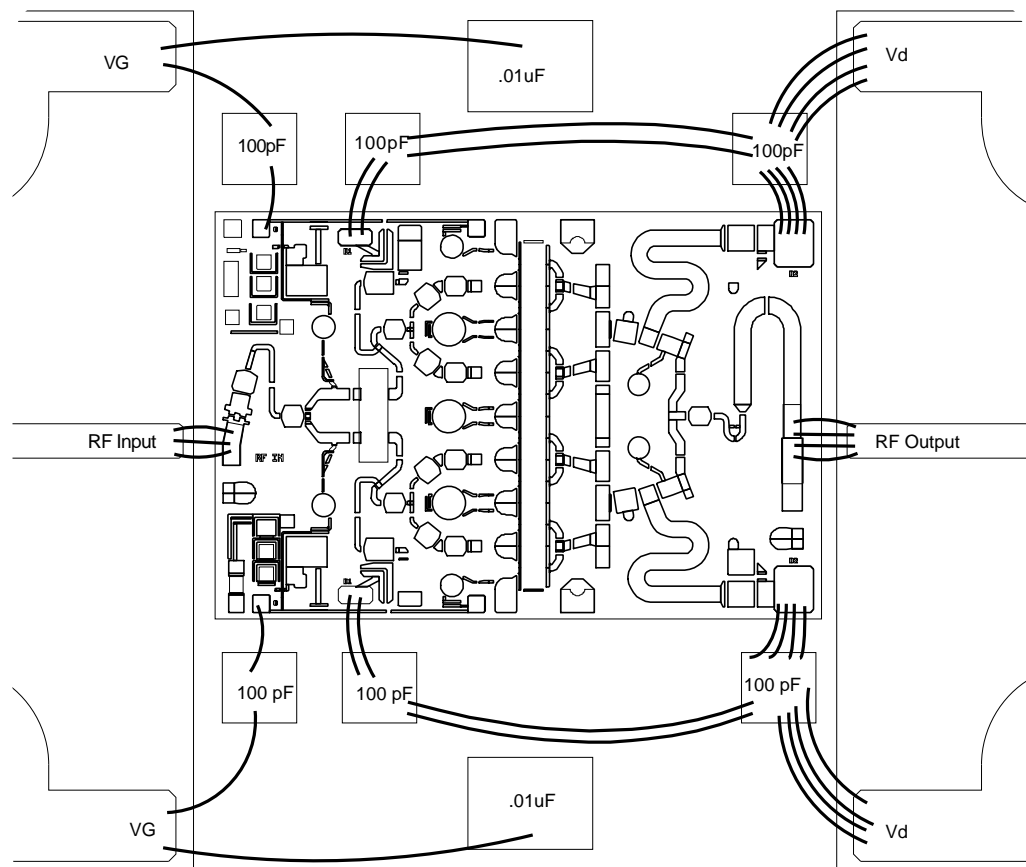
**RECOMMENDED
ASSEMBLY DIAGRAM**

Bond using three (four at RF_{OUT}) 1.0-mil diameter, 25 to 30-mil length gold bondwires at RF Input and RF Output for optimum performance. Bond wires connected to the RF Output pad should be equal distance from center line as indicated in drawing. Close placement of external components is essential to stability.

Gate bias (V_G) voltage can be applied from either side of MMIC.

Drain bias (V_D) voltage should be connected to both sides of MMIC.

**RECOMMENDED
ASSEMBLY DIAGRAM
USING ACTIVE GATE
BIAS CIRCUIT**

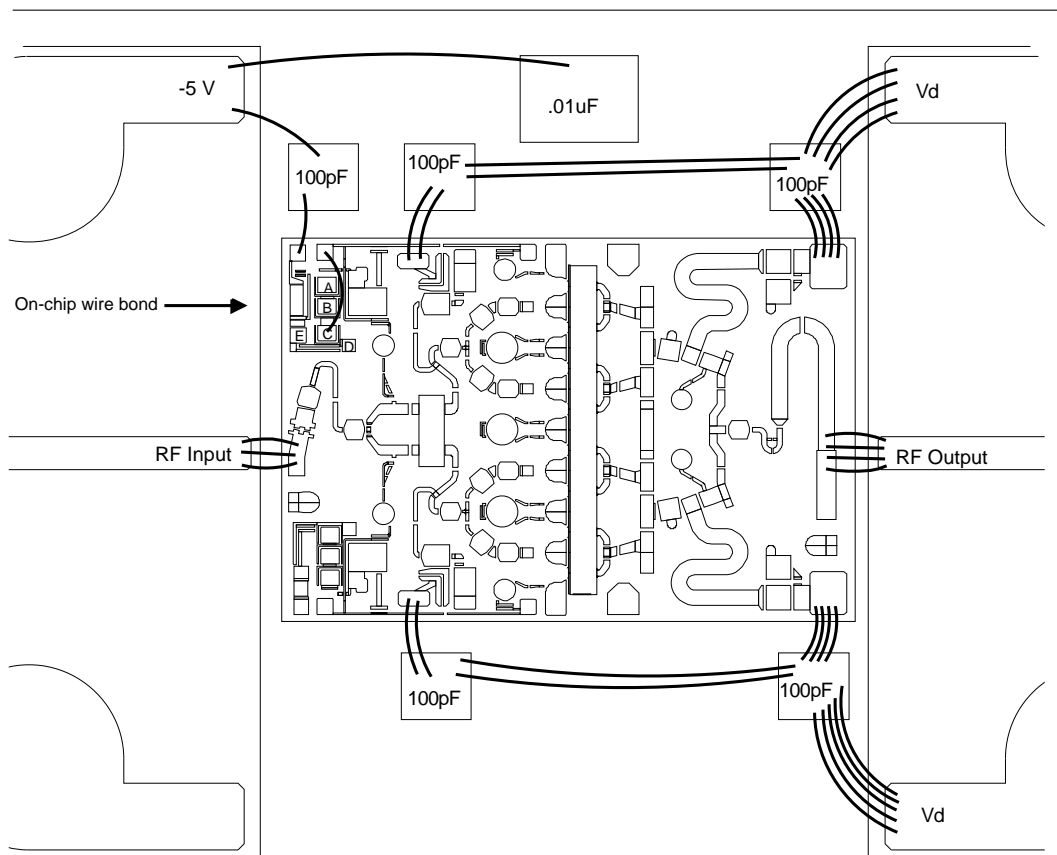

Bond using three (four at RF_{OUT}) 1.0-mil diameter, 25 to 30-mil length gold bondwires at RF Input and RF Output for optimum performance. Bond wires connected to the RF Output pad should be equal distance from center line as indicated in drawing. Close placement of external components is essential to stability. Drain bias (V_d) voltage should be connected to both sides of MMIC.

MECHANICAL DRAWING

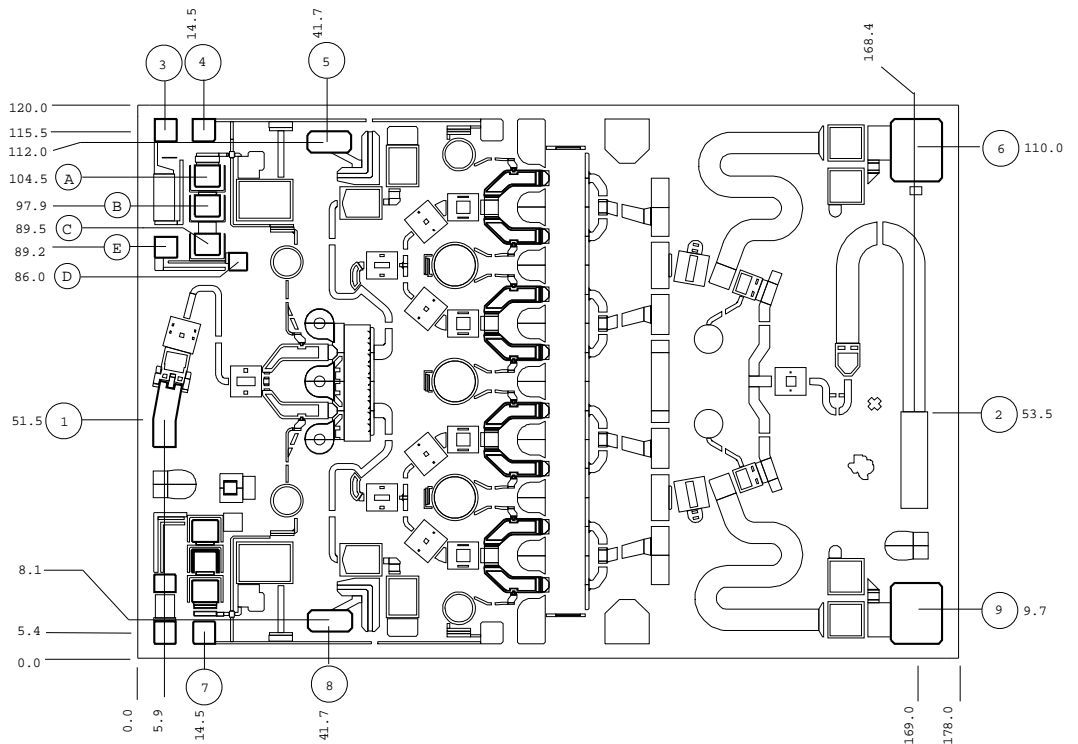

Units: millimeters (inches)
 Thickness: 0,1016 (0.004) (reference only)
 Chip edge to bond pad dimensions are shown to center of bond pad.
 Chip size +/- 0,0508 (0.002)

Bond pad #1	(RF Input)	Center two bond wires equal distance from center line
Bond pad #2	(RF Output)	Center two bond wires equal distance from center line
Bond pad #3	(-V _{AGB})	0,120 x 0,120 (.0047 x .0047)
Bond pad #4, #7	(-V _G)	0,120 x 0,120 (.0047 x .0047)
Bond pad #5, #8	(V _{D1})	0,240 x 0,120 (.0094 x .0047)
Bond pad #6, #9	(V _{D2})	0,275 x 0,340 (.0108 x .0134)
Bond pads A,B,C,D,E		0,120 x 0,120 (.0047 x .0047)