

### APPLICATIONS

- Rectification
- Freewheel Diode
- DC Motor Control
- Power Supplies
- Welding
- Battery Chargers

### KEY PARAMETERS

$V_{RRM}$	<b>3000V</b>
$I_{F(AV)}$	<b>1315A</b>
$I_{FSM}$	<b>20000A</b>

### FEATURES

- Double Side Cooling
- High Surge Capability

### VOLTAGE RATINGS

Type Number	Repetitive Peak Reverse Voltage $V_{RRM}$ V	Conditions
TR1104SG30	3000	$V_{RSM} = V_{RRM} + 100V$
TR1104SG29	2900	
TR1104SG28	2800	
TR1104SG27	2700	
TR1104SG26	2600	
TR1104SG25	2500	

Lower voltage grades available.

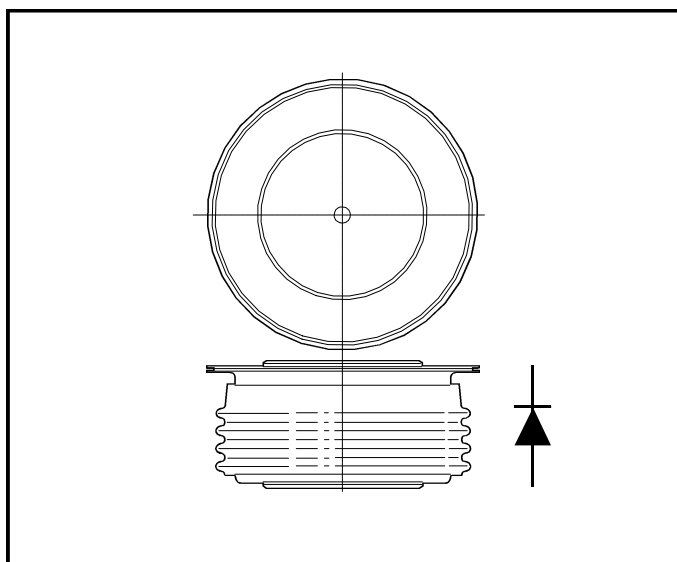

Outline type code: G.  
See Package Details for further information.

### CURRENT RATINGS

Symbol	Parameter	Conditions	Max.	Units
<b>Double Side Cooled</b>				
$I_{F(AV)}$	Mean forward current	Half wave resistive load, $T_{case} = 100^{\circ}C$	1315	A
$I_{F(RMS)}$	RMS value	$T_{case} = 100^{\circ}C$	2065	A
$I_F$	Continuous (direct) forward current	$T_{case} = 100^{\circ}C$	1880	A
<b>Single Side Cooled (Anode side)</b>				
$I_{F(AV)}$	Mean forward current	Half wave resistive load, $T_{case} = 100^{\circ}C$	840	A
$I_{F(RMS)}$	RMS value	$T_{case} = 100^{\circ}C$	1320	A
$I_F$	Continuous (direct) forward current	$T_{case} = 100^{\circ}C$	1130	A

## SURGE RATINGS

Symbol	Parameter	Conditions	Max.	Units
$I_{FSM}$	Surge (non-repetitive) forward current	10ms half sine; $T_{case} = 175^{\circ}C$	16.0	kA
$I^2t$	$I^2t$ for fusing	$V_R = 50\% V_{RRM}$ - 1/4 sine	$1.28 \times 10^6$	$A^2s$
$I_{FSM}$	Surge (non-repetitive) forward current	10ms half sine; $T_{case} = 175^{\circ}C$	20.0	kA
$I^2t$	$I^2t$ for fusing	$V_R = 0$	$2.0 \times 10^6$	$A^2s$

## THERMAL AND MECHANICAL DATA

Symbol	Parameter	Conditions	Min.	Max.	Units	
$R_{th(j-c)}$	Thermal resistance - junction to case	Double side cooled	dc	-	0.032	$^{\circ}C/W$
		Single side cooled	Anode dc	-	0.064	$^{\circ}C/W$
			Cathode dc	-	0.064	$^{\circ}C/W$
$R_{th(c-h)}$	Thermal resistance - case to heatsink	Clamping force 12.0kN with mounting compound	Double side	-	0.008	$^{\circ}C/W$
			Single side	-	0.016	$^{\circ}C/W$
$T_{vj}$	Virtual junction temperature	Forward (conducting)		-	185	$^{\circ}C$
		Reverse (blocking)		-	175	$^{\circ}C$
$T_{stg}$	Storage temperature range		-55	200	$^{\circ}C$	
-	Clamping force		11.5	13.5	kN	

## CHARACTERISTICS

Symbol	Parameter	Conditions	Min.	Max.	Units
$V_{FM}$	Forward voltage	At 1800A peak, $T_{case} = 25^{\circ}C$	-	1.3	V
$I_{RRM}$	Peak reverse current	At $V_{RRM}$ , $T_{case} = 175^{\circ}C$	-	50	mA
$Q_S$	Total stored charge	$I_F = 1000A$ , $di_{RR}/dt = 3A/\mu s$ $T_{case} = 175^{\circ}C$ , $V_R = 100V$	-	1600	$\mu C$
$I_{RR}$	Peak recovery current		-	85	A
$V_{TO}$	Threshold voltage	At $T_{vj} = 175^{\circ}C$	-	0.67	V
$r_T$	Slope resistance	At $T_{vj} = 175^{\circ}C$	-	0.31	m $\Omega$

CURVES

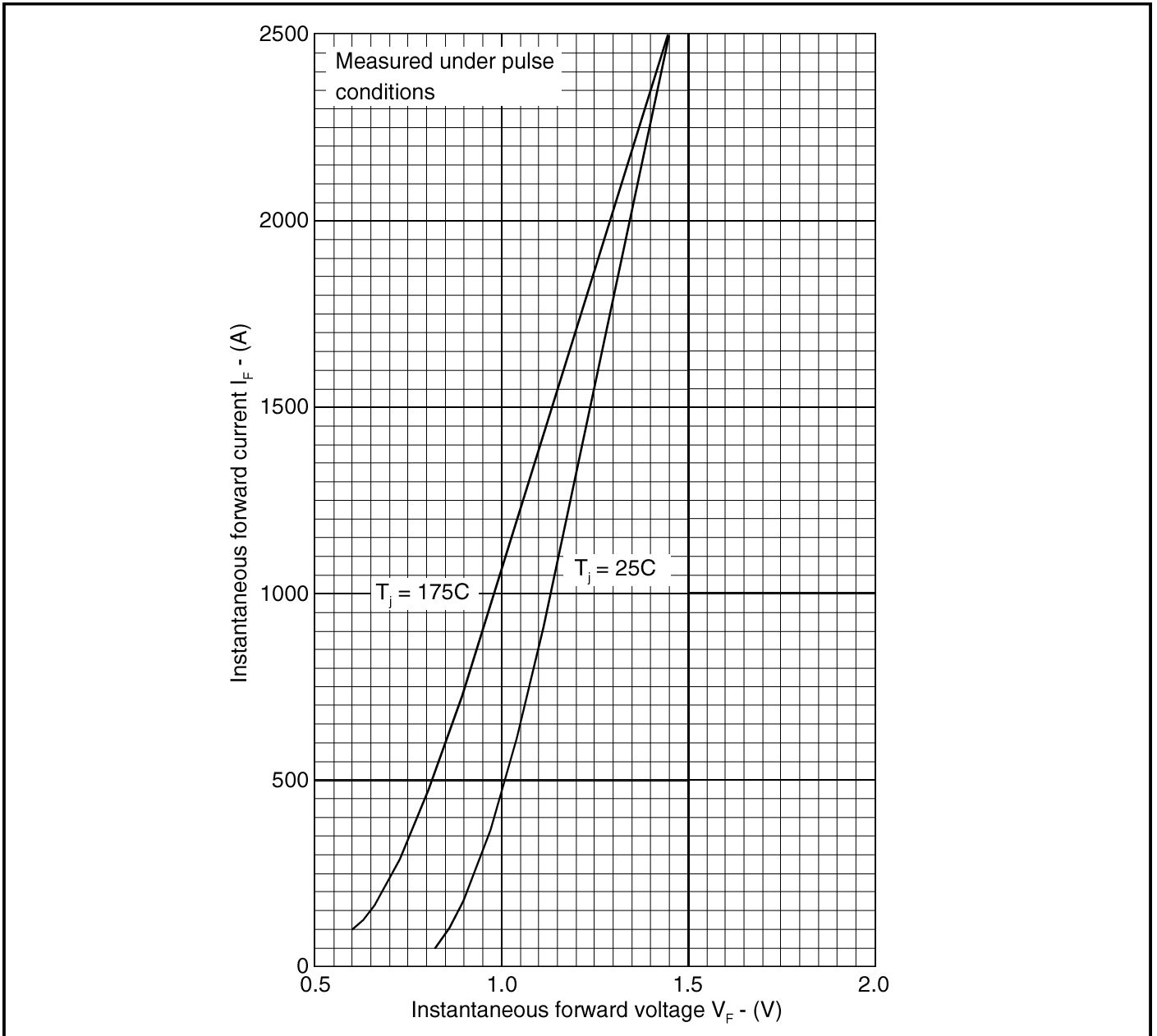

Fig. 1 Maximum (limit) forward characteristics

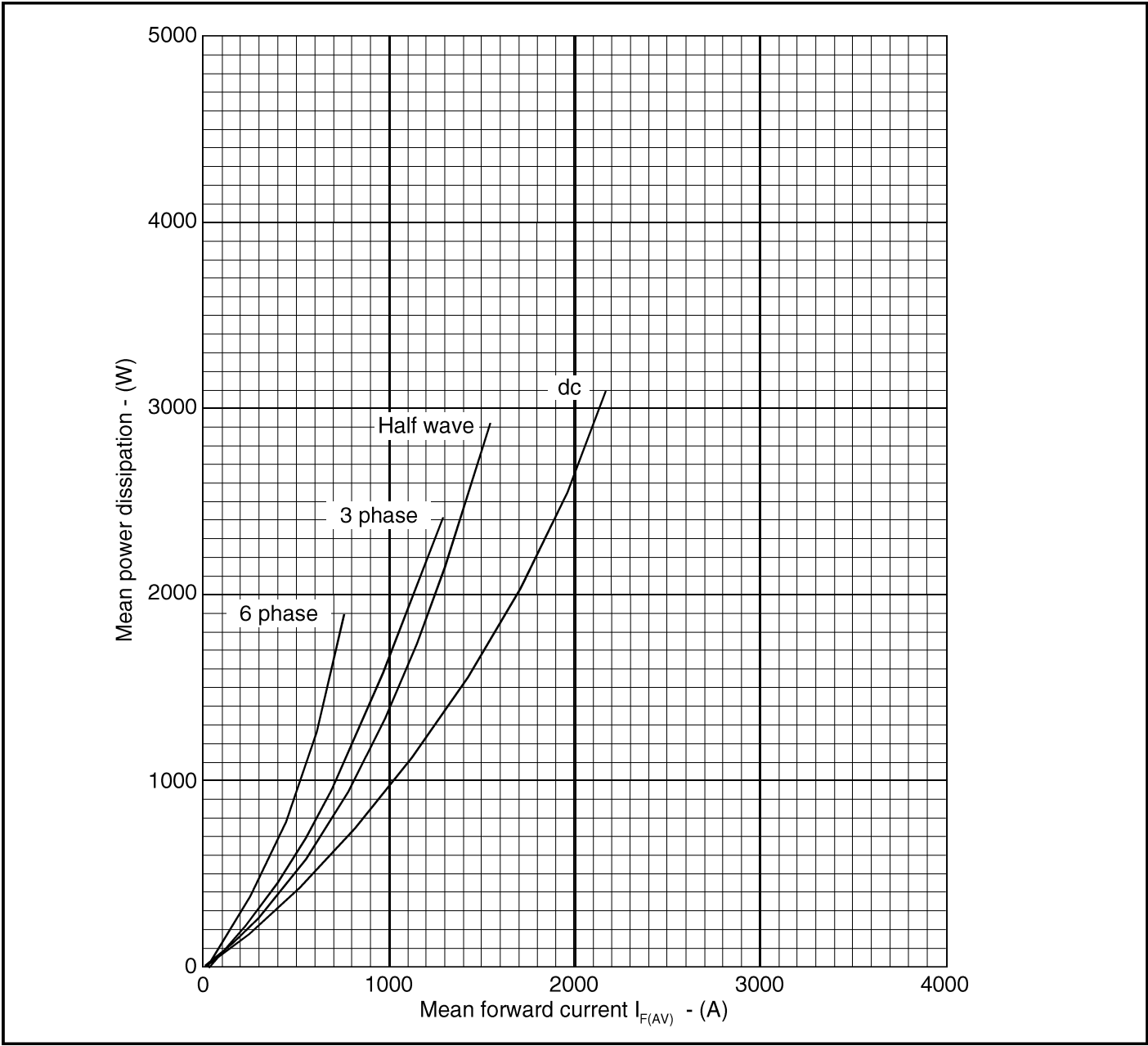

Fig. 2 Dissipation curves

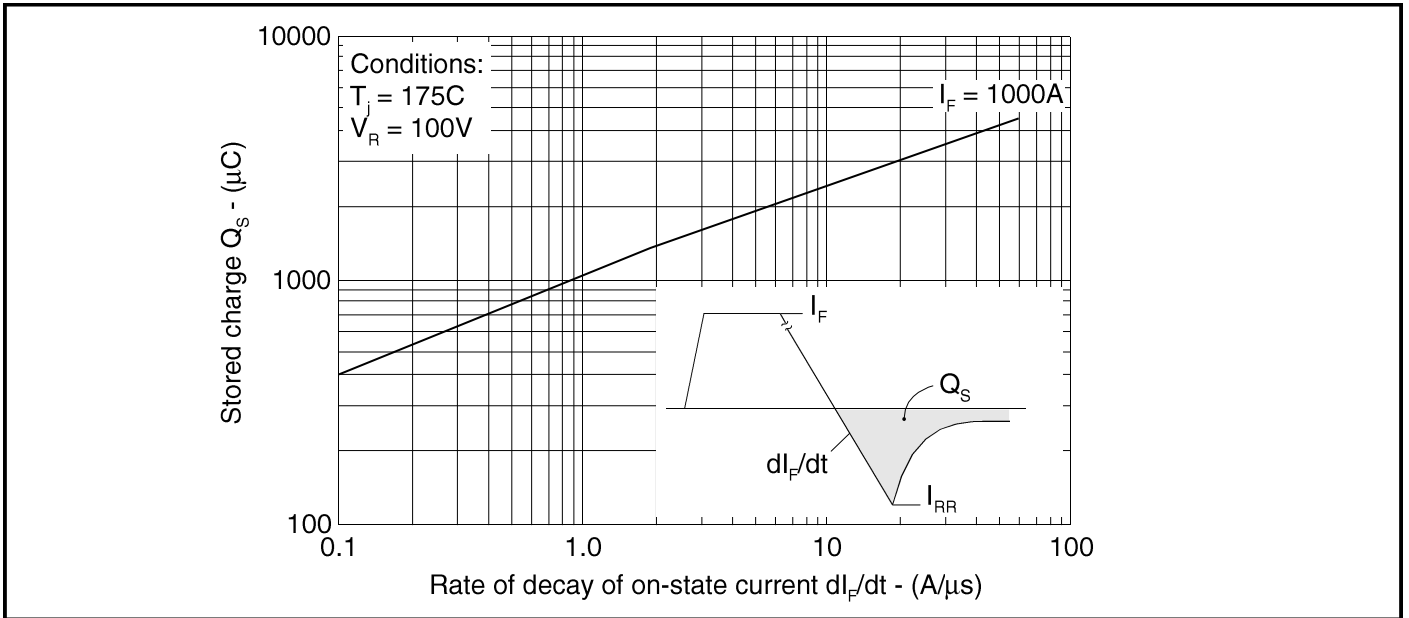

Fig. 3 Maximum total stored charge

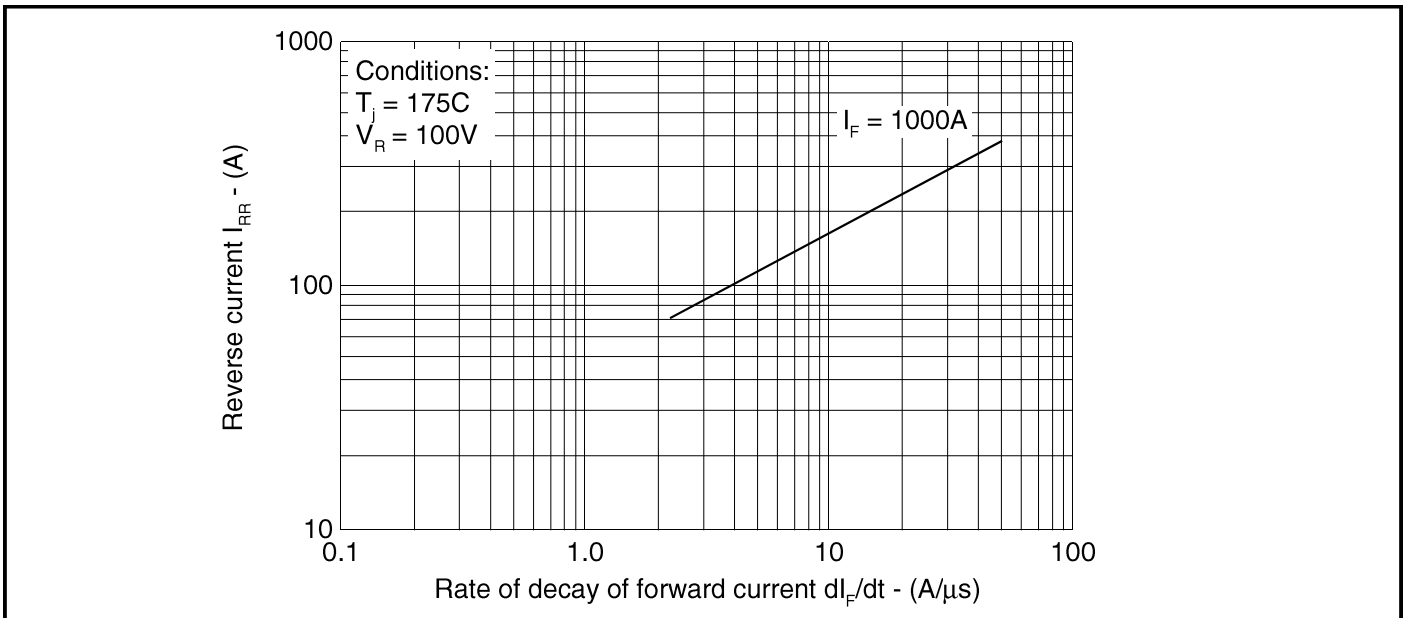

Fig. 4 Maximum reverse recovery current

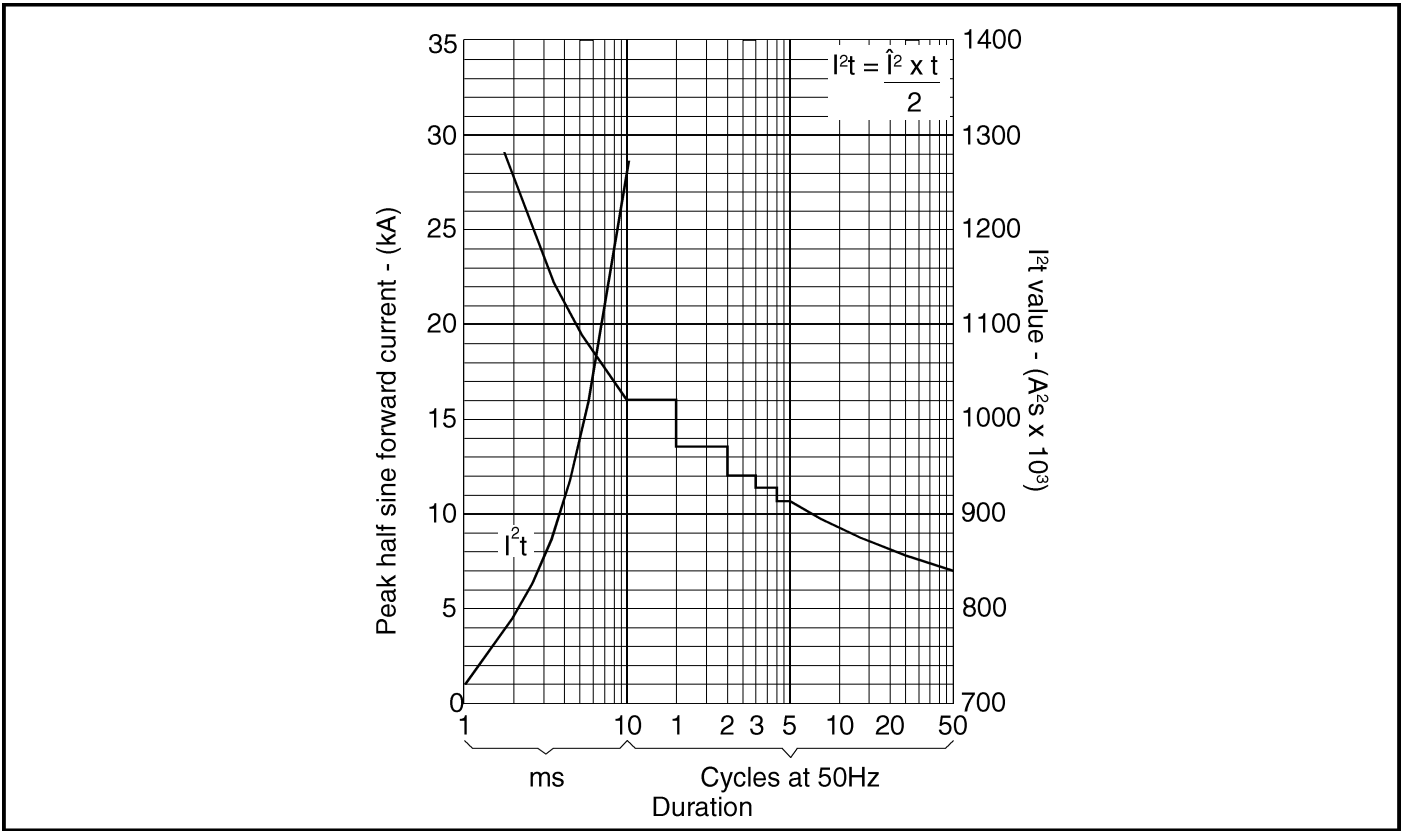

Fig. 5 Surge (non-repetitive) forward current vs time (with 50%  $V_{RRM}$ ,  $T_{case} = 175C$ )

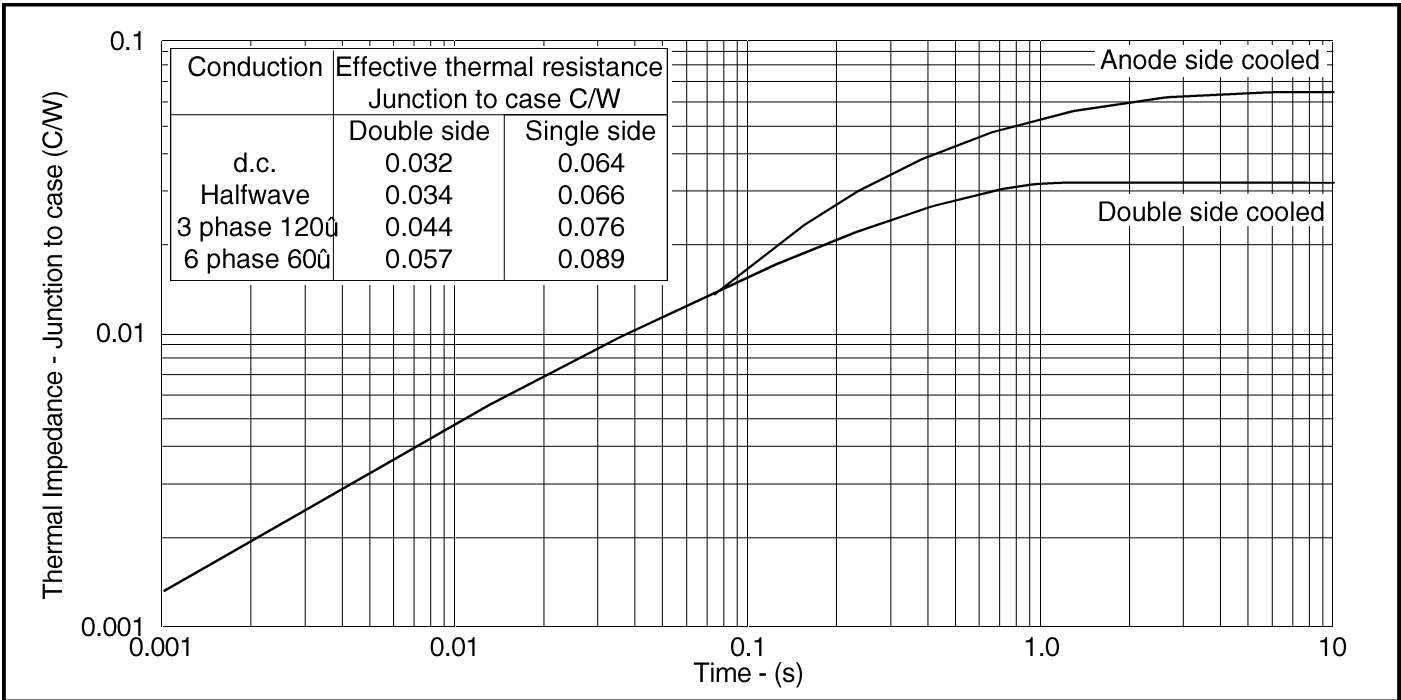

Fig. 6 Transient thermal impedance - junction to case - (C/W)

**PACKAGE DETAILS**

For further package information, please contact your local Customer Service Centre. All dimensions in mm, unless stated otherwise. DO NOT SCALE.

