

36- 40GHz Integrated Down Converter

GaAs Monolithic Microwave IC

preliminary

Description

The CHR2296 is a multifunction chip which integrates a LO time two multiplier, a balanced cold FET mixer, and a RF LNA. It is designed for a wide range of applications, typically commercial communication systems. The backside of the chip is both RF and DC grounds. This helps simplify the assembly process.

The circuit is manufactured with a PM-HEMT process, 0.25 μ m gate length, via holes through the substrate, air bridges and electron beam gate lithography. It is available in chip form.

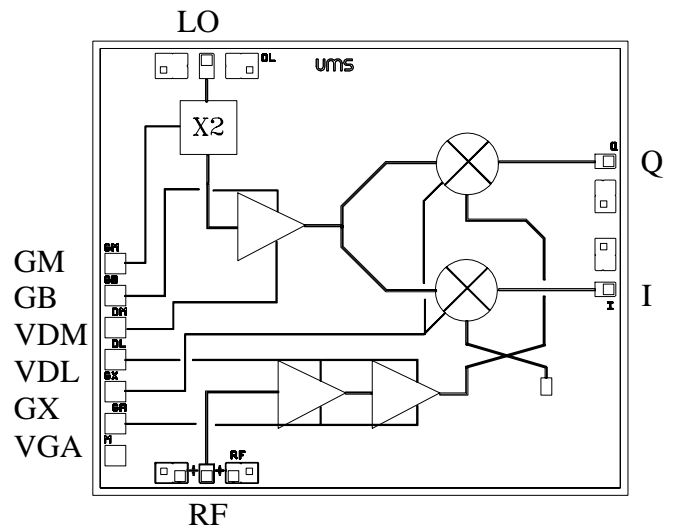

Main Features

- Broadband performances : 36-40GHz
- 11 dB conversion gain
- 5dB noise figure
- 10dBm LO input power
- -10dBm RF input power (1dB gain comp.)
- Low DC power consumption, 110mA@3.5V
- Chip size : 2.49 X 1.97 X 0.10 mm

Typical on wafer measurement:

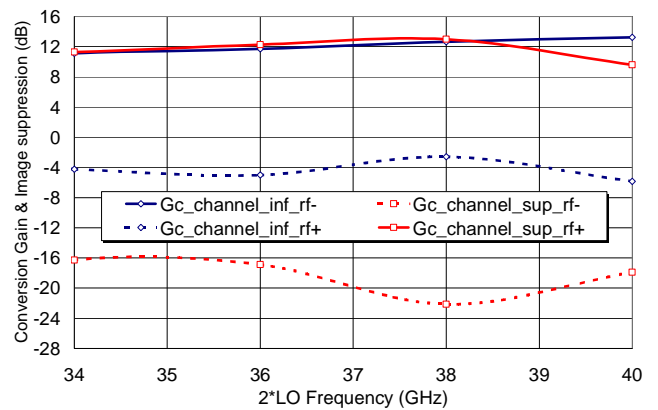

Conversion Gain & Image suppression @ IF=1GHz

Main Characteristics

Tamb. = 25°C

	Parameter	Min	Typ	Max	Unit
F _{RF}	RF frequency range	36		40	GHz
F _{LO}	LO frequency range	17		20	GHz
F _{IF}	IF frequency range	0.25		1.5	GHz
G _c	Conversion gain		11		dB

ESD Protection : Electrostatic discharge sensitive device. Observe handling precautions !

Ref. : DSCHR22962147 25-May-02

1/5

Specifications subject to change without notice

Electrical Characteristics for Broadband Operation

T_{amb} = +25°C, V_d = 3.5V*preliminary*

Symbol	Parameter	Min	Typ	Max	Unit
F _{RF}	RF frequency range	36		40	GHz
F _{LO}	LO frequency range	17		20	GHz
F _{IF}	IF frequency range	0.25		1.5	GHz
G _c	Conversion gain (1)		11		dB
NF	Noise Figure (1)		5		dB
P _{LO}	LO Input power		+10		dBm
Img Sup	Image Suppression		15		dBc
P1dB	Input power at 1dB gain compression		-10		dBm
LO VSWR	Input LO VSWR (1)		2.0:1		
RF VSWR	Input RF VSWR (1)		3.0:1		
I _d	Bias current (2)		110		mA

(1) On Wafer measurements

(2) Current source biasing network is recommended. Optimum performances for I_{dm}= 50mA and I_{dl}= 60mA

Absolute Maximum Ratings

T_{amb.} = 25°C (1)

Symbol	Parameter	Values	Unit
V _d	Maximum drain bias voltage	4.0	V
I _d	Maximum drain bias current	200	mA
V _g	Gate bias voltage	-2.0 to +0.4	V
V _{gd}	Minimum negative gate drain voltage (V _g – V _d)	-5	V
P _{in}	Maximum peak input power overdrive (2)	+15	dBm
T _{ch}	Maximum channel temperature	175	°C
T _a	Operating temperature range	-40 to +85	°C
T _{stg}	Storage temperature range	-55 to +125	°C

(1) Operation of this device above anyone of these parameters may cause permanent damage.

(2) Duration < 1s.

preliminary

Typical On-wafer Measurements

Bias Conditions : $V_{dm} = V_{dl} = 3.5\text{ V}$, $V_{gm} = -0.9\text{ V}$, $V_{gb} = -0.4\text{ V}$, $V_{gx} = -0.8\text{ V}$, $V_{ga} = -0.5\text{ V}$

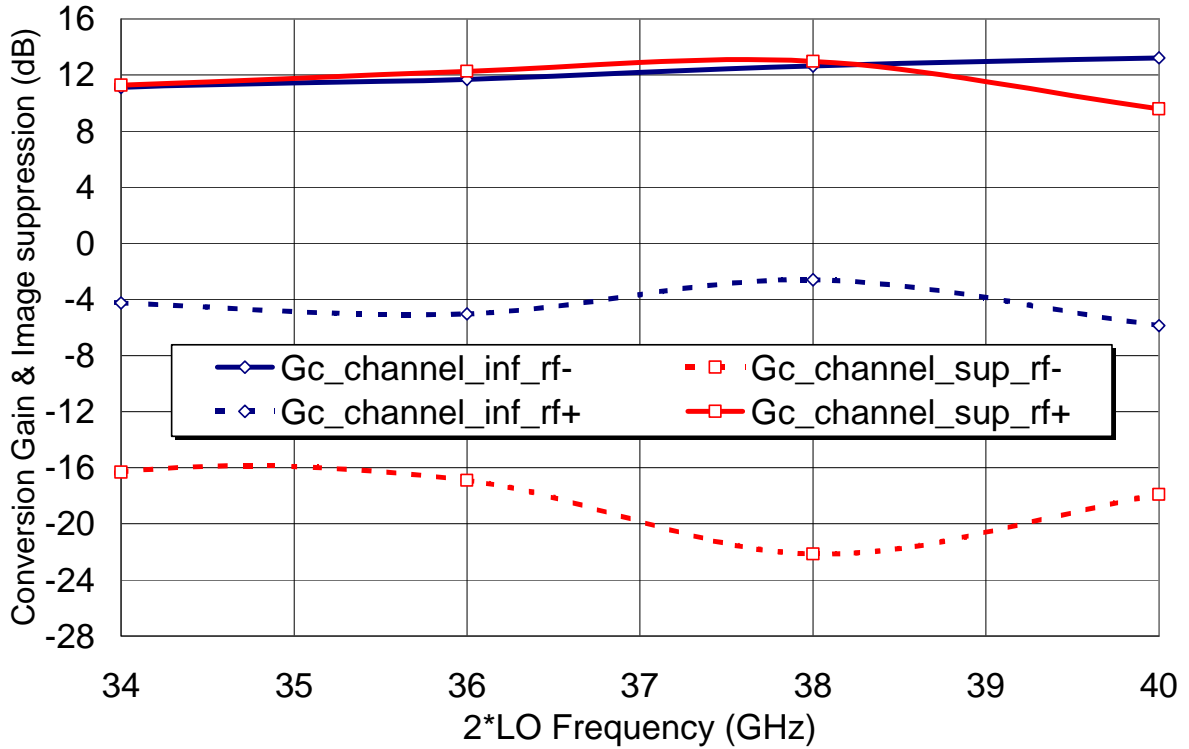

Conversion gain & Image suppression with a 90° IQ combiner @ IF=1GHz

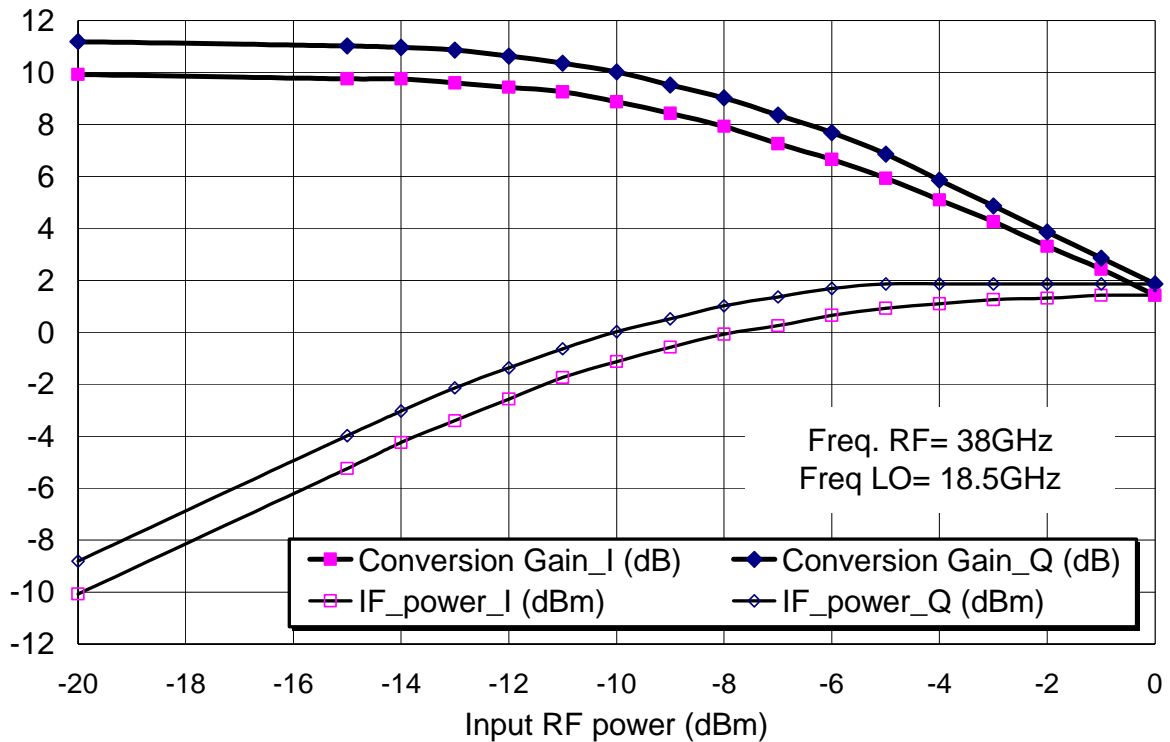

Input RF compression by channel

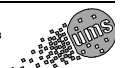

preliminary

Chip Assembly and Mechanical Data

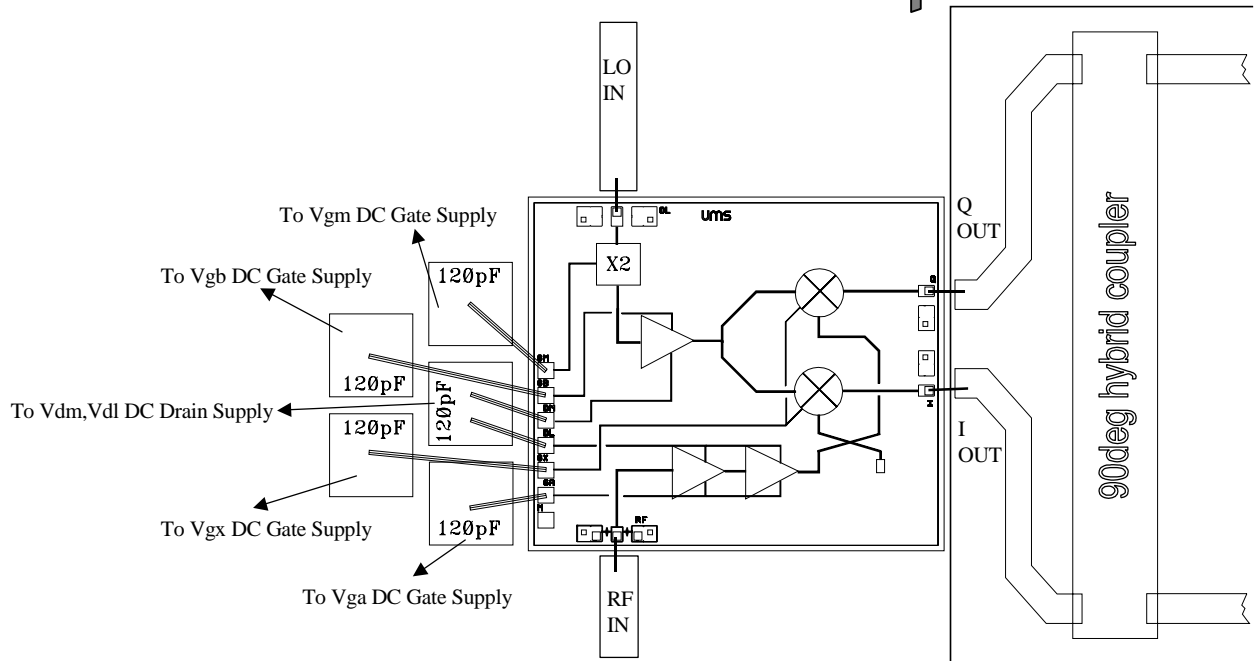

Note : Supply feed should be capacitively bypassed. 25µm diameter gold wire is recommended

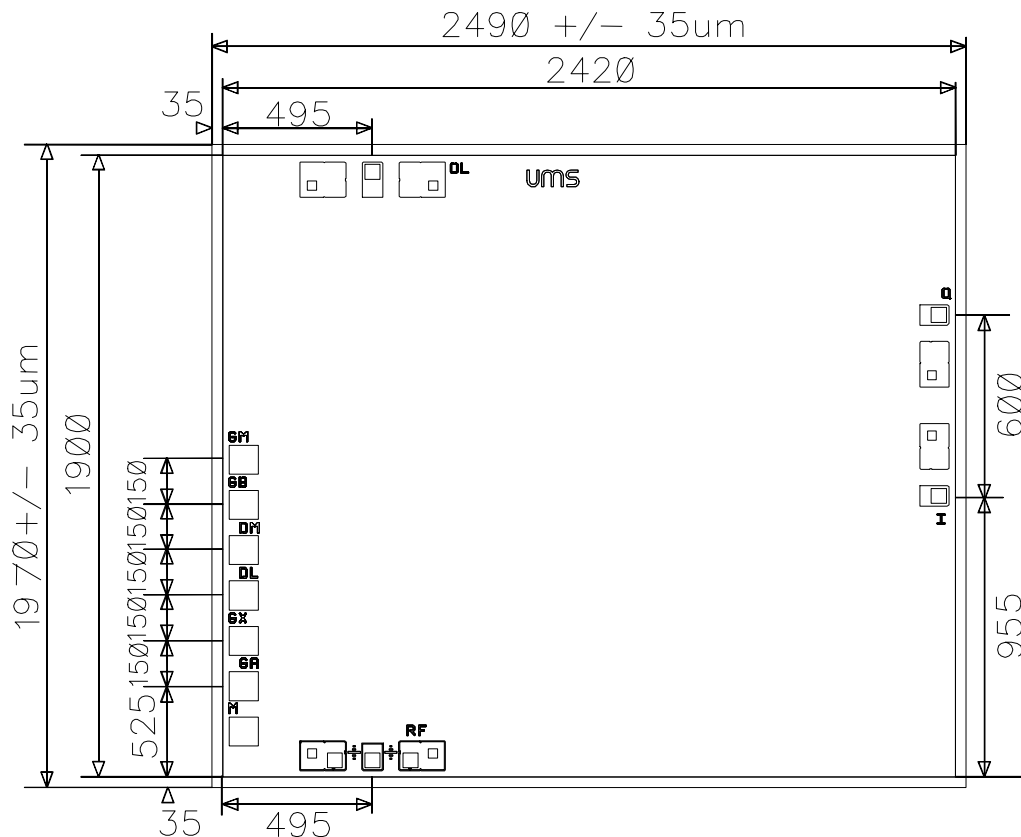

Bonding pad positions

(Chip thickness : 100µm. All dimensions are in micrometers)

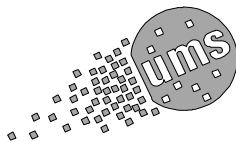

preliminary

Ordering Information

Chip form : CHR2296-99F/00

Information furnished is believed to be accurate and reliable. However **United Monolithic Semiconductors S.A.S.** assumes no responsibility for the consequences of use of such information nor for any infringement of patents or other rights of third parties which may result from its use. No license is granted by implication or otherwise under any patent or patent rights of **United Monolithic Semiconductors S.A.S.** Specifications mentioned in this publication are subject to change without notice. This publication supersedes and replaces all information previously supplied. **United Monolithic Semiconductors S.A.S.** products are not authorised for use as critical components in life support devices or systems without express written approval from **United Monolithic Semiconductors S.A.S.**