

Description

The MIM-R1AA38-1 series are 37.9 KHz miniaturized infrared receivers for remote control and other applications requiring improved ambient light rejection. The separate PIN diode and preamplifier IC are assembled on a single leadframe. The epoxy package contains a special IR filter. This module has excellent performance even in disturbed ambient light applications and provides protection against uncontrolled output pulses.

Package Dimensions



Features

- Photo detector and preamplifier in one package
- Internal filter for PCM frequency
- High immunity against ambient light
- Improved shielding against electric field disturbance
- 5-Volt supply voltage; low power consumption
- TTL and CMOS compatibility

MIM-R1AA38-1

unit : mm

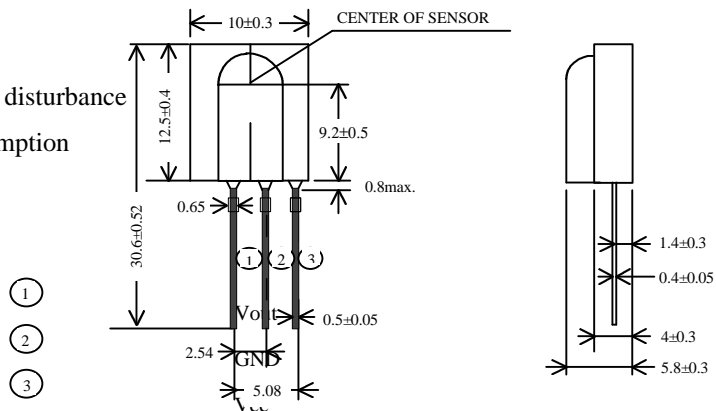

Notes :

1. Tolerance is ± 0.25 mm (.010") unless otherwise noted.
2. Lead spacing is measured where the leads emerge from the package.

BLOCK DIAGRAM

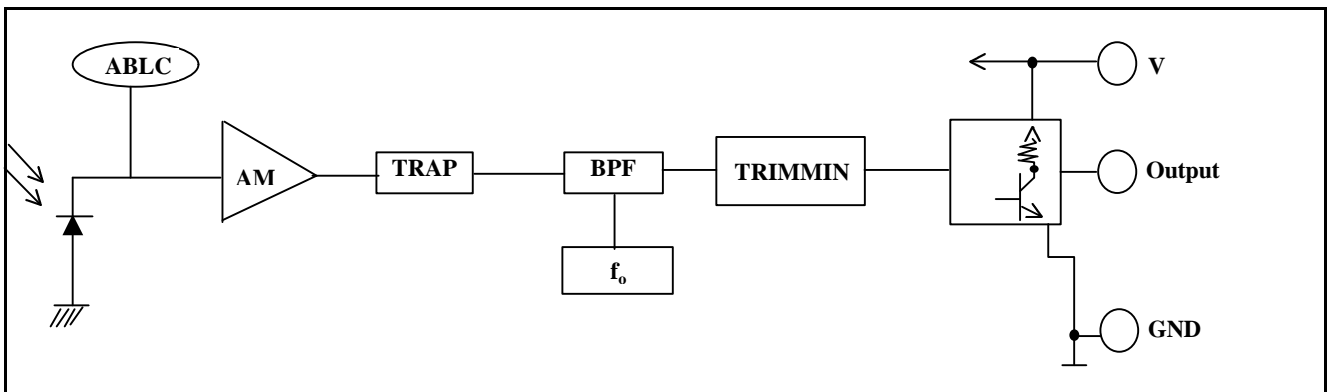

MIM-R1AA38-1

Absolute Maximum Ratings

@ $T_A=25^\circ\text{C}$

Item	Symbol	Ratings	Unit	Remark
Supply voltage	V_{CC}	5.8	V	
Operating temperature	T_{opr}	-10 ~ + 60	$^\circ\text{C}$	
Storage temperature	T_{stg}	-20 ~ + 75	$^\circ\text{C}$	
Soldering temperature	T_{sd}	260	$^\circ\text{C}$	Maximum 5 seconds
Power Dissipation	P_D	17.5	mW	$V_{CC}=+5.0\text{V}$; under no signal

Electro-optical characteristics (Vcc=5V)

@ $T_A=25^\circ\text{C}$

Parameter	Symbol	Min.	Typ.	Max.	Unit	Remarks
Current consumption	I_{cc}			5.0	mA	Under no signal
Response wavelength	λ_p		940		nm	
Tuning frequency	f_0		37.9		KHz	
Output form	----- active low output -----					
H level output voltage	V_{0h}	4.2			V	
L level output voltage	V_{0l}			0.5	V	
H level output pulse width	T_{wh}	400		800	μs	
L level output pulse width	T_{wl}	400		800	μs	
Distance between emitter & detector	L	10.0			m	Note 1
Half angle	$\Delta\theta$	± 16	± 55		deg	Horizontal direction

Test Method

A. Standard Transmitter

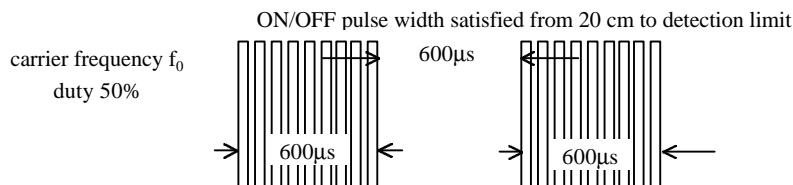

Fig 1. Burst Wave

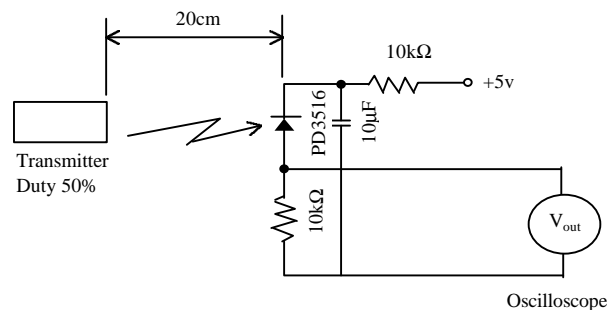
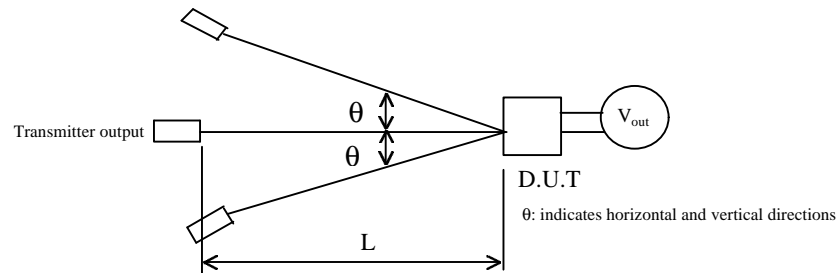
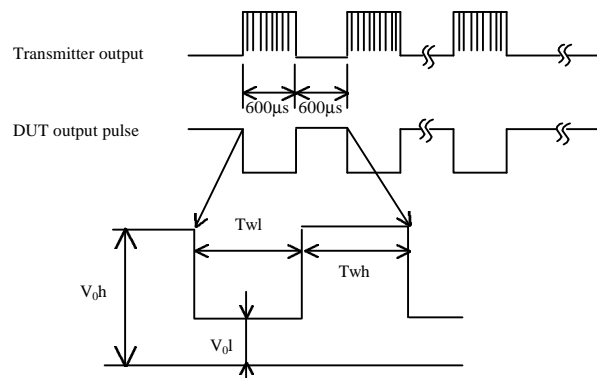

Fig 2. Standard Transmitter Measurement

B. Detection Length Test



C. Pulse Width Test



CHARACTERISTIC CURVES ($T_A=25^\circ C$)

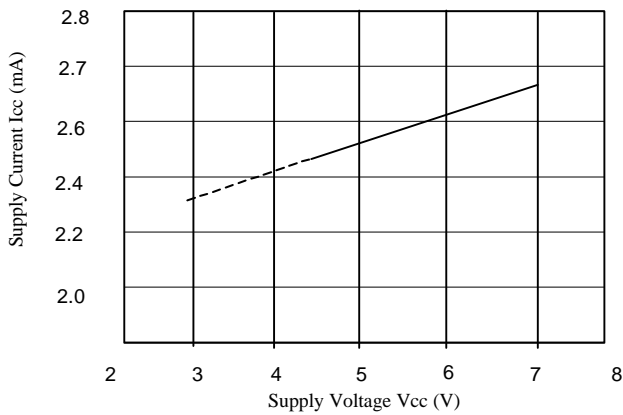

SUPPLY VOLTAGE vs. SUPPLY CURRENT

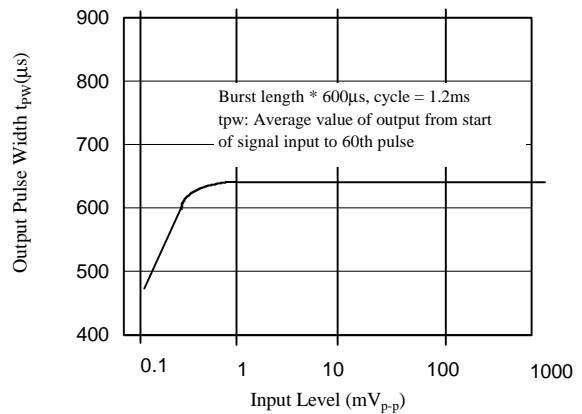

INPUT LEVEL vs. OUTPUT PULSE WIDTH

NOTE 1. Distance between emitter & detector specifies maximum distance that output wave form satisfies

the standard under the conditions below against the standard transmitter.

(1) Measuring placeIndoor without extreme reflection of light.

(2) Ambient light source...Detecting surface illumination shall be 200 ± 50 Lux under ordinary
hite fluorescense lamp of no high frequency lighting.

(3) Standard transmitter ...Burst wave indicated in Fig 1. of standard transmitter

shall be arranged to 50mV_{p-p} under the measuring circuit specified in Fig 2.